

# Mobile Crane / Grue mobile

## **LTM 1250-5.1**

**Strongest 5 axle crane**



**300 USt**



**197 ft**



**315 ft**



**345 ft**



# **LIEBHERR**

# Table of content

## Tables des matières

---

<b>Technical Data</b> <b>Caractéristiques technique</b>	
Dimensions Encombrement	3
Mobile Crane Grue mobile	4 – 5
Liebherr Single-Engine Concept	6 – 7
Variable boom systems Systèmes de flèche variables	8 – 9
Boom/jib combinations Configurations de flèche	10 – 11
Weights/Poids Working speeds/Vitesses	12
Counterweight Contrepoids	13
Lift cab (optional) Cabine élévatrice (en option)	14
Transportation example USA Exemple de transport USA	15 – 16
T	17 – 26
TNZK	27 – 43
TVNZK	44 – 77
TS	78 – 85
TNZF	86 – 100
Equipment Equipement	101 – 102
Description of symbols Explication des symboles	103
Remarks Remarques	104

---

# Dimensions Encombrement

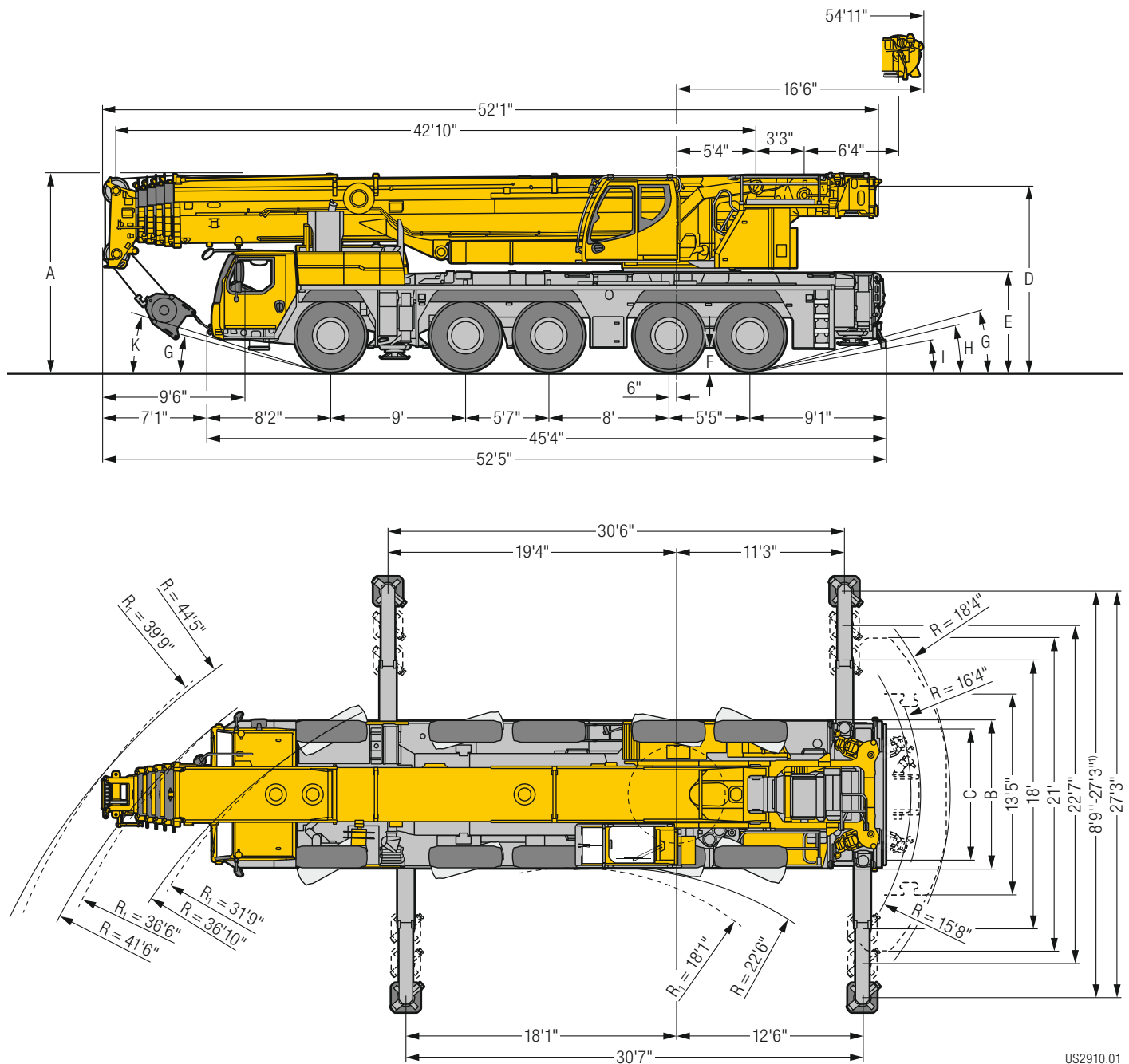

US2910.01

R<sub>1</sub> = All-wheel steering · Direction toutes roues

<sup>1)</sup> only with VarioBase® · seulement avec VarioBase®

## Dimensions/Encombrement

	A	A	B	C	D	E	F	G	H	I	K
		5"*									
445/95 R 25 (16.00 R 25)	13'1"	12'9"	9'10"	8'4"	12'4"	6'7"	1'5"	14°	13°	10°	17°
525/80 R 25 (20.5 R 25)	13'1"	12'9"	10'2"	8'5"	12'4"	6'7"	1'5"	14°	13°	10°	17°

\* lowered · abaissé



# Mobile Crane / Grue mobile

## LTM 1250-5.1



197 ft



18 ft – 118 ft



2 x 23 ft



26 ft – 164 ft



13 ft – 151 ft



194,000 lb

€COmode

€COdrive

ZF-TRAXON

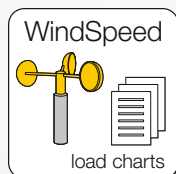
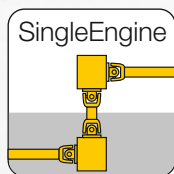
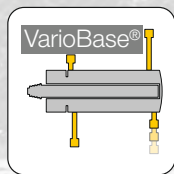

Variable steering concept  
Concept de direction variable

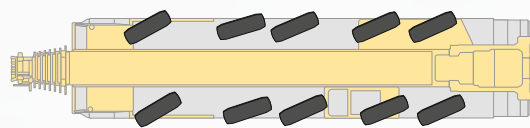

S3196





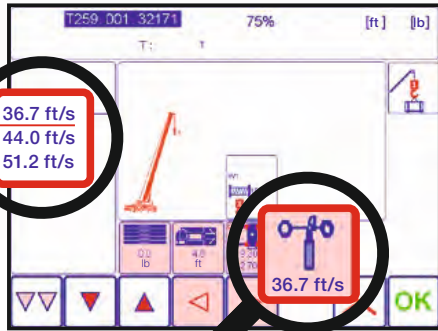
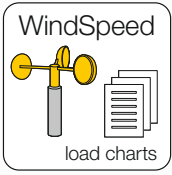

Increased flexibility and safety by using lifting capacity tables with different maximum wind speeds.

Une flexibilité et une sécurité accrues grâce aux tableaux de charge avec différentes vitesses de vent autorisées.



# Fuel saving and noise reduction

## Economie de carburant et réduction du bruit

**Liebherr-6-Zylinder-Motor**  
Liebherr-6-cylinder engine  
**400 kW / 544 PS**  
400 kW / 544 h.p.

**€COdrive**  
**ZF-TRAXON**

Driving strategy in the carrier with ECO- or Powermode to reduce noise and fuel

L'adaptation du mode de déplacement avec le mode ECO ou le mode Puissance permet de réduire le niveau sonore et la consommation de carburant

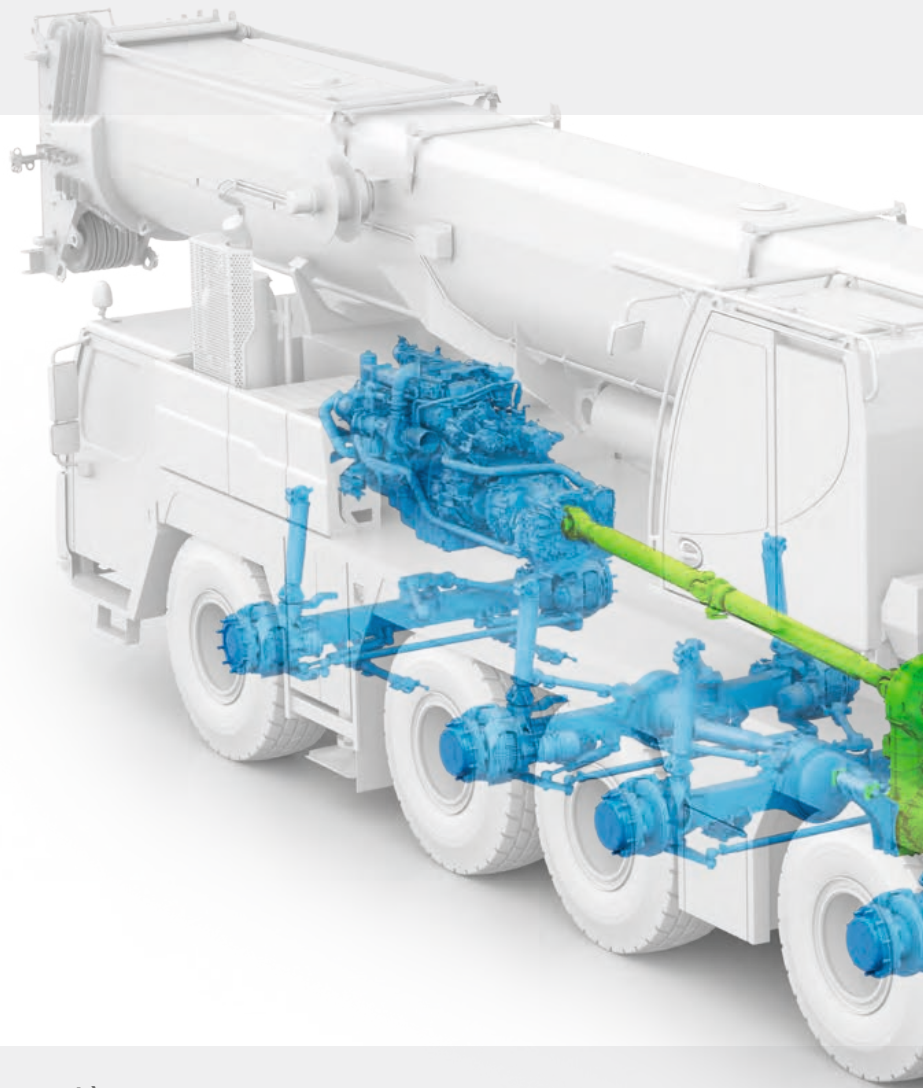

### Innovative One-Engine-Concept

- Drive from chassis engine via a mechanical shaft with special high efficiency factor
- Increased effectiveness and reduced maintenance expenditure

### Concept innovant à moteur unique

- Entraînement du moteur du châssis par le biais d'un arbre mécanique particulièrement performant
- Rentabilité accrue et entretien nettement réduit

### ZF-TraXon

Automated shift gearbox,  
12 forward gears,  
2 reverse gears

### ZF-TraXon

Boîte de vitesses automatisée,  
12 vitesses avant,  
2 vitesses arrière

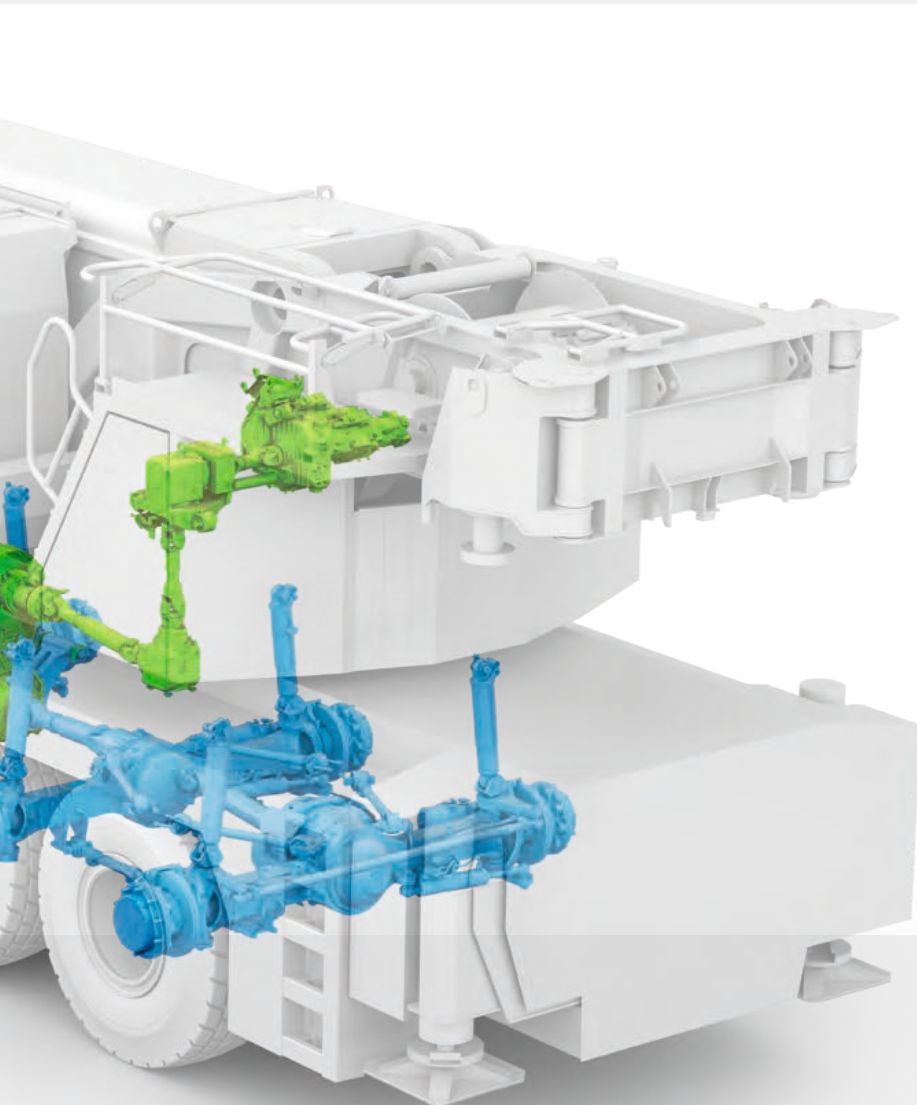

## €COmode

Reduced fuel consumption due to automatic disengaging of the complete pump drive at engine idling with automatic speed adjustment

Réduction de la consommation de carburant par désengagement automatique de l'entraînement complet de la pompe en mode ralenti avec adaptation automatique du régime



# Variable boom systems

## Systèmes de flèche variables

**TVK  
TVNZK**

**TNZF**

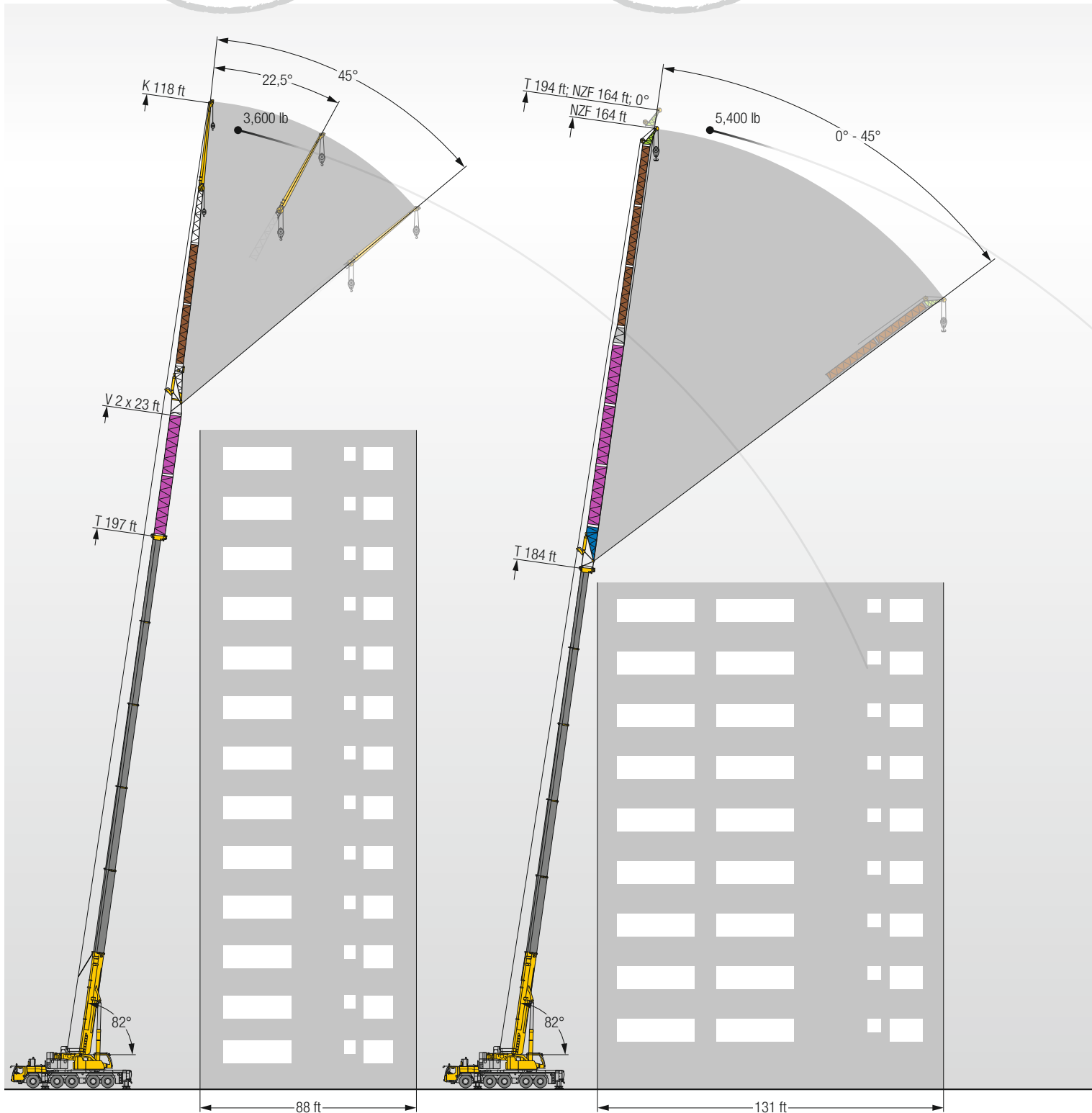



**TS**

**TVK  
TVNZK**

380 ft

**K** 18 ft, 40 ft – 72 ft, 95 ft, 118 ft  
0°; 22,5°; 45°

72 ft double swing away jib, can technically be carried on crane

360

**NZK** 18 ft, 40 ft – 72 ft, 95 ft, 118 ft  
0° – 45°

Double fléchette pliante de 72 ft avec maintien à demeure sur la grue

340

**V** 2 x 23 ft

320

**TNZF TS**

**NZF** 26 ft – 164 ft  
0° – 45°

Fixed jib contains strong jip  
Fléchette fixe avec fléchette robuste

300

**S** 13 ft – 151 ft  
0°

280

260

**TS**

**S** 13 ft – 151 ft  
0°

Strong system for steep working positions  
Système le plus performant pour les positions de travail les plus raides

240

220

200

180

160

140

120

100

80

60

40

20

0

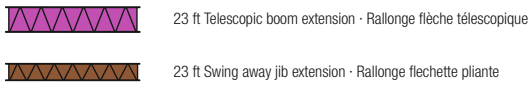
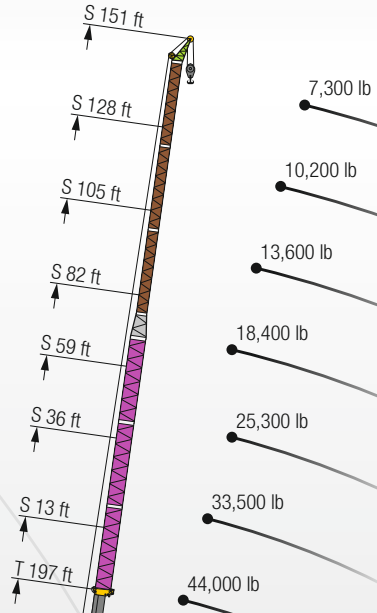

US2993.02

# Boom/jib combinations Configurations de flèche

**TS**

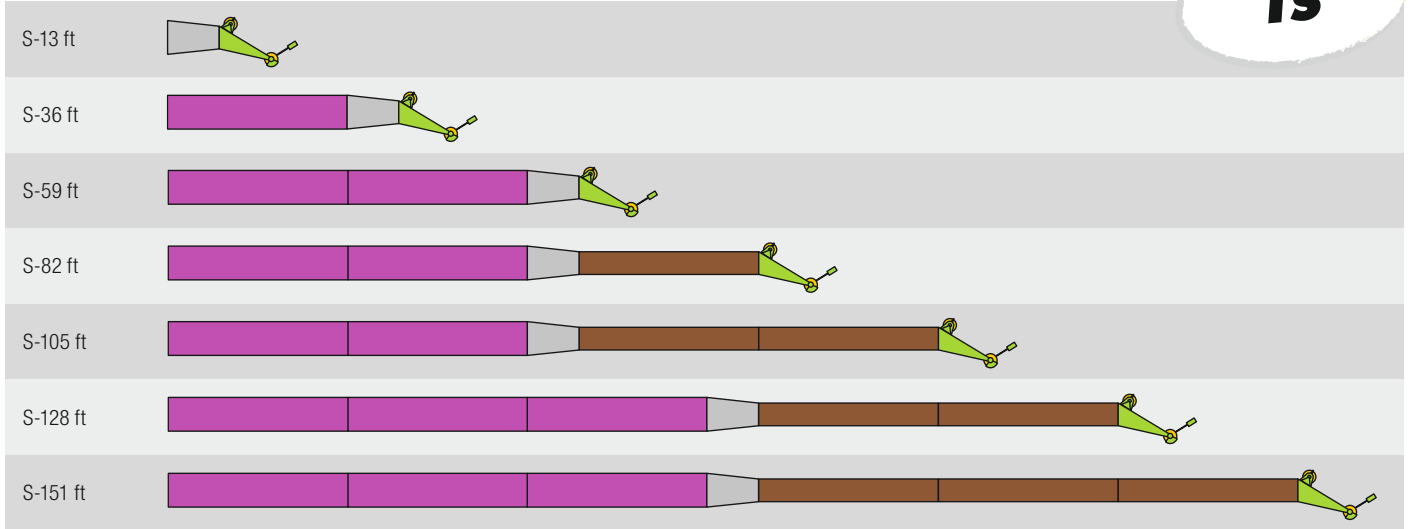

US2992

**TNZF**

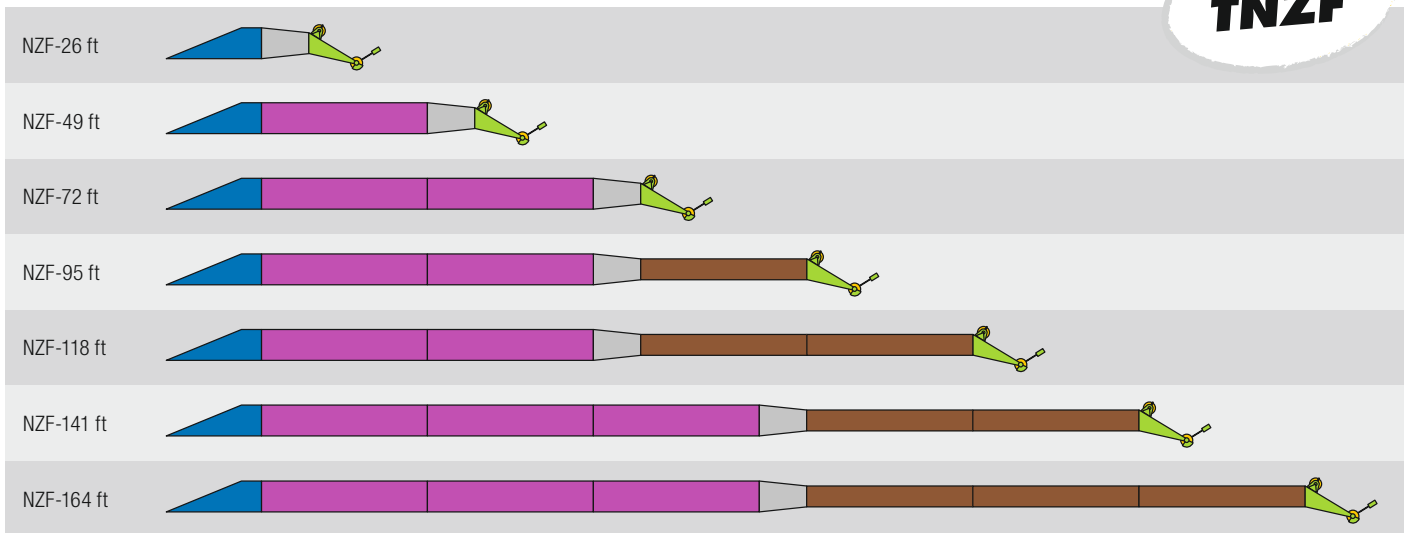

13 ft F-shaped base section · Élément de base F



23 ft Telescopic boom extension · Rallonge flèche télescopique



6.5 ft Reduction section · Élément réducteur



23 ft Swing away jib extension · Rallonge flechette pliante



6.5 ft F head section · Élément de tête F

US2991

# Boom/jib combinations Configurations de flèche

- T** Telescopic boom/Flèche télescopique
- K** Swing away jib/Flechette pliante
- NZK** Hydraulic swing away jib/Fléchette pliante hydraulique
- V** Telescopic boom extension/Rallonge de flèche télescopique
- S** Strong jib/Fléchette particulièrement puissante
- NZF** Hydraulic lattice jib/Fléchette treillis hydraulique



**T**  
17 – 26

**TK/TNZK**  
27 – 43

**TVK/TVNZK**  
44 – 77

**TS**  
78 – 85





**TNZF**  
86 – 100

S2981







# Weights Poids

## Hook block/Moufles à crochet

			
332,900 lb	9	16	4,400 lb
314,480 lb	7	15	3,750 lb
237,450 lb	5	11	3,530 lb
155,650 lb	3	7	3,200 lb
68,780 lb	1	3	1,850 lb
23,150 lb	–	1	1,100 lb

# Working speeds Vitesses











## Crane carrier/Châssis porteur

	 min.	 max.	 %
445/95 R 25 (16.00 R 25) 525/80 R 25 (20.5 R 25)	0.3	53	55.4 %

Theoretical gradeability/Aptitude théorique en pente

	
	12 / R2
	4 / R2

## Crane superstructure/Partie tournante

	 max			 F
	0 – 440 ft/min single line ft/min au brin simple	0.8" / 1150 ft		23,605 lb
	0 – 440 ft/min single line ft/min au brin simple	0.8" / 920 ft		23,605 lb
	0 – 1.4 rpm			
	approx. 55 seconds to reach 82° boom angle env. 55 s jusqu'à 82°			
	approx. 450 seconds for boom extension from 43 ft – 197 ft env. 450 s pour passer de 43 ft – 197 ft			

# Counterweight Contrepoids

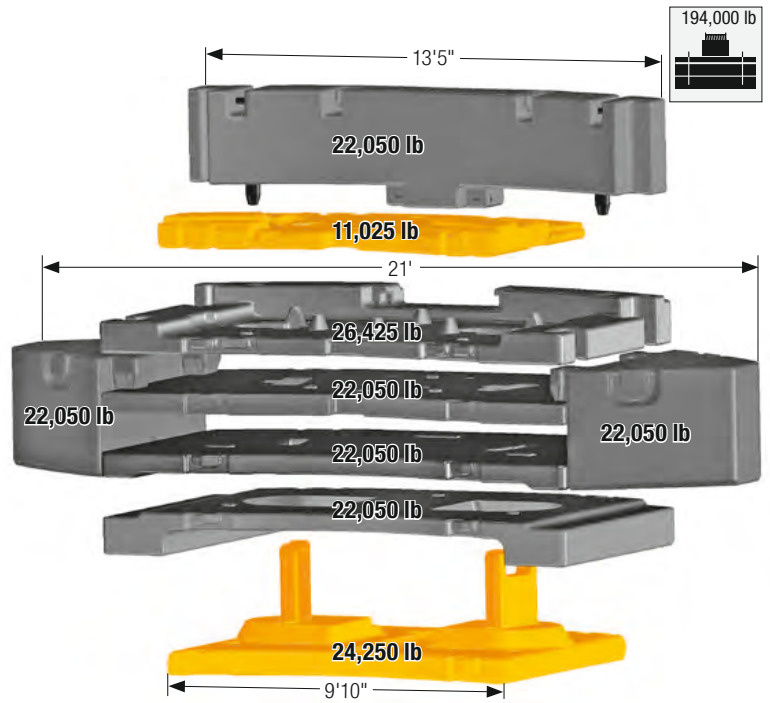
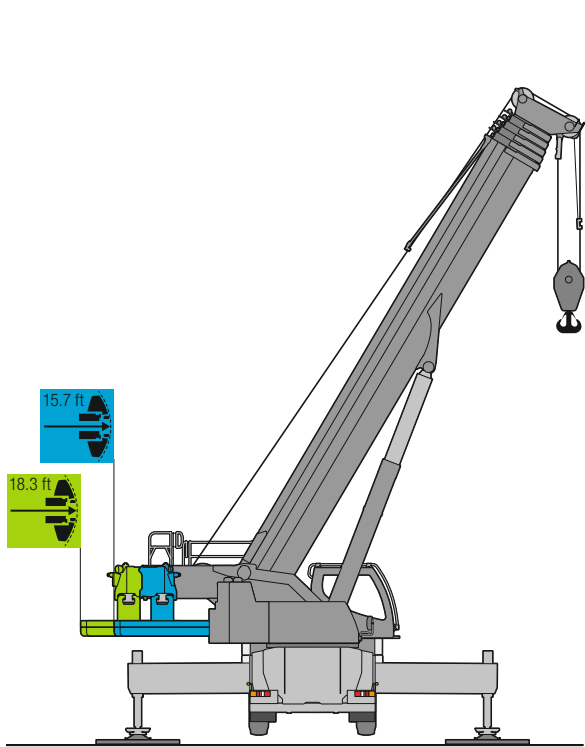

Technically transportable - Transport techniquement simplifié

## Axle/Essieu

	1	2	3	4	5	
						
lb	26,400	26,400	26,400	26,400	26,400	132,000 <sup>1)</sup>

<sup>1)</sup> with sheave set - avec jeu de poulies

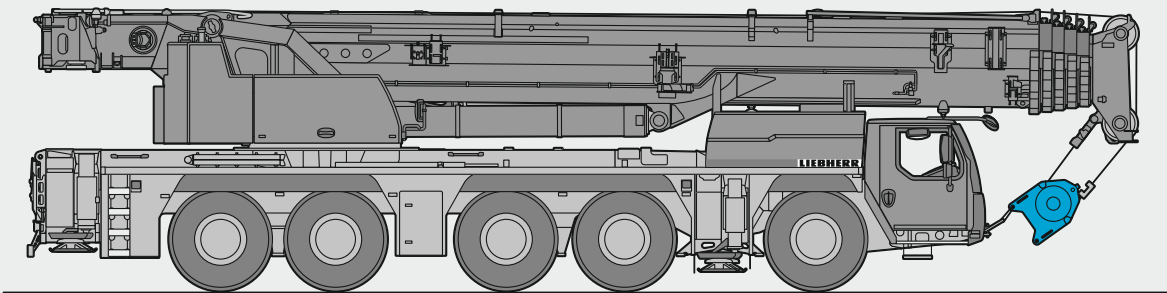

S2967

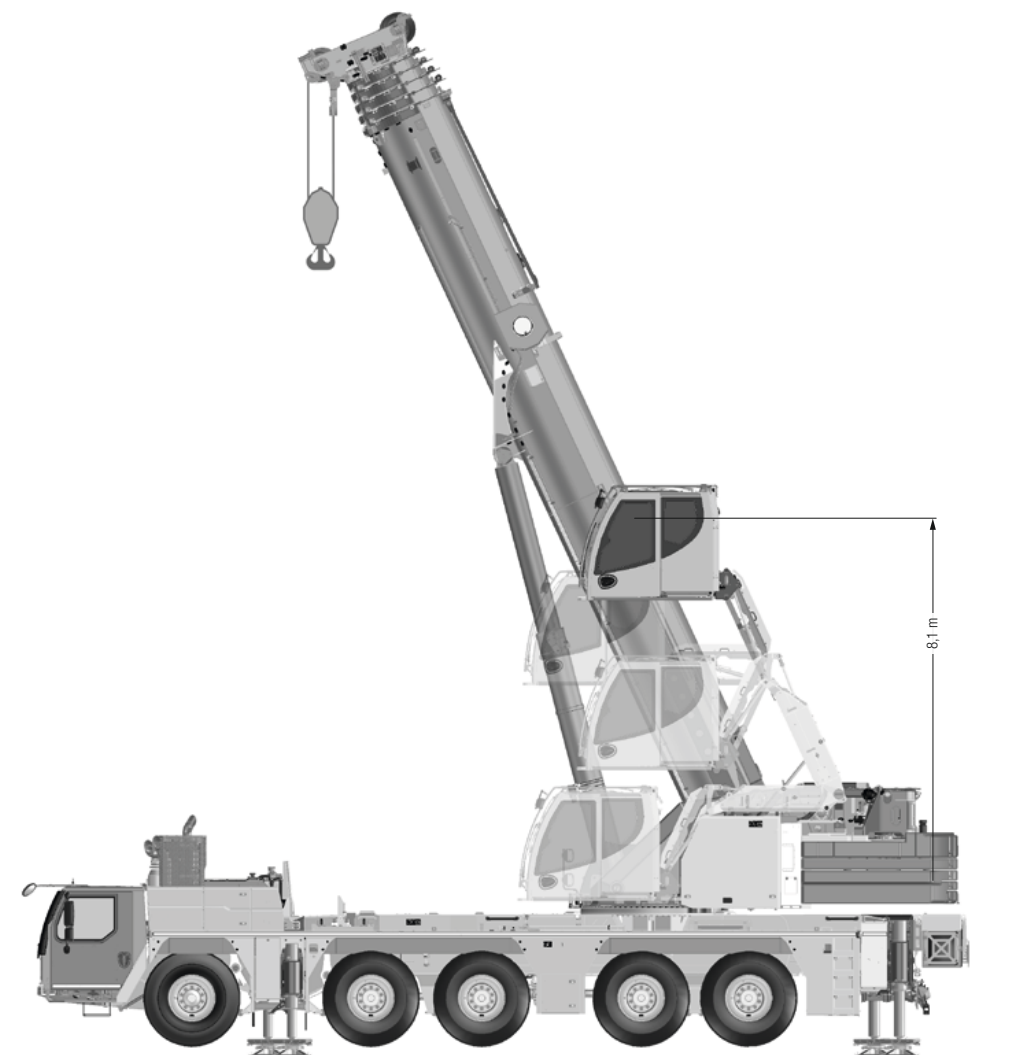

# Lift cab (optional) Cabine élévatrice (en option)

- Better view  
Meilleur champ de vision
- Increased safety  
Sécurité accrue



S3237

## Axle / Essieu

	1	2	3	4	5	
lb	26,400	26,400	26,400	26,400	26,400	132,000 <sup>1)</sup>

<sup>1)</sup> without rear left sliding strut · sans barre coulissante à l'arrière à gauche

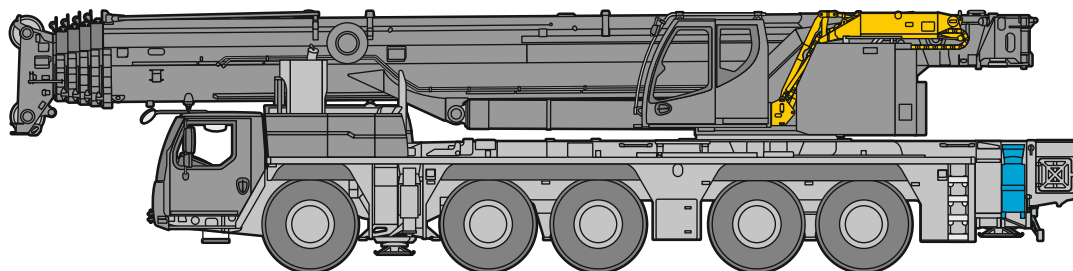

S3238.01



# Transportation example Exemple de transport

20 t / 44,100 lb

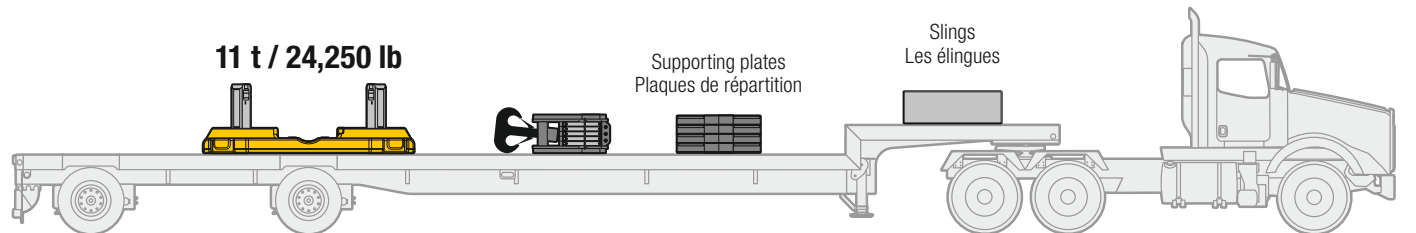

20 t / 44,100 lb

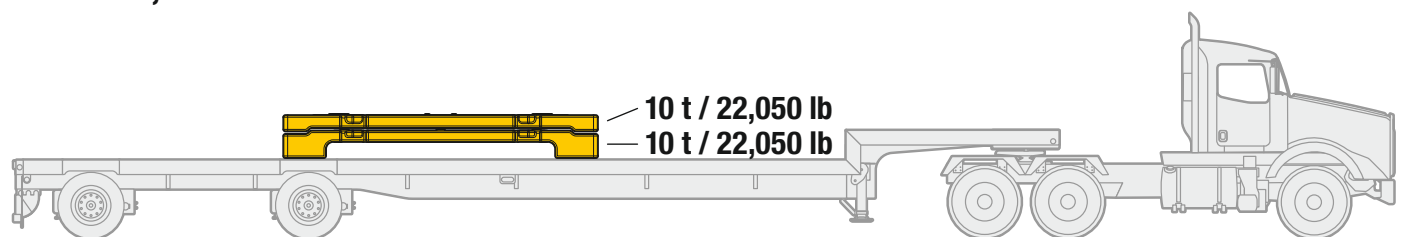

20 t / 44,100 lb

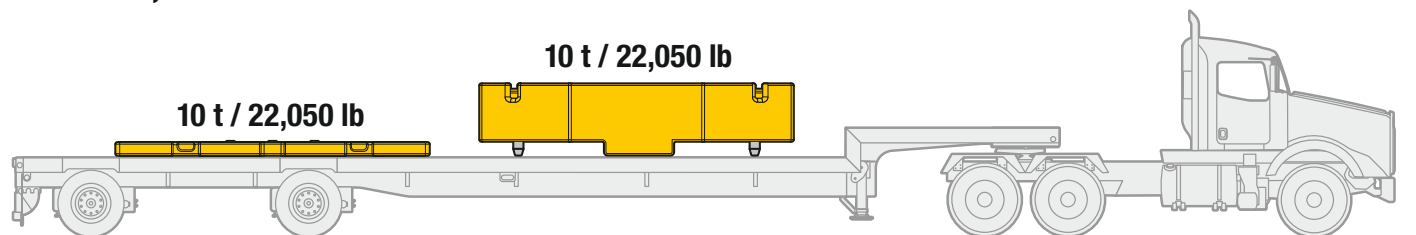

# Transportation example

## Exemple de transport

20 t / 44,100 lb

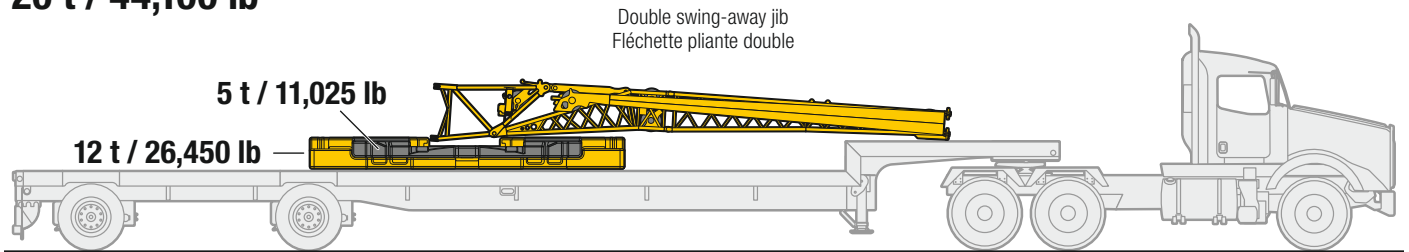

20 t / 44,100 lb

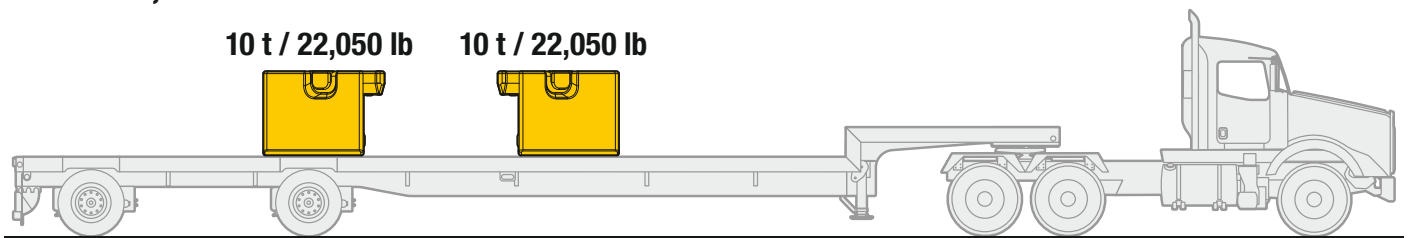

# Lifting capacities

## Forces de levage

T

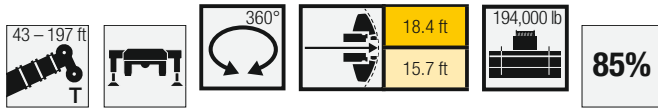

	43 ft	57 ft	71 ft	74 ft	85 ft	99 ft	114 ft	128 ft	142 ft	156 ft	170 ft	180 ft	184 ft	194 ft	197 ft		
9	600															9	
10	551.2	295.4	266.6	265.2	265.1											10	
11	381.9	295.4	267.7	266.1	266											11	
12	312.5	295.4	268.9	267	266.9	258.5										12	
13	309.7	295.4	270.2	268	267.2	260.1										13	
14	306.7	288.8	271.7	269	264.1	261										14	
15	303.7	279.3	273.2	269.5	263.2	262.1	226.6									15	
16	300.3	269	268.1	267.8	261.9	258.9	243.9									16	
17	292.1	259	259.3	258.6	256.2	253	239.8									17	
18	281.7	249.6	249.8	249.7	246.6	243.8	234.6									18	
19	271	240.7	241.1	240.9	237.6	235.1	226.9	203.4								19	
20	261.1	232.3	233.6	232.6	229.3	227.3	220.8	202.6								20	
22	242.9	216.9	218.4	218.5	213.9	216.3	210.3	197.7	154							22	
24	226.6	203.1	204.5	204.9	199.9	205.2	197.7	188.1	150.7							24	
26	211.7	190.7	192.2	192.5	187.4	193.5	186.6	178.5	146.4	122.6						26	
28	197.7	179.6	181.1	181.4	176.4	182.5	177	170	141.3	120.1	90.7					28	
30	184.1	169.7	171.1	171.4	166.4	172.7	168.4	161.7	135.6	117.5	99.9					30	
32	170.2	160.7	162.1	162.3	157.3	163.8	160.7	154	129.7	114.5	98.4	75.3				32	
34	155	152.3	153.8	154.1	149.4	155.5	153.7	147.2	124.3	111.6	96.6	79.2				34	
36	135.5	135.5	145.9	146.2	142.4	147.6	146.8	140.9	119.4	108.8	94.7	78.2	62.4	64.3		36	
38			138.8	139.7	135.8	140.5	139.8	135.3	115.3	105.6	92.7	77.1	61.7	63.8		38	
40			132.1	133.7	129	133.9	133.1	130.2	111.3	101.9	90.6	76	60.8	63.1	55.2	53.9	40
45			118.3	119.2	114.2	119.2	118.3	116.9	102.4	93.1	84.7	72.7	58.1	61	53.7	52.4	45
50			94.6	106.7	101.2	106.7	105.8	104.4	94.4	85.5	79	68.9	55.1	58.6	51.8	50.4	50
55				95.7	90.2	95.6	94.8	93.2	87.3	78.7	73.3	65.4	52.1	56.1	49.7	48.7	55
60				86.4	80.9	86.5	85.5	84	81.4	72.6	67.9	62.3	49.2	53.6	47.7	46.9	60
65				63.9	70.8	78.4	77.4	75.8	75.8	67.8	63.1	59	46.6	51.3	45.6	44.9	65
70						71.3	70.2	68.6	70.1	63.7	58.8	55.7	44.2	49	43.6	43	70
75						64.4	64	63.4	63.9	59.9	55.1	52.4	41.9	46.9	41.6	41.2	75
80						41.7	58.7	59.9	58.5	56.6	52.1	49.3	39.8	44.8	39.8	39.4	80
85							54.1	55.3	53.8	53.3	49.3	46.6	37.9	42.8	38	37.6	85
90							49.4	51.3	49.7	49.3	46.6	43.9	36.2	40.9	36.4	36	90
95								47.6	46.1	45.7	43.9	41.4	34.5	39.1	34.8	34.4	95
100								44.5	42.9	42.5	41.7	39.2	32.9	37.2	33.4	33	100
105								38.4	40.2	40.5	39.8	37.1	31.5	35.5	32	31.5	105
110									37.9	38	37.5	35.2	30.1	33.7	30.8	30.2	110
115									35.5	35.5	35.1	33.7	28.8	32	29.6	28.9	115
120									30.4	33.3	32.8	32	27.5	30.5	28.4	27.7	120
125										31.3	30.8	30	26.4	29.1	27.3	26.5	125
130										29.5	29	28.7	25.3	27.7	26.3	25.5	130
135										23.3	27.7	27.1	24.3	26.2	25.3	24.5	135
140											26.2	25.6	23.4	24.6	24.4	23.5	140
145											24	24.1	22.5	23.1	23.2	22.6	145
150											16.6	22.8	21.7	21.7	21.9	21.6	150
155												21.5	21	20.4	20.6	20.4	155
160												18.8	20.3	19.3	19.4	19.2	160
165												9.3	19.4	18.2	18.3	18.1	165
170													16.6	17.1	17.3	17.1	170
175														13.8	16.3	16.1	175
180															15.3	15.2	180
185															12	13.4	185
190																8.4	190

\* ± 0° over rear - en arrière

t\_259\_101\_10003 / 12201 / 32201\_00\_000



# Lifting capacities

## Forces de levage

T

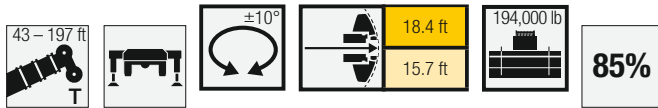

	43 ft	57 ft	71 ft	74 ft	85 ft	99 ft	114 ft	128 ft	142 ft	156 ft	170 ft	180 ft	184 ft	194 ft	197 ft	
10	295.4	266.6	265.2	265.1												10
11	295.4	267.7	266.1	266												11
12	295.4	268.9	267	266.9	258.5											12
13	295.4	270.2	268	267.2	260.1											13
14	295.4	271.7	269	264.1	261											14
15	295.4	273.2	270.1	263.2	262.1	226.6										15
16	295.1	274.3	270.8	262.8	258.9	243.9										16
17	291.2	274.3	262.8	257.8	253	239.8										17
18	281.7	267.2	254.4	248.1	243.8	234.6										18
19	271	259.3	245.6	239.2	235.1	226.9	203.4									19
20	261.1	250.8	237.6	231.1	227.3	220.8	202.6									20
22	242.9	235.1	225.1	216.7	216.3	210.3	197.7	154								22
24	226.6	221	212.8	204.1	205.3	197.7	188.1	150.7								24
26	211.7	207.8	201.2	193.1	194.3	186.6	178.5	146.4	122.6							26
28	197.7	195.9	189.9	182.3	184.6	177	170	141.3	120.1	90.7						28
30	184.1	185	179.7	172.2	176.1	168.4	161.7	135.6	117.5	99.9						30
32	170.2	175.1	170.5	163.1	167.7	160.7	154	129.7	114.5	98.4	75.3					32
34	155	165.6	162.2	154.8	159.7	154	147.2	124.3	111.6	96.6	79.2					34
36	135.5	155.7	154.4	147.1	152.2	147.5	140.9	119.4	108.8	94.7	78.2	62.4	64.3			36
38		146.6	147	139.8	145.5	141.2	135.3	115.3	105.6	92.7	77.1	61.7	63.8			38
40		138.4	138.8	132.4	139.3	135.1	130.2	111.3	101.9	90.6	76	60.8	63.1	55.2	53.9	40
45		121.4	121.6	117.7	123.3	121.8	117.7	102.4	93.1	84.7	72.7	58.1	61	53.7	52.4	45
50		94.6	109.5	103.9	109.5	108.6	106.7	94.4	85.5	79	68.9	55.1	58.6	51.8	50.4	50
55			98.2	92.6	98.1	97.3	95.7	87.3	78.7	73.3	65.4	52.1	56.1	49.7	48.7	55
60			87	83.3	88.8	87.8	86.3	81.4	72.6	67.9	62.3	49.2	53.6	47.7	46.9	60
65			63.9	70.8	80.8	79.9	78.3	75.8	67.8	63.1	59	46.6	51.3	45.6	44.9	65
70					74	73.1	71.5	71.7	63.7	58.8	55.7	44.2	49	43.6	43	70
75					64.5	67.2	65.6	67.1	59.9	55.1	52.4	41.9	46.9	41.6	41.2	75
80					41.7	62	60.4	61.8	56.6	52.1	49.3	39.8	44.8	39.8	39.4	80
85						57.3	57.1	57.3	53.5	49.3	46.6	37.9	42.8	38	37.6	85
90						49.4	54.5	53.3	50.8	46.6	43.9	36.2	40.9	36.4	36	90
95							51.2	49.6	48.2	43.9	41.4	34.5	39.1	34.8	34.4	95
100							46.8	46.3	45.8	41.7	39.2	32.9	37.2	33.4	33	100
105							38.4	43.1	42.5	39.8	37.1	31.5	35.5	32	31.5	105
110								40.2	39.5	38.1	35.2	30.1	33.7	30.8	30.2	110
115								36.4	37.8	36.4	33.7	28.8	32	29.6	28.9	115
120								30.4	35.8	35	32.2	27.5	30.5	28.4	27.7	120
125									33.6	33.1	30.6	26.4	29.1	27.3	26.5	125
130									29.6	31	29.2	25.3	27.7	26.3	25.5	130
135									23.3	29.2	27.9	24.3	26.4	25.3	24.5	135
140										27.4	26.8	23.4	25.2	24.4	23.5	140
145										24	25.8	22.5	24.1	23.4	22.6	145
150										16.6	24.4	21.7	23.1	22.5	21.8	150
155											22.8	21	21.9	21.5	20.9	155
160												18.8	20.3	20.6	20.2	160
165												9.3	19.7	19.5	19.4	165
170													16.6	17.7	18.5	170
175														13.8	17.5	175
180															15.7	180
185															12	185
190															8.4	190

t\_259\_101\_11201 / 31201\_00\_000

# Lifting capacities

## Forces de levage

T

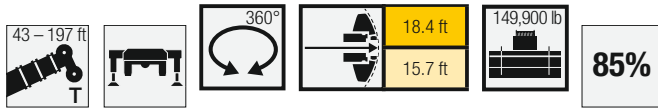

	43 ft	57 ft	71 ft	74 ft	85 ft	99 ft	114 ft	128 ft	142 ft	156 ft	170 ft	180 ft	184 ft	194 ft	197 ft	
10	295.4	266.6	265.2	265.1												10
11	295.4	267.7	266.1	266												11
12	295.4	268.9	267	266.9	258.5											12
13	295.4	270.2	268	267.2	260.1											13
14	287.9	271.7	269	264.1	261											14
15	277.5	272.7	269	263.2	262.1	226.6										15
16	266.4	266	265.2	260.4	258.9	243.9										16
17	256.3	256.6	256.2	253.3	253	239.8										17
18	246.6	246.8	246.7	243.4	243.8	234.6										18
19	237.4	237.8	237.6	234.2	235.1	226.9	203.4									19
20	228.7	230	229.7	225.6	227.2	220.8	202.6									20
22	213.1	214.6	214.7	210.1	214.7	210.3	197.7	154								22
24	199.5	201	201.3	196.3	202.3	197.7	188.1	150.7								24
26	187.1	188.6	188.9	183.6	190.1	186.6	178.5	146.4	122.6							26
28	175.4	177	177.6	172.8	178.6	176.9	170	141.3	120.1	90.7						28
30	164.8	166.4	168.2	163.2	168.2	167.4	161.7	135.6	117.5	99.9						30
32	155	156.7	158.5	153.8	158.7	157.7	154	129.7	114.5	98.4	75.3					32
34	146.2	147.9	149.6	144.6	149.7	148.9	146.5	124.3	111.6	96.6	79.2					34
36	135.5	140.1	141.2	135.7	141.2	140.3	138.3	119.4	108.8	94.7	78.2	62.4	64.3			36
38		131.9	132.9	127.5	133	132.3	130.7	115.3	105.6	92.7	77.1	61.7	63.8			38
40		124.5	125.5	120	125.7	124.8	123.4	111.3	101.9	90.6	76	60.8	63.1	55.2	53.9	40
45		107.8	109	102.9	109.1	108	106.4	102.4	93.1	84.7	72.7	58.1	61	53.7	52.4	45
50		93.4	94.6	91.1	94.6	93.7	92.1	91.8	85.5	79	68.9	55.1	58.6	51.8	50.4	50
55			83.2	79.7	83.1	82.2	81.3	82.2	78.7	73.3	65.4	52.1	56.1	49.7	48.7	55
60			74	70.6	73.9	73	74.5	73	72.1	67.9	62.3	49.2	53.6	47.7	46.9	60
65			63.9	63.1	66.3	65.3	66.8	65.3	64.9	62.8	59	46.6	51.3	45.6	44.9	65
70					60	60.9	60.4	59.5	58.5	57.7	55.7	44.2	49	43.6	43	70
75					54.7	56	55	54.1	53.5	53.5	52	41.9	46.9	41.6	41.2	75
80					41.7	51.3	50.3	49.4	49.6	49.3	47.8	39.8	44.8	39.8	39.4	80
85						47.3	46.3	45.5	45.7	45.1	43.9	37.9	42.8	38	37.6	85
90						43.8	42.6	43.2	42.2	41.4	40.7	36.2	40.1	36.4	36	90
95							39.4	40	39	38.6	38.1	34.5	37.2	34.8	34.4	95
100							36.5	37.1	36	35.7	35.2	32.9	34.3	33.4	33	100
105							34.7	34.5	33.4	33.3	32.6	31.5	31.7	31.6	31.3	105
110								32.1	31.6	31.1	30.2	30	29.3	29.5	29.3	110
115								30.1	29.8	29	28.1	28.4	27.1	27.3	27.1	115
120								28.2	27.9	27.1	26.1	26.4	25.2	25.4	25.2	120
125									26.1	25.3	24.4	24.7	23.4	23.6	23.4	125
130									24.6	23.7	22.7	23	21.8	21.9	21.8	130
135									23.1	22.2	21.2	21.5	20.3	20.5	20.3	135
140										20.9	19.9	20.1	18.9	19.1	18.9	140
145										19.7	18.6	18.9	17.6	17.8	17.6	145
150										16.6	17.5	17.7	16.4	16.6	16.4	150
155											16.4	16.6	15.4	15.5	15.3	155
160											15.5	15.6	14.3	14.5	14.3	160
165											9.3	14.7	13.4	13.5	13.3	165
170												13.8	12.5	12.6	12.4	170
175													11.7	11.8	11.6	175
180														11	10.9	180
185														10.3	10.1	185
190															8.4	190

t\_259\_101\_12004 / 32004\_00\_000

# Lifting capacities

## Forces de levage

T

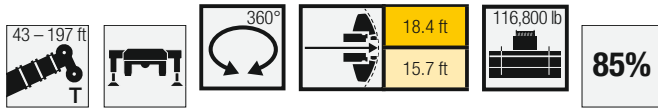

	43 ft	57 ft	71 ft	74 ft	85 ft	99 ft	114 ft	128 ft	142 ft	156 ft	170 ft	180 ft	184 ft	194 ft	197 ft	
10	295.4	266.6	265.2	265.1												10
11	295.4	267.7	266.1	266												11
12	295.4	268.9	267	266.9	258.5											12
13	294.9	270.2	268	267.2	260.1											13
14	285.5	271.7	269	264.1	261											14
15	273.5	270.1	268.1	263.2	262.1	226.6										15
16	262.1	261.7	262.2	257.8	258	243.9										16
17	251.7	252	251.9	248.7	250.9	239.8										17
18	242	242.2	242.2	238.9	241.6	234.6										18
19	233	233.5	233.2	229.8	233	226.9	203.4									19
20	224.5	225.8	226	221.4	225.4	220.8	202.6									20
22	208.5	210.2	210.3	205.3	211	210.2	197.7	154								22
24	194	195.6	196.4	192.7	197.1	196.4	188.1	150.7								24
26	180.6	182.3	184.1	179.2	183.9	183.1	176.2	146.4	122.6							26
28	168.1	169.8	171.8	166.5	171.9	170.9	164.2	141.3	120.1	90.7						28
30	155.6	158	159.8	154.3	159.9	158.9	153	135.6	117.5	99.9						30
32	144.6	147.7	148.8	143.1	149	148	142.8	129.7	114.5	98.4	75.3					32
34	134.2	137.5	138.7	132.5	138.7	137.8	133.6	124.3	111.6	96.6	79.2					34
36	123.7	127.3	128.7	122.3	128.8	127.8	124.4	119.4	108.8	94.7	78.2	62.4	64.3			36
38		117.9	119.2	115.2	119.4	118.6	116.1	112.2	105.6	92.7	77.1	61.7	63.8			38
40		109.6	110.9	107.3	111.1	110.2	108.4	105.2	101.9	90.6	76	60.8	63.1	55.2	53.9	40
45		92.8	94.1	90.5	94.2	93.2	93.3	92.7	89.3	84.3	72.7	58.1	61	53.7	52.4	45
50		80.2	81.4	77.9	81.4	80.6	82.2	80.8	78.4	74.7	68.9	55.1	58.6	51.8	50.4	50
55			71.3	68.6	71.3	72.9	71.9	71.1	69.4	66.9	64.8	52.1	56.1	49.7	48.7	55
60			63.3	62.1	63.2	64.8	63.8	63	62.8	61.5	58.5	49.2	53.6	47.7	46.9	60
65			56.8	55.6	57.1	58.1	57.1	57.1	56.8	55.5	52.8	46.6	50.5	45.6	44.9	65
70					52.7	52.4	51.4	52.1	51.1	50.2	49	44.2	46.6	43.6	43	70
75					47.8	47.5	46.6	47.2	46.2	45.9	44.7	41.9	42.3	41	40.6	75
80					41.7	43.3	43.7	42.9	42.5	42	40.9	39.7	38.6	37.9	37.5	80
85						39.6	40	39.2	39	38.3	37.4	37.1	35.3	34.8	34.3	85
90						36.5	36.8	36	35.8	35	34	34.1	32.4	31.9	31.5	90
95							34	33.4	32.9	32.2	31.1	31.3	29.8	29.4	29	95
100							31.5	31	30.4	29.6	28.5	28.7	27.3	27.1	26.7	100
105							29.3	28.7	28.1	27.3	26.1	26.3	24.9	24.9	24.6	105
110								26.7	26.1	25.2	24	24.2	22.8	22.8	22.6	110
115								24.9	24.2	23.3	22.1	22.3	20.9	21	20.7	115
120								23.3	22.5	21.6	20.4	20.6	19.2	19.2	19	120
125									21	20	18.8	19	17.6	17.7	17.5	125
130									19.7	18.6	17.4	17.6	16.2	16.3	16	130
135									18.5	17.3	16.1	16.3	14.9	15	14.7	135
140										16.2	14.9	15.1	13.7	13.8	13.5	140
145										15.1	13.9	14	12.6	12.7	12.4	145
150										14.1	12.9	13	11.6	11.6	11.4	150
155											12	12	10.7	10.7	10.5	155
160											11.2	11.2	9.8	9.8	9.6	160
165											9.3	10.4	9	9	8.8	165
170												9.7	8.3	8.3	8.1	170
175													7.6	7.6	7.4	175
180														7.1	6.9	180
185														6.5	6.2	185
190															5.7	190

t\_259\_101\_12007 / 32007\_00\_000

# Lifting capacities

## Forces de levage

T

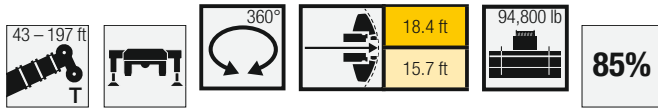

	43 ft	57 ft	71 ft	74 ft	85 ft	99 ft	114 ft	128 ft	142 ft	156 ft	170 ft	180 ft	184 ft	194 ft	197 ft	
10	295.4	266.6	265.2	265.1												10
11	295.4	267.7	266.1	266												11
12	295.4	268.9	267	266.9	258.5											12
13	292.8	270.2	268	267.2	260.1											13
14	281.8	271.7	269	264.1	261											14
15	269.7	267.7	267.4	262.8	262.1	226.6										15
16	258.4	258.8	258.6	255.6	256	243.9										16
17	248.2	248.5	248.4	245.2	248.2	239.4										17
18	238.5	238.9	238.8	235.4	238.5	233.6										18
19	229	229.5	229.4	225.6	229.1	224.6	203.4									19
20	219.9	221.3	221.6	217.3	221	216.6	202.6									20
22	202.8	204.6	206.1	201.6	206.1	202.9	192.8	154								22
24	186.9	188.9	190.6	185.5	190.8	186.7	177.3	150.7								24
26	171.1	173.3	175.5	169.7	175.3	171.7	160.7	145.8	122.6							26
28	156.7	160.1	161.4	155.3	161.3	156.2	146.2	138	120.1	90.7						28
30	142.4	146.3	147.9	140.9	147.7	142.9	134.4	128.1	117.5	99.9						30
32	129.1	133	134.4	130.1	134.9	131.4	124.7	119	112.6	98.4	75.3					32
34	117.8	121.6	123	119.3	123.3	121.6	115.5	112.2	106.2	96.6	79.2					34
36	108.2	111.8	113.2	109.6	113.3	112.3	108.2	104.5	100.3	94.2	78.2	62.4	64.3			36
38		103.4	104.7	101.1	104.9	104.1	103.7	98.7	93.9	89.3	77.1	61.7	63.8			38
40		96	97.4	93.8	97.6	96.6	97.4	92.7	88.1	83.8	76	60.8	63.1	55.2	53.9	40
45		81.1	82.4	81	82.5	84.1	83.1	80.2	76.8	74.6	70.4	58.1	61	53.7	52.4	45
50		69.9	71.1	69.9	72.2	72.8	71.8	70.4	68.7	65.9	62	55.1	58.4	51.8	50.4	50
55			62	60.8	63.8	63.7	62.6	63.5	61.1	58.7	55.8	52.1	52.5	49.7	48.7	55
60			55.2	53.4	56.4	56.2	56.2	56	54.8	52.7	49.7	48.5	46.6	45.4	44.9	60
65			49.2	47.4	50.3	50	50.6	49.7	49.2	47	44.3	43.6	41.7	40.6	40.1	65
70					45.2	44.9	45.4	44.7	43.7	42.3	39.8	39.2	37.3	36.5	36.1	70
75					40.8	41	40.8	40.1	39.1	38	35.9	35.5	33.6	33	32.5	75
80					37	36.9	36.8	36	35.2	34.1	32.5	32.2	30.4	29.8	29.4	80
85						33.5	33.4	32.7	31.8	30.7	29.5	29.3	27.5	27	26.6	85
90						30.6	30.5	29.7	28.8	27.8	26.6	26.7	25	24.6	24.2	90
95							27.8	27.1	26.3	25.3	24	24.2	22.7	22.4	22.1	95
100							25.6	24.9	24	23	21.8	22	20.6	20.5	20.2	100
105							23.6	22.9	22	21	19.8	20	18.6	18.6	18.3	105
110								21.1	20.2	19.2	18	18.2	16.8	16.8	16.6	110
115								19.5	18.6	17.6	16.4	16.6	15.2	15.2	15	115
120								18.1	17.1	16.1	14.9	15.1	13.7	13.8	13.5	120
125									15.9	14.8	13.6	13.8	12.4	12.4	12.2	125
130									14.7	13.6	12.4	12.6	11.2	11.2	11	130
135									13.7	12.5	11.3	11.4	10.1	10.1	9.9	135
140										11.5	10.3	10.4	9.1	9.1	8.9	140
145										10.7	9.4	9.5	8.2	8.2	8	145
150										10	8.6	8.7	7.4	7.4	7.2	150
155											7.8	7.9	6.7	6.7	6.6	155
160											7.2	7.2	6	6.1	5.9	160
165											6.7	6.7	5.3	5.5	5.3	165
170												6.1	4.7	4.8	4.6	170
175													4.1	4.2	4	175
180														3.6	3.4	180
185														3.1	2.9	185
190															2.5	190

t\_259\_101\_12010 / 32010\_00\_000

# Lifting capacities

## Forces de levage

T

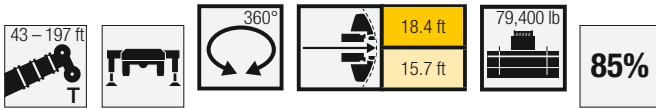

	43 ft	57 ft	71 ft	74 ft	85 ft	99 ft	114 ft	128 ft	142 ft	156 ft	170 ft	180 ft	184 ft	194 ft	197 ft	
10	295.4	266.6	265.2	265.1												10
11	295.4	267.7	266.1	266												11
12	295.4	268.9	267	266.9	258.5											12
13	290.9	270.2	268	267.2	260.1											13
14	278.9	271.7	268.4	264.1	261											14
15	266.9	266	265.7	260.7	262.1	226.6										15
16	255.7	256.1	255.9	252.9	254.3	243.9										16
17	245.3	245.7	245.7	242.3	245.4	237										17
18	235.2	235.4	235.5	231.8	235.2	229.1										18
19	225.4	226.9	226.5	224	225.6	219.5	202.5									19
20	216	217.5	217.9	214.6	217.3	211.4	199.8									20
22	198.2	200.1	201.9	196.7	202.1	194.5	181.4	154								22
24	180.3	182.4	184.8	178.8	184.5	174.5	162.1	148.3								24
26	163.9	167.5	168.8	162.3	167.4	156.8	146.8	139.1	122.5							26
28	147.5	151.4	153.3	146.9	151.4	142.3	134.3	126.8	119.2	90.7						28
30	132.4	136.2	138	134.1	137.9	130.1	123	119	111.8	99.9						30
32	119.9	123.8	125.2	121.5	125.7	119.5	116.3	110.9	105.1	97.2	75.3					32
34	109.3	113.1	114.5	110.9	114.8	110.7	108.3	102.9	97.5	92.3	79.2					34
36	100.3	103.9	105.3	101.7	105.4	102.4	100.8	95.8	90.9	86.1	78.2	62.4	64.3			36
38		96.1	97.4	93.8	97.6	97.8	94.2	89.6	84.9	81.9	76.2	61.7	63.8			38
40		89.1	90.5	88.7	90.7	92.5	88.4	84.3	81.3	78.4	74.2	60.8	63.1	55.2	53.9	40
45		75.1	76.5	75.2	78	78.2	75.8	73.7	70.9	68.3	64.7	58.1	60	53.7	52.4	45
50		64.3	66	64.3	67.5	67.4	66.1	65	62.3	60.1	56.6	54.6	53	51	50.2	50
55			57.5	55.7	58.8	58.7	59.2	57.1	55.4	52.9	49.6	48.6	46.4	45.2	44.6	55
60			50.4	49.2	51.8	51.5	51.7	50.8	49.2	46.8	43.9	43	41	40	39.4	60
65			44.2	44.5	45.6	45.8	45.4	44.7	43.6	41.6	39	38.4	36.5	35.5	35.1	65
70					40.4	40.7	40.4	39.6	38.6	37.3	34.9	34.4	32.6	31.8	31.4	70
75					36.1	36.3	36.1	35.4	34.4	33.3	31.3	31	29.2	28.6	28.2	75
80					32.7	32.7	32.5	31.7	30.8	29.8	28.2	28	26.2	25.7	25.3	80
85						29.5	29.3	28.6	27.7	26.7	25.4	25.3	23.6	23.2	22.8	85
90						26.8	26.7	25.9	25.1	24	22.8	22.9	21.3	20.9	20.6	90
95							24.3	23.6	22.7	21.7	20.5	20.7	19.2	19	18.6	95
100							22.3	21.5	20.6	19.6	18.4	18.6	17.2	17.2	16.9	100
105							20.5	19.6	18.8	17.8	16.6	16.8	15.4	15.4	15.2	105
110								18	17.2	16.1	15	15.2	13.8	13.8	13.6	110
115								16.6	15.7	14.7	13.5	13.7	12.3	12.4	12.1	115
120								15.4	14.4	13.4	12.2	12.4	11	11	10.8	120
125									13.2	12.2	11	11.2	9.8	9.8	9.6	125
130									12.2	11.1	9.9	10.1	8.7	8.8	8.5	130
135									11.4	10.1	8.9	9.1	7.7	7.8	7.6	135
140										9.2	8	8.1	6.9	7	6.8	140
145										8.4	7.3	7.4	6.2	6.2	6.1	145
150										7.8	6.6	6.7	5.5	5.6	5.4	150
155											6	6.1	4.8	4.9	4.7	155
160											5.3	5.4	4.1	4.2	4	160
165											4.8	4.8	3.4	3.6	3.4	165
170												4.2	2.9	3	2.8	170
175													2.3	2.4	2.2	175

t\_259\_101\_12013 / 32013\_00\_000



# Lifting capacities

## Forces de levage

T

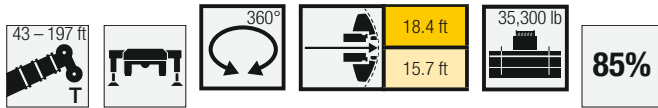

	43 ft	57 ft	71 ft	74 ft	85 ft	99 ft	114 ft	128 ft	142 ft	156 ft	170 ft	180 ft	184 ft	194 ft	197 ft	
10	295.4	266.6	265.2	265.1												10
11	295.4	267.7	266.1	266												11
12	294.8	268.9	267	266.9	258.5											12
13	285.6	270.2	268	267.2	260.1											13
14	272.1	268	265.7	264.1	257											14
15	258.8	258.8	259.1	256	249	220.9										15
16	246	246.6	246.1	238.9	226.7	209.4										16
17	233.3	234	227.7	217.9	208	194										17
18	220	221.8	210.6	197.8	195.5	178.3										18
19	206.8	207.4	196.6	186.1	180.7	165.4	152.2									19
20	193.7	195.1	181.3	171.7	167.6	153.9	143.9									20
22	166.6	167	156.4	148	145.7	136.4	129.2	120.3								22
24	143.3	145.4	137.8	131	128.6	123.8	115.1	107.9								24
26	125.1	128.2	122.1	118.4	117	110.6	102.9	98.7	92.5							26
28	110.5	114	108.9	105.6	105.5	99.4	94.8	89.9	84.5	78.7						28
30	98.6	101.6	98.5	94.7	95.3	90	86.4	81.9	77.3	72.9						30
32	88.5	91.5	89	85.5	86.6	82.8	79	75	70.9	66.9	62.7					32
34	78.2	82.9	81	78	79.1	76.2	72.6	69	65.4	61.6	57.7					34
36	69.5	74.5	74.2	73.5	72.6	69.9	67	63.8	60.4	57.1	53.5	52.5	49.9			36
38		67.2	68.2	68.2	67.1	64.8	62.2	59.2	56.1	53	49.7	48.8	46.2			38
40		60.8	62.9	62.9	62.2	60.2	57.9	55.1	52.2	49.4	46.2	45.3	42.8	41.2	40.5	40
45		48.5	50.8	51.1	51.9	50.6	48.8	46.7	44.1	41.7	39	38.2	36	34.7	34.1	45
50		39.6	42	42.3	43.1	43.1	41.9	39.9	37.9	35.7	33.2	32.5	30.4	29.4	28.9	50
55			35.1	35.5	36.4	36.5	36	34.6	32.8	30.9	28.5	27.9	26	25.2	24.7	55
60			29.8	30.2	31.1	31.2	30.9	30.1	28.5	26.8	24.7	24.1	22.3	21.6	21.2	60
65			25.7	25.9	26.9	26.9	26.6	25.9	24.9	23.4	21.3	21	19.2	18.6	18.2	65
70					23.4	23.4	23.2	22.5	21.6	20.4	18.5	18.3	16.6	16.1	15.8	70
75					20.6	20.5	20.3	19.6	18.7	17.7	16.1	16	14.3	13.9	13.6	75
80					18.3	18.1	17.8	17.1	16.3	15.3	14	13.9	12.2	12	11.6	80
85						16	15.7	15	14.2	13.2	11.9	12.1	10.5	10.3	9.9	85
90						14.2	13.9	13.2	12.4	11.4	10.1	10.4	8.9	8.7	8.4	90
95							12.3	11.6	10.8	9.8	8.6	8.8	7.5	7.4	7.1	95
100							11	10.2	9.4	8.4	7.3	7.5	6.2	6.2	5.9	100
105							9.8	9	8.2	7.3	6.3	6.4	5.1	5.1	4.8	105
110								7.9	7.2	6.3	5.3	5.5	4	4.1	3.7	110
115								7.1	6.3	5.5	4.5	4.7	2.8	2.9	2.5	115
120								6.4	5.6	4.7	3.7	3.9				120
125									4.8	3.9	2.6	3				125
130									4.1	3.1						130
135									3.5	2.2						135

t\_259\_101\_12018 / 32018\_00\_000

# Lifting capacities

## Forces de levage

T

43 – 197 ft  
360°  
18.4 ft  
15.7 ft  
24,300 lb  
85%

	43 ft	57 ft	71 ft	74 ft	85 ft	99 ft	114 ft	128 ft	142 ft	156 ft	170 ft	180 ft	184 ft	194 ft	197 ft	
10	295.4	266.6	265.2	265.1												10
11	295.4	267.7	266.1	266												11
12	294.7	268.9	267	266.9	258.5											12
13	284.9	270.2	268	267.2	260.1											13
14	270.8	267.3	264.8	264.1	251.2											14
15	257.2	257.5	254.6	243.3	227.8	203.9										15
16	244	244.1	229.3	219.7	207.8	192.1										16
17	228.9	229.1	212.1	201.2	195.1	176.7										17
18	214.4	210.5	195.6	184.9	178.3	163.8										18
19	199.9	194.3	179.3	169	164.7	152	142.6									19
20	184.9	177.7	165.2	155.9	152.6	143.3	133.3									20
22	155.6	151.8	142.3	137.3	132.8	126.6	116.5	108.4								22
24	133.6	131.8	124.7	120.8	119.3	111.3	104.2	98.1								24
26	116.5	115.2	109.4	105.6	105.3	98.7	94.1	88.5	82.8							26
28	102.8	101.2	97.8	93.6	94	89.4	84.7	79.9	75.1	69.7						28
30	90.2	89.9	87.5	85.4	84.8	80.8	76.8	72.6	68.4	64.3						30
32	78.2	80.8	78.9	78.8	76.9	73.6	70.1	66.4	62.6	58.9	54.9					32
34	68.5	73.1	71.6	71.6	70.1	67.5	64.3	60.9	57.6	54.1	50.5					34
36	60.6	65.6	65.4	65.4	64.2	61.9	59.2	56.2	53.1	50	46.7	45.8	43.3			36
38		59	60.1	60.1	59.2	57.2	54.8	52.1	49.2	46.4	43.2	42.5	40			38
40		53.3	55.4	55.4	54.8	53	51	48.4	45.7	43	40	39.3	37	35.5	34.8	40
45		42.2	44.4	44.7	45.5	44.3	42.7	40.8	38.4	36.1	33.5	32.9	30.7	29.6	29	45
50		34.2	36.5	36.8	37.6	37.6	36.5	34.7	32.8	30.6	28.3	27.8	25.8	24.9	24.4	50
55			30.4	30.7	31.5	31.6	31.2	29.8	28.1	26.3	24.1	23.6	21.7	21	20.6	55
60			25.6	25.9	26.8	26.9	26.6	25.8	24.3	22.6	20.6	20.2	18.4	17.8	17.4	60
65			21.8	22.1	23	23	22.7	22.1	21	19.5	17.6	17.4	15.6	15.1	14.8	65
70					19.9	19.9	19.6	18.9	18	16.9	15.1	15	13.2	12.9	12.5	70
75					17.3	17.2	17	16.3	15.5	14.4	12.9	12.9	11.2	10.9	10.5	75
80					15.3	15	14.8	14.1	13.3	12.3	10.9	11	9.3	9.1	8.8	80
85						13.1	12.9	12.2	11.4	10.4	9.1	9.3	7.7	7.6	7.2	85
90						11.6	11.2	10.5	9.7	8.7	7.6	7.8	6.3	6.2	5.9	90
95							9.8	9.1	8.3	7.4	6.4	6.5	5	5	4.7	95
100							8.6	7.9	7.1	6.3	5.3	5.5	3.6	3.7	3.3	100
105							7.6	6.9	6.2	5.4	4.2	4.4	2.3	2.3		105
110								6.1	5.4	4.5	3	3.4				110
115								5.3	4.6	3.7						115
120								4.6	3.8	2.6						120
125									3.1							125
130									2.3							130

t\_259\_101\_12019 / 32019\_00\_000

# Lifting capacities

## Forces de levage

T

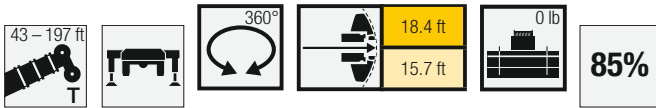

	43 ft	57 ft	71 ft	74 ft	85 ft	99 ft	114 ft	128 ft	142 ft	156 ft	170 ft	180 ft	184 ft	194 ft	197 ft	
10	295.4	266.6	265.2	265.1												10
11	295.4	267.7	266.1	266												11
12	293.7	268.9	267	258.1	240.4											12
13	277.9	268.4	244	236.8	222											13
14	261.2	247.6	217.9	210.2	198.2											14
15	241.4	217.3	198.4	185.9	176	148										15
16	217.2	196.3	176.4	167	159	146										16
17	191	174.7	159	153.4	146	132.7										17
18	169.8	157	143.2	137.8	132.6	120.3										18
19	151.5	141.7	130	123.9	120.9	110.9	102.1									19
20	135.3	126.9	118.5	113.1	110.6	102.3	94.4									20
22	109.3	105.1	99.3	98.6	93.9	87.8	81.7	74.9								22
24	91	88.9	85.5	84.6	81.2	76.5	71.6	66.7								24
26	77.2	76.4	74.1	73.6	71.2	67.3	63.4	59.2	54.8							26
28	66.4	66.5	65.1	64.9	63	59.9	56.6	53	49.2	44.9						28
30	57.8	58.4	57.7	57.7	56.4	53.8	50.9	47.8	44.5	41.2						30
32	49.4	52	51.5	51.6	50.8	48.5	46.1	43.3	40.3	37.3	34.1					32
34	42.6	46.4	46.3	46.5	45.9	44.2	41.9	39.4	36.7	33.9	30.9					34
36	37	41.7	41.9	42.1	41.6	40.1	38.3	36	33.5	31	28.2	27.7	25.5			36
38		37.2	38.1	38.2	38	36.8	35.1	33	30.7	28.4	25.7	25.4	23.2			38
40		33.1	34.7	34.9	34.9	33.8	32.3	30.3	28.2	26	23.4	23.2	21	20.2	19.6	40
45		25.3	27.4	27.7	28.4	27.5	26.4	24.9	22.9	21	18.8	18.7	16.6	16	15.6	45
50		19.7	21.7	22	23	22.8	21.9	20.5	18.9	17.1	15	15.1	13.1	12.7	12.2	50
55			17.4	17.7	18.6	18.7	18.2	17	15.5	14	12	12.1	10.2	9.9	9.6	55
60			14.1	14.3	15.2	15.3	15.1	14.2	12.8	11.3	9.5	9.6	7.8	7.7	7.3	60
65			11.5	11.7	12.5	12.6	12.3	11.7	10.4	9.1	7.4	7.6	5.6	5.7	5.2	65
70					10.3	10.3	10.1	9.5	8.5	7.2	5.4	5.7	3.5	3.4	3.1	70
75					8.5	8.5	8.2	7.6	6.9	5.6	3.5	3.8				75
80					7.3	7	6.8	6.3	5.4	3.8						80
85						5.9	5.7	5.1	3.9	2.3						85
90						4.8	4.7	3.9	2.4							90
95							3.5	2.6								95
100							2.4									100

L\_259\_101\_12021 / 32021\_00\_000

# Lifting heights Hauteurs de levage

T

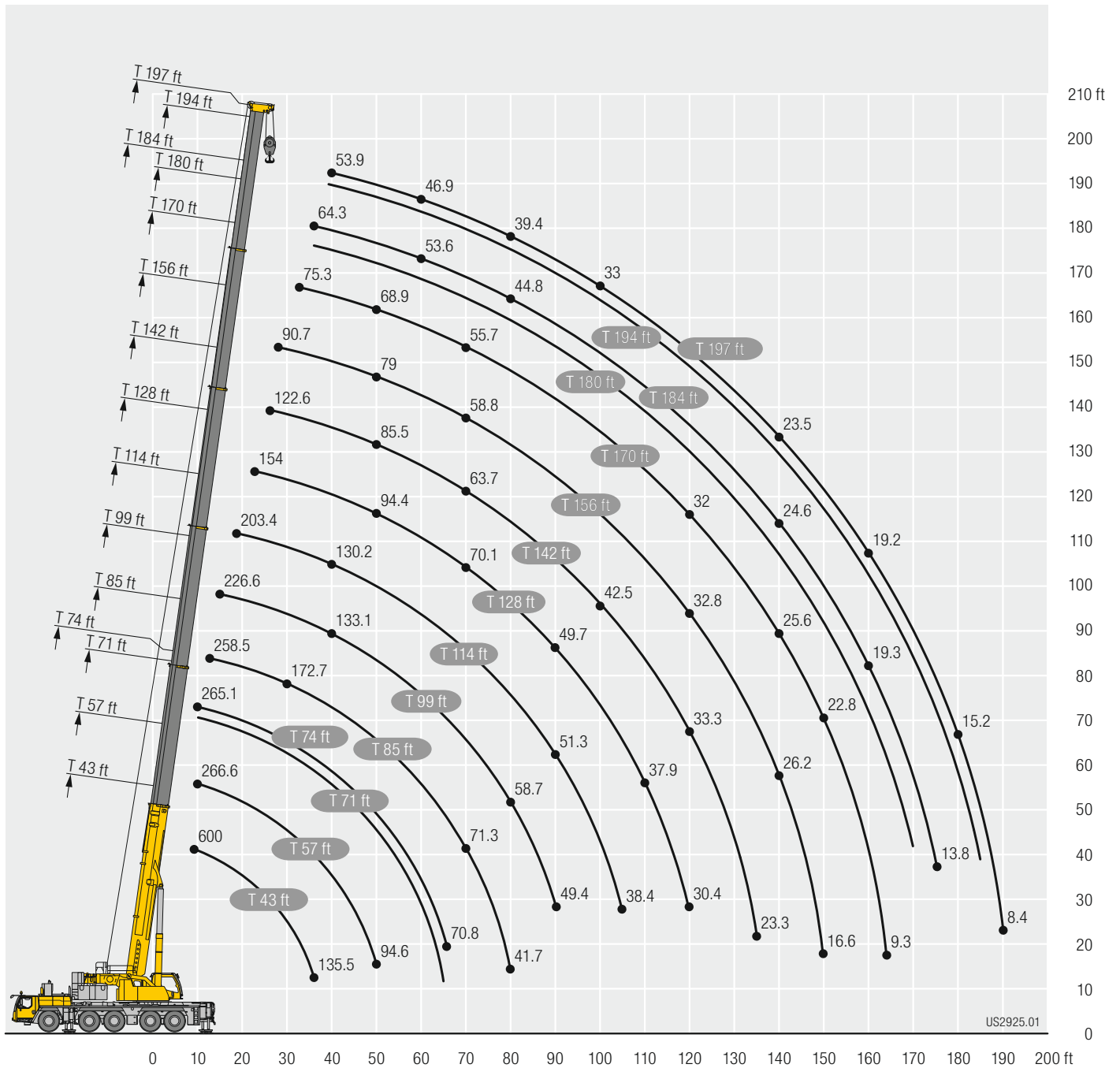

# Lifting capacities Forces de levage

**TNZK**



Lifting height (ft)	43 ft			99 ft			114 ft			128 ft			142 ft			156 ft			Lifting height (ft)
	0°	22,5°	45°	0°	22,5°	45°	0°	22,5°	45°	0°	22,5°	45°	0°	22,5°	45°	0°	22,5°	45°	
10	127.9																		10
11	127.9																		11
12	127.9	96.2																	12
13	127.2	93.4																	13
14	123.9	91.4																	14
15	120.6	89.8																	15
16	117.3	88.1	75																16
17	114	86.4	74.7																17
18	111.2	84.7	73.6	118.4															18
19	108.4	82.9	72.4	117.1															19
20	105.5	81.2	71.2	115.9			111.4												20
22	98.9	78.2	69.1	113.3	88.7		109.9												22
24	94.4	75.9	67.3	110.9	87.2		108.1			99.3									24
26	90.8	73.4	66	108.5	85.7	73.3	106.3	85.8		98.6									26
28	86	70.9	64.6	106.1	84.3	72.4	104.5	84.5		97.4			86.7						28
30	82.4	68.8	63.4	103.9	82.9	71.5	102.7	83.3	72.2	96.2	81.2		86.3						30
32	79	67	61.9	101.8	81.5	70.8	101	82.1	71.5	95.1	80.3	70.8	85.8			74.1			32
34	76.4	65.3	60.5	99.8	80.2	70.1	99.4	80.9	70.8	93.9	79.3	70.2	85.2	75.9		74			34
36	74.1	63.4	59.1	97.9	79	69.4	97.8	79.9	70.1	92.8	78.4	69.6	84.6	75.2		73.8			36
38	71.1	61.1	57.7	95.9	77.9	68.7	96.1	78.8	69.4	91.7	77.4	69	83.9	74.5	68.1	73.4	68.7		38
40	68	58.8	56.2	94	76.7	67.9	94.4	77.7	68.8	90.4	76.5	68.4	83.2	73.8	67.6	72.6	68.4		40
45	60.4	53.9	53.5	89.4	74	66.2	90.4	75.2	67.4	87.3	74.2	67.1	80.9	72	66.4	69.7	67.2	63.3	45
50	54.1	50.9	13.1	85.2	71.6	64.6	86.7	72.9	66.1	82.6	72.1	65.9	75.9	70.2	65.2	66.5	65.2	62.4	50
55	46.1			81.7	69.5	63.1	83.3	70.8	64.6	76.4	70.3	64.8	70.8	68.6	64.2	63	61.8	60.9	55
60				78.1	67.2	61.4	80.3	69	63.4	70.5	68.1	63.6	65.7	65.4	63.2	59.5	58.4	57.9	60
65				74.6	65.2	59.7	75.8	67.4	61.9	65.2	64.5	62.2	61	61.1	60.5	56.1	55.4	54.9	65
70				70.1	62.9	58.1	68.7	65.8	60.4	60.6	60.5	60.1	56.7	56.9	57	52.8	52.5	52.1	70
75				63.8	60	56.5	62.4	63.1	59	56.1	56.4	56.7	52.9	53	53.4	49.5	49.7	49.6	75
80				58.4	57.5	55.2	57	57.6	57.4	52.5	52.6	52.8	49.4	49.6	49.9	46.4	46.7	46.9	80
85				53.7	54.1	54	52.3	52.8	53.1	49	49.2	49.5	46.2	46.5	46.8	43.7	43.9	44.2	85
90				49.6	50	39.8	48.2	48.7	48.9	46	46	46.3	43.4	43.6	43.9	41	41.4	41.7	90
95				46	46.3	19.7	44.6	44.9	45.1	43.1	43.3	43.5	40.7	41	41.2	38.5	38.9	39.2	95
100				42.8	43	12.6	41.3	41.6	41.7	39.7	40.2	40.4	38.7	38.5	38.7	36.4	36.6	36.9	100
105				39.7	40		38.3	38.6	23	36.7	37.1	37.2	36.8	36.6	36.6	34.3	34.6	34.8	105
110				30.1			35.6	35.8	14.9	34	34.3	34.4	34.8	34.9	35	32.4	32.6	32.8	110
115							33.1	33.3		31.5	31.8	26.3	32.5	32.8	33	30.6	30.9	31	115
120							30.1			29.3	29.5	17.4	30.2	30.5	30.6	28.8	29.1	29.3	120
125							20.2			27.3	27.5	12.6	28.2	28.5	28.5	27.5	27.4	27.6	125
130										25.4	25.6		26.3	26.5	19.7	26.4	26.3	26.5	130
135										21.9			24.6	24.8	14.1	24.9	25.1	25.2	135
140										14.8			23	23.2		23.3	23.5	22	140
145													21.6			21.8	22	16.1	145
150													18.9			20.5	20.6	12.5	150
155																19.2	19.4		155
160																17.9			160
165																15.2			165

t\_259\_106\_10151 / 30151\_00\_000



# Lifting capacities Forces de levage

**TNZK**

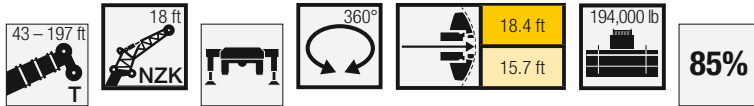

Lifting Capacity (lb)	170 ft			180 ft			184 ft 18 ft			194 ft			197 ft			Lifting Capacity (lb)
	0°	22,5°	45°	0°	22,5°	45°	0°	22,5°	45°	0°	22,5°	45°	0°	22,5°	45°	
36	60.7															36
38	60.3			47.6												38
40	59.6			47.3			49.5									40
45	57.7	56.7		46.1	45.2		48.2			40.9			40			45
50	55.6	54.5	54.1	44.8	43.7	43.4	46.7	46.2	45.7	40.2	39.8		39.4	39		50
55	53.4	52.1	51.8	43.1	42.1	41.7	45.2	44.5	44.3	39.4	38.9	38.9	38.7	38.2	38.4	55
60	51	49.8	49.5	41.2	40.3	39.9	43.5	42.8	42.6	38.3	37.9	37.8	37.7	37.3	37.3	60
65	48.8	47.6	47.3	39.3	38.4	38.1	41.7	41	40.9	37	36.7	36.5	36.5	36.2	36.2	65
70	46.6	45.6	45.3	37.4	36.7	36.4	40	39.4	39.3	35.8	35.3	35.2	35.3	35	34.9	70
75	44.5	43.7	43.4	35.6	35.1	34.9	38.4	37.8	37.7	34.4	34	33.8	34.1	33.7	33.6	75
80	42.5	41.8	41.6	33.9	33.5	33.4	36.9	36.3	36.2	33.1	32.7	32.6	32.8	32.4	32.4	80
85	40.6	40	39.9	32.2	31.9	31.9	35.4	34.9	34.8	31.7	31.4	31.4	31.5	31.2	31.2	85
90	38.7	38.2	38.2	30.7	30.4	30.4	34	33.5	33.5	30.3	30.1	30.1	30.2	29.9	30	90
95	36.8	36.5	36.5	29.2	29	29.1	32.6	32.2	32.2	29.1	28.8	28.9	29	28.7	28.8	95
100	34.9	34.9	34.9	27.9	27.7	27.8	31.4	31	31	27.9	27.7	27.7	27.8	27.6	27.7	100
105	33.1	33.2	33.3	26.6	26.5	26.6	30.2	29.9	29.9	26.7	26.6	26.6	26.7	26.5	26.6	105
110	31.4	31.6	31.8	25.4	25.3	25.4	29.1	28.8	28.9	25.7	25.5	25.6	25.7	25.5	25.6	110
115	29.7	30	30.2	24.3	24.2	24.3	27.9	27.8	27.9	24.7	24.6	24.6	24.7	24.5	24.6	115
120	28.1	28.4	28.6	23.3	23.2	23.3	26.9	26.8	26.9	23.7	23.6	23.7	23.7	23.6	23.7	120
125	26.7	26.9	27.1	22.3	22.3	22.3	25.8	25.8	25.9	22.8	22.7	22.8	22.8	22.7	22.8	125
130	25.4	25.6	25.7	21.4	21.4	21.4	24.7	24.8	25	22	21.9	22	21.9	21.9	22	130
135	23.9	24.2	24.3	20.5	20.5	20.6	23.5	23.7	23.9	21.1	21.1	21.2	20.9	21	21.2	135
140	22.4	22.6	22.6	19.7	19.7	19.8	22.4	22.6	22.8	20.4	20.3	20.4	20.1	20.2	20.4	140
145	21.6	21.6	21.7	18.9	18.9	19	21.3	21.5	21.7	19.6	19.6	19.7	19.3	19.4	19.6	145
150	20.8	20.8	20.9	18.1	18.1	18.2	20.1	20.3	20.4	18.9	18.9	19.1	18.5	18.6	18.8	150
155	19.9	20	17.8	17.4	17.4	17.5	18.8	19	19.1	18.2	18.3	18.4	17.7	17.8	18	155
160	18.7	18.9	13.6	16.7	16.7	16.8	17.6	17.8	17.8	17.6	17.6	17.7	17	17.2	17.3	160
165	17.6	17.7		16	16.1	15.9	16.5	16.6	16.6	16.7	16.8	16.9	16.3	16.5	16.5	165
170	16.6	16.7		15.5	15.5	12.9	15.4	15.6	15.3	15.7	15.8	15.9	15.5	15.7	15.7	170
175	15			14.9	14.9		14.5	14.6	12.5	14.7	14.8	14.8	14.5	14.7	14.7	175
180	10.5			14.4	14.4		13.5	13.6		13.7	13.9	13.6	13.6	13.7	13.7	180
185				13			12.7			12.9	13		12.7	12.8	12.7	185
190				8.7			10.6			12	12.1		11.9	12		190
195							6.2			11.3			11.1	11.2		195
200										9			9.9			200
205										5.1			6.8			205

t\_259\_106\_10151 / 30151\_00\_000

# Lifting capacities Forces de levage

**TNZK**

43 ft	99 ft			114 ft			128 ft			142 ft			156 ft			40 ft	
	0°	22,5°	45°	0°	22,5°	45°	0°	22,5°	45°	0°	22,5°	45°	0°	22,5°	45°		
10	46.1															10	
11	46.1															11	
12	46.1															12	
13	46.1															13	
14	46.1															14	
15	46.1															15	
16	46.1															16	
17	46.1			46.1												17	
18	46.1			46.1												18	
19	46.1			46.1			46.1									19	
20	46.1			46.1			46.1									20	
22	46.1	45.8		46.1			46.1			46.1						22	
24	46.1	44.5		46.1			46.1			46.1						24	
26	46.1	42.6		46.1			46.1			46.1			46.1			26	
28	46.1	40.8		46.1			46.1			46.1			46.1			28	
30	46.1	39.1		46.1			46.1			46.1			46.1			30	
32	45.8	37.6		46.1	45.7		46.1			46.1			46.1		45.7	32	
34	44.5	36.2	27.9	46.1	44.8		46.1			46.1			46.1		45.5	34	
36	43.1	35	27.3	46.1	43.7		46.1	44.1		46.1			46.1		45.3	36	
38	41.8	33.8	26.7	46.1	42.6		46.1	43.3		46.1			46.1		45	38	
40	40.4	32.7	26.2	46.1	41.5		46.1	42.4		46.1	41.8		46.1		44.6	40	
45	36.9	30.3	25	46.1	39	27.8	46.1	40.1	28	46.1	40.2		46.1	39	43.7	45	
50	33.1	28.3	24	46.1	36.9	26.9	46.1	38	27.2	46.1	38.5	27.3	46.1	37.7	42.7	50	
55	29.8	26.5	23.4	46	35.1	26.2	45.8	36.2	26.5	45.7	36.7	26.6	45.2	36.4	26.7	41.6	55
60	27	24.9	22.9	44.6	33.3	25.5	45.2	34.5	25.8	44.9	35.2	26	43.6	34.9	26.1	40.5	60
65	24.6	23.5	22.7	42.6	31.9	24.9	43.9	33	25.2	43.7	33.7	25.5	42.1	33.6	25.5	39.3	65
70	22.7	22.3	15.3	40.6	30.6	24.4	42	31.7	24.8	41.9	32.5	24.9	40.6	32.3	25.1	38.3	70
75	21	21.6		38.5	29.3	23.9	40	30.5	24.3	40.2	31.2	24.5	39.3	31.2	24.6	37.2	75
80				36.4	28.2	23.6	38.2	29.5	23.9	38.7	30.1	24.1	38	30.1	24.3	36.2	80
85				34.1	27.3	23.3	36.5	28.4	23.6	37.2	29	23.8	36.8	29.1	23.9	35.2	85
90				32	26.3	23	34.7	27.4	23.3	35.7	28.1	23.5	35.6	28.2	23.6	34.2	90
95				30.1	25.4	22.9	32.9	26.5	23.1	34.2	27.1	23.2	34.4	27.3	23.4	33.2	95
100				28.3	24.6	22.8	31.2	25.6	22.9	32.7	26.3	23	33.1	26.5	23.1	32.2	100
105				26.7	23.8	22.7	29.6	24.8	22.8	31.3	25.5	22.8	31.8	25.8	23	31.2	105
110				25.3	23.1	22.6	28.1	24.1	22.6	29.9	24.8	22.7	30.6	25.1	22.8	30.2	110
115				24.1	22.5	17.4	26.7	23.5	22.5	28.7	24.1	22.5	29.5	24.4	22.5	29.1	115
120				22.9	22		25.4	22.9	22.4	27.5	23.5	22.4	28.3	23.8	22.3	28	120
125				21.9	21.7		24.3	22.3	19.2	26.4	22.9	22.2	27.3	23.3	22.1	26.8	125
130				20.9			23.2	21.9	16.9	25.2	22.4	22.2	26.2	22.8	22	25.5	130
135							22.3	21.5		24.2	22	20.1	25.2	22.3	21.9	24.2	135
140							21.4	21.4		23.3	21.6	14.5	24.1	21.9	21.9	22.8	140
145							19.5			22.1	21.3	14	22.6	21.6	21.7	21.3	145
150										20.7	21.1		21.2	21.2	17.7	20.2	150
155										18.6			19.9	20.5	16.6	19.5	155
160										14.1			18.8	19.2	15.1	18.8	160
165													17.7	18		17.8	165
170													15.1	16.7		16.7	170
175													12.3			15.8	175
180																14.8	180
185																13.3	185
190																7.7	190

t\_259\_106\_11151 / 31151\_00\_000

# Lifting capacities Forces de levage

**TNZK**



↙ ↘	170 ft			180 ft			184 ft 40 ft			194 ft			197 ft			↙ ↘
	0°	22,5°	45°	0°	22,5°	45°	0°	22,5°	45°	0°	22,5°	45°	0°	22,5°	45°	
36	39.4															36
38	39.2			33.2												38
40	39			33.1			33.4									40
45	38.4			32.7			33			29.8			29.2			45
50	37.8			32.4			32.7			29.5			28.9			50
55	37.2	32.5		32.1			32.4			29.3			28.7			55
60	36.5	31.6		31.7	28.6		32	28.9		29.1	27		28.5			60
65	35.7	30.6	25.2	31.2	27.9		31.6	28.2		28.8	26.5		28.3	26.2		65
70	34.9	29.8	24.8	30.6	27.3	24	31.1	27.6	24.2	28.5	26		28	25.7		70
75	34.2	28.9	24.4	29.7	26.7	23.6	30.6	27	23.8	28.1	25.5	23	27.7	25.3	22.9	75
80	33.5	28.2	24	28.7	26.1	23.3	30.1	26.4	23.4	27.4	25	22.7	27.1	24.8	22.5	80
85	32.7	27.4	23.8	27.6	25.5	22.9	29.2	25.8	23.1	26.7	24.6	22.4	26.4	24.3	22.3	85
90	31.9	26.8	23.5	26.4	24.8	22.6	28.3	25.2	22.7	25.8	24.1	22.1	25.6	23.9	22	90
95	31.1	26.1	23.2	25.4	24.1	22.3	27.3	24.7	22.4	24.9	23.6	21.8	24.8	23.5	21.7	95
100	30.2	25.5	22.8	24.4	23.3	22	26.4	24.2	22.1	24.1	23.1	21.6	23.9	22.9	21.5	100
105	29.2	24.9	22.5	23.4	22.5	21.6	25.4	23.7	21.9	23.2	22.4	21.3	23.1	22.3	21.2	105
110	28.1	24.4	22.3	22.5	21.8	21.2	24.5	23.2	21.6	22.4	21.7	21	22.3	21.6	20.9	110
115	27.1	23.9	22	21.6	21	20.7	23.7	22.6	21.4	21.6	21	20.6	21.5	20.9	20.5	115
120	26.1	23.4	21.8	20.6	20.3	20.2	22.9	22	21.2	20.8	20.3	20.1	20.7	20.3	20.1	120
125	25.1	22.9	21.6	19.8	19.6	19.6	22.1	21.5	21	20	19.7	19.6	20	19.7	19.6	125
130	24.2	22.5	21.5	19	18.9	19	21.4	20.9	20.6	19.3	19	19	19.2	19	19	130
135	23.2	22.1	21.4	18.2	18.2	18.4	20.7	20.3	20.1	18.5	18.4	18.5	18.5	18.4	18.5	135
140	22.1	21.7	21.3	17.5	17.5	17.7	20	19.7	19.7	17.9	17.8	17.9	17.9	17.8	17.9	140
145	21.1	21.1	21.1	16.9	16.9	17.1	19.4	19.1	19.2	17.2	17.1	17.4	17.3	17.2	17.4	145
150	20.1	20.4	20.5	16.2	16.2	16.5	18.8	18.5	18.7	16.6	16.6	16.8	16.6	16.6	16.8	150
155	18.9	19.6	19.9	15.6	15.6	15.9	18.2	18	18.2	16	16	16.2	16	16	16.3	155
160	17.7	18.4	18.8	15	15.1	15.3	17.5	17.5	17.7	15.5	15.5	15.7	15.5	15.5	15.7	160
165	16.6	17.3	17.6	14.5	14.5	14.8	16.8	17	17.2	15	15	15.2	14.9	15	15.2	165
170	16	16.1	16.4	13.9	14	14.3	16	16.4	16.7	14.5	14.5	14.7	14.4	14.5	14.8	170
175	15.5	15.6	12.5	13.5	13.5	13.8	15	15.6	15.9	14	14	14.2	13.8	14	14.3	175
180	15	15.1	12	13	13.1	13.1	14.1	14.6	14.9	13.5	13.6	13.8	13.3	13.6	13.8	180
185	14.3	14.6	11.5	12.5	12.7	8.8	13.2	13.7	10.8	13.1	13.1	13.4	12.8	13.1	13.3	185
190	13.5	13.9		12.1	12.2	7.7	12.4	12.8	9.8	12.3	12.7	12.9	12.1	12.6	12.8	190
195	12.5			11.6	11.8	7	11.6	12	9.1	11.6	12	10.6	11.4	11.9	12	195
200	9.4			11.3	11.4		10.9	11.2	8.3	10.8	11.3	8	10.7	11.1	8.4	200
205	3.5			10.7	11		10.2	10.5	7.3	10.2	10.5	7.3	10	10.4	7.5	205
210				7.9			8.7	9.6		9.5	9.8		9.3	9.7	6.5	210
215							6			8.9	9.2		8.7	9		215
220										7.3			7.8	8.3		220
225										4.9			5.8			225
230													2.5			230

t\_259\_106\_11151 / 31151\_00\_000

# Lifting capacities

## Forces de levage

**TNZK**



Lifting height (ft)	43 ft			99 ft			114 ft			128 ft			142 ft			156 ft			Lifting height (ft)
	0°	22,5°	45°	0°	22,5°	45°	0°	22,5°	45°	0°	22,5°	45°	0°	22,5°	45°	0°	22,5°	45°	
13	23.3																		13
14	23.3																		14
15	23.3																		15
16	23.3																		16
17	23.3																		17
18	23.2																		18
19	23.1																		19
20	23																		20
22	22.7			23.2															22
24	22.3			23.2															24
26	21.9			23.2			22.6												26
28	21.5			23.2			22.6			20.2									28
30	21			23.1			22.6			20.2			19.5						30
32	20.6			23			22.6			20.2			19.5						32
34	20.1			22.8			22.6			20.2			19.5			18.4			34
36	19.7			22.6			22.4			20.2			19.5			18.4			36
38	19.2			22.3			22.1			20.2			19.5			18.4			38
40	18.8	15.7		22			21.9			20.1			19.4			18.4			40
45	17.5	14.8		21.4			21.3			19.8			19.2			18.3			45
50	16.4	13.9		20.6	15.7		20.6			19.4			18.9			18.1			50
55	15.4	13.2		19.9	15.1		20	15.1		18.9			18.5			17.8			55
60	14.5	12.5	10.9	19.1	14.5		19.3	14.6		18.5	15.1		18.1	14.9		17.5			60
65	13.6	11.9	10.5	18.3	13.9		18.6	14.1		18	14.6		17.7	14.5		17.1	14.2		65
70	12.9	11.4	10.2	17.4	13.5	10.9	17.9	13.6		17.6	14.2		17.3	14.1		16.8	13.9		70
75	12.2	11	9.9	16.7	13	10.7	17.2	13.2	10.7	17.1	13.8	11.2	16.9	13.7		16.4	13.5		75
80	11.6	10.5	9.7	16	12.6	10.4	16.5	12.8	10.5	16.6	13.4	11	16.5	13.4	10.9	16.1	13.2		80
85	10.9	10.2	9.6	15.3	12.2	10.3	15.9	12.4	10.3	16.2	13	10.8	16.1	13	10.7	15.7	12.9	10.6	85
90	10.2	9.9	9.5	14.7	11.8	10.1	15.2	12.1	10.1	15.7	12.7	10.6	15.7	12.7	10.5	15.4	12.6	10.5	90
95	9.6	9.7	9.5	14.1	11.5	9.9	14.7	11.7	10	15.3	12.4	10.4	15.3	12.4	10.4	15.1	12.3	10.3	95
100	9.1	9.5	9.5	13.6	11.2	9.8	14.1	11.4	9.8	14.8	12.1	10.3	14.9	12.1	10.3	14.7	12	10.2	100
105	8.6	9.1		13.1	10.9	9.7	13.6	11.1	9.7	14.4	11.8	10.2	14.5	11.9	10.1	14.4	11.8	10.1	105
110				12.6	10.7	9.6	13.1	10.9	9.6	13.9	11.5	10	14.1	11.6	10	14	11.6	10	110
115				12.2	10.4	9.6	12.7	10.7	9.5	13.5	11.3	10	13.7	11.4	9.9	13.7	11.3	9.9	115
120				11.7	10.2	9.5	12.3	10.4	9.5	13.1	11.1	9.9	13.3	11.2	9.9	13.3	11.1	9.8	120
125				11.3	10	9.5	11.9	10.2	9.4	12.7	10.9	9.8	12.9	11	9.8	13	10.9	9.7	125
130				10.9	9.9	9.5	11.5	10.1	9.4	12.3	10.7	9.8	12.6	10.8	9.7	12.7	10.8	9.7	130
135				10.4	9.7	9.5	11.2	9.9	9.4	12	10.5	9.7	12.3	10.6	9.7	12.4	10.6	9.6	135
140				9.9	9.6	9.5	10.8	9.7	9.4	11.7	10.3	9.7	12	10.4	9.7	12.1	10.4	9.6	140
145				9.6	9.5	9.5	10.4	9.6	9.4	11.4	10.2	9.7	11.7	10.3	9.7	11.8	10.3	9.6	145
150				9.2	9.5	9.5	10	9.5	9.4	11.1	10.1	9.7	11.4	10.1	9.7	11.5	10.2	9.6	150
155				8.9	9.5	9.2	9.7	9.5	9.4	10.9	9.9	9.7	11.1	10	9.7	11.3	10	9.6	155
160				8.6	9.5		9.3	9.4	9.4	10.6	9.9	9.7	10.9	9.9	9.7	11	9.9	9.6	160
165				8.4			9	9.4	9.4	10.4	9.8	9.7	10.7	9.8	9.7	10.8	9.8	9.6	165
170							8.7	9.4		10.1	9.8	9.7	10.4	9.8	9.7	10.6	9.7	9.6	170
175							8.5	9.4		9.9	9.7	9.7	10.2	9.7	9.7	10.4	9.7	9.6	175
180							8.3			9.6	9.7	9.7	10.1	9.7	9.7	10.2	9.6	9.6	180
185										9.3	9.7		9.8	9.7	9.7	10.1	9.6	9.6	185
190										9.1	9.7		9.6	9.7	9.6	9.9	9.6	9.6	190
195													9.4	9.7		9.8	9.6	9.6	195
200													9.2	9.7		9.6	9.6	9.6	200
205													8.9			9.4	9.6	9.6	205
210																9.2	9.6		210
215																9			215
220																7.3			220

t\_259\_106\_13151 / 33151\_00\_000

# Lifting capacities Forces de levage

**TNZK**



Lifting height (ft)	170 ft			180 ft			184 ft 72 ft			194 ft			197 ft			Lifting height (ft)
	0°	22,5°	45°	0°	22,5°	45°	0°	22,5°	45°	0°	22,5°	45°	0°	22,5°	45°	
38	17															38
40	17			15.3												40
45	17			15.3			15.4			14.3			14.1			45
50	16.9			15.2			15.4			14.3			14.1			50
55	16.8			15.2			15.3			14.3			14.1			55
60	16.6			15.2			15.3			14.3			14.1			60
65	16.3			15			15.2			14.2			14			65
70	16	13.5		14.8			15			14.2			14			70
75	15.7	13.2		14.6	12.6		14.7	12.7		14			13.9			75
80	15.4	12.9		14.4	12.3		14.5	12.4		13.8	12		13.7	12		80
85	15.1	12.6		14.1	12.1		14.3	12.2		13.6	11.8		13.5	11.8		85
90	14.9	12.4	10.3	13.9	11.8		14	11.9		13.4	11.6		13.3	11.6		90
95	14.6	12.1	10.2	13.7	11.6	10	13.8	11.7	10	13.3	11.4	9.9	13.2	11.4		95
100	14.3	11.8	10.1	13.5	11.4	9.9	13.6	11.5	9.9	13.1	11.2	9.8	13	11.2	9.7	100
105	14	11.6	10	13.2	11.2	9.8	13.3	11.3	9.8	12.9	11	9.7	12.8	11	9.7	105
110	13.7	11.4	9.9	13	11	9.7	13.1	11.1	9.7	12.7	10.8	9.6	12.6	10.8	9.6	110
115	13.4	11.2	9.8	12.7	10.9	9.6	12.8	10.9	9.7	12.5	10.7	9.5	12.4	10.7	9.5	115
120	13.1	11	9.7	12.5	10.7	9.6	12.6	10.8	9.6	12.2	10.5	9.5	12.2	10.5	9.5	120
125	12.8	10.8	9.6	12.2	10.5	9.5	12.4	10.6	9.5	12	10.4	9.4	12	10.4	9.4	125
130	12.5	10.7	9.6	12	10.4	9.5	12.1	10.5	9.5	11.8	10.3	9.4	11.8	10.2	9.4	130
135	12.2	10.5	9.6	11.8	10.2	9.4	11.9	10.3	9.4	11.6	10.1	9.3	11.6	10.1	9.3	135
140	12	10.4	9.5	11.5	10.1	9.4	11.7	10.2	9.4	11.4	10	9.3	11.4	10	9.3	140
145	11.7	10.2	9.5	11.3	10	9.4	11.5	10.1	9.4	11.2	9.9	9.3	11.2	9.9	9.3	145
150	11.5	10.1	9.5	11.1	9.9	9.4	11.3	9.9	9.3	11	9.8	9.3	11	9.8	9.3	150
155	11.3	10	9.5	10.9	9.8	9.4	11.1	9.8	9.3	10.9	9.7	9.3	10.8	9.7	9.3	155
160	11.1	9.9	9.5	10.8	9.7	9.4	10.9	9.7	9.3	10.7	9.6	9.3	10.7	9.6	9.3	160
165	10.8	9.8	9.5	10.6	9.6	9.4	10.7	9.7	9.3	10.5	9.5	9.3	10.5	9.5	9.3	165
170	10.6	9.7	9.5	10.4	9.5	9.4	10.5	9.6	9.3	10.4	9.5	9.3	10.4	9.5	9.3	170
175	10.5	9.6	9.5	10.3	9.5	9.4	10.4	9.5	9.3	10.2	9.4	9.3	10.2	9.4	9.3	175
180	10.3	9.6	9.5	10.1	9.4	9.4	10.2	9.5	9.3	10.1	9.4	9.3	10.1	9.3	9.3	180
185	10.1	9.5	9.5	10	9.4	9.4	10.1	9.4	9.3	9.9	9.3	9.3	10	9.3	9.3	185
190	10	9.5	9.5	9.8	9.4	9.4	9.9	9.4	9.3	9.8	9.3	9.3	9.8	9.2	9.3	190
195	9.8	9.5	9.5	9.7	9.3	9.4	9.8	9.3	9.3	9.7	9.3	9.3	9.7	9.2	9.3	195
200	9.7	9.5	9.5	9.5	9.3	9.4	9.7	9.3	9.3	9.6	9.2	9.3	9.6	9.2	9.3	200
205	9.6	9.5	9.5	9.4	9.3	9.4	9.6	9.3	9.3	9.5	9.2	9.3	9.5	9.2	9.3	205
210	9.5	9.5	9.5	9.1	9.2	9.4	9.5	9.3	9.3	9.3	9.2	9.3	9.4	9.2	9.3	210
215	9.3	9.5	9.5	8.8	9	9.3	9.4	9.3	9.3	9.1	9.2	9.3	9.1	9.1	9.3	215
220	9.1	9.5	9	8.5	8.8	9.1	9.2	9.3	9.3	8.9	9.1	9.3	8.8	9.1	9.3	220
225	9	9.5		8.3	8.5	8.8	8.7	9.2	9.2	8.5	8.8	9.2	8.4	8.9	9.2	225
230	7.5			8.1	8.3		8.1	8.6	8.5	8	8.6	8.7	7.9	8.5	8.6	230
235	4.6			7.8	8		7.6	8		7.5	8.1	8	7.4	7.9	7.9	235
240				6.4			6.6	7.5		7.1	7.5	7.4	7	7.4		240
245				3.6			4.8			6.7	7		6.6	6.9		245
250										5.6	6.6		5.9	6.5		250
255										3.9			4.5			255

t\_259\_106\_13151 / 33151\_00\_000



# Lifting heights Hauteurs de levage

TNZK

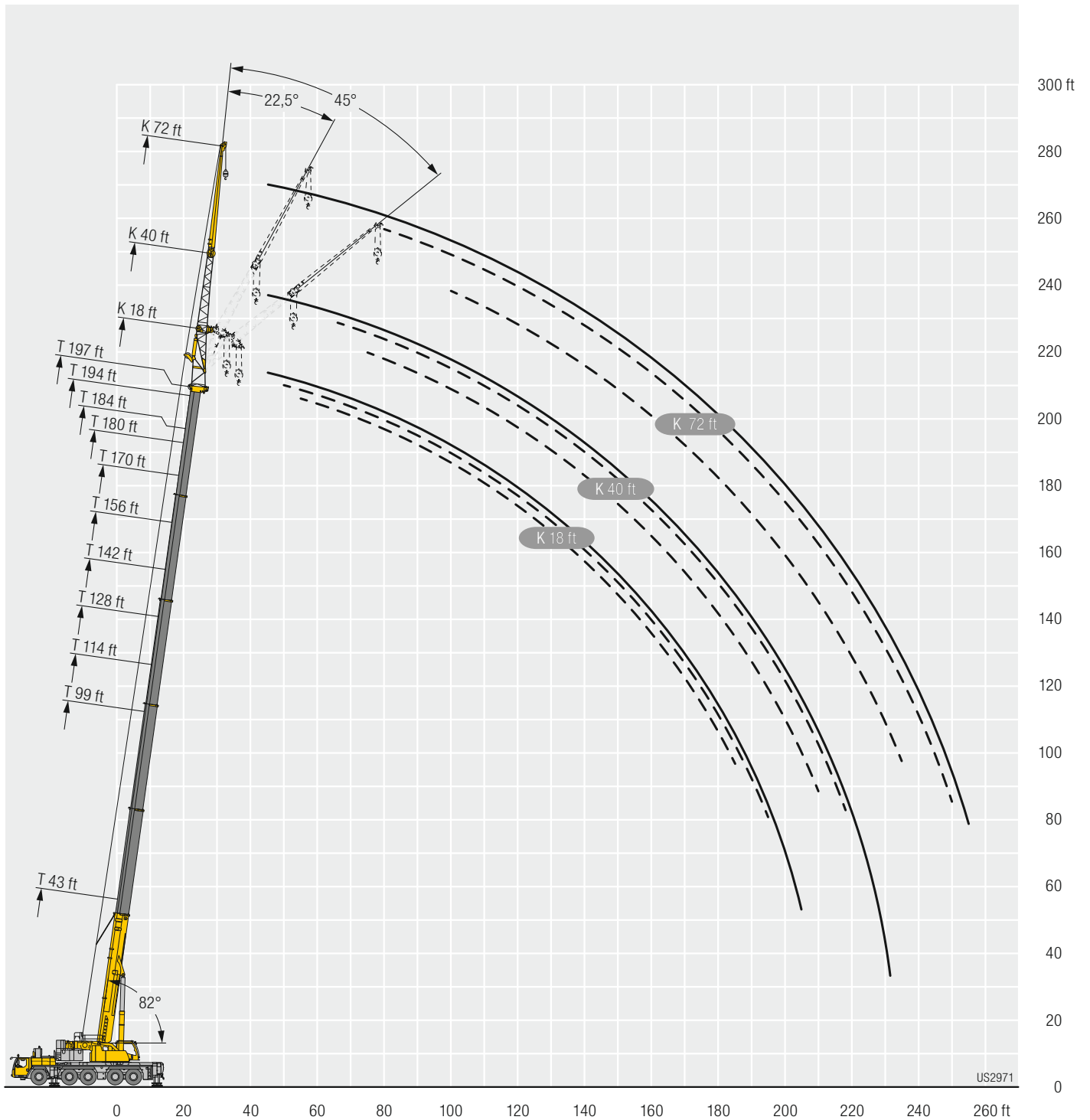

# Lifting capacities Forces de levage

**TNZK**



	43 ft			99 ft			114 ft			128 ft			142 ft			156 ft			
	0°	22,5°	45°	0°	22,5°	45°	0°	22,5°	45°	0°	22,5°	45°	0°	22,5°	45°	0°	22,5°	45°	
12	40.2																		12
13	40.2																		13
14	40.2																		14
15	39.8																		15
16	39.5																		16
17	39.1																		17
18	38.8																		18
19	38.4																		19
20	38																		20
22	37			40.2															22
24	35.9			40.1			38.2												24
26	34.7			39.7			38.2												26
28	33.6			39.3			37.9			35.5									28
30	32.5			38.8			37.6			35.4									30
32	31.5			38.3			37.3			35.3			32.5						32
34	30.5			37.8			36.9			35			32.5			29.3			34
36	29.5	23.7		37.1			36.4			34.6			32.2			29.2			36
38	28.5	23		36.4			35.9			34.1			31.9			29			38
40	27.6	22.3		35.6			35.2			33.7			31.5			28.8			40
45	25	20.6		33.8	24		33.6			32.5			30.6			28.1			45
50	22.3	19.3		32	22.8		32.1	23		31.4			29.7			27.4			50
55	20.1	18.1	15.2	30.4	21.8		30.6	22		30.1	21.9		28.8	21.5		26.8			55
60	18.2	16.9	14.6	28.8	20.7		29.2	21		28.9	21		27.9	20.8		26.1	20.3		60
65	16.6	15.8	14.1	27.3	19.8	15.4	27.9	20.2	15.4	27.8	20.2		27	20		25.4	19.6		65
70	15.3	14.9	13.6	25.5	19	15	26.7	19.4	15	26.7	19.5	15	26	19.3		24.7	18.9		70
75	14.1	14	13	23.7	18.3	14.6	25.3	18.6	14.7	25.6	18.8	14.7	25.1	18.7	14.6	24	18.4	14.4	75
80	13	13.3	12.6	22	17.5	14.3	23.8	18	14.4	24.6	18.1	14.4	24.3	18.1	14.3	23.3	17.8	14.2	80
85	12.1	12.7	12.3	20.6	16.8	14	22.3	17.3	14.1	23.4	17.5	14.1	23.4	17.5	14.1	22.6	17.2	13.9	85
90	11.3	12.1	12.1	19.3	16.2	13.7	20.9	16.6	13.8	22.1	16.9	13.8	22.4	16.9	13.8	21.9	16.7	13.7	90
95	10.7	11.8		18.1	15.5	13.4	19.7	16.1	13.6	20.8	16.3	13.6	21.5	16.4	13.6	21.1	16.2	13.5	95
100	10.1			17.1	15	13.1	18.5	15.5	13.3	19.7	15.8	13.3	20.4	15.9	13.4	20.3	15.7	13.3	100
105				16.1	14.5	12.9	17.5	15	13	18.7	15.3	13.1	19.4	15.4	13.1	19.6	15.2	13	105
110				15.3	14	12.6	16.6	14.5	12.8	17.8	14.8	12.9	18.5	14.9	12.9	18.8	14.8	12.8	110
115				14.5	13.5	12.4	15.8	14	12.6	16.9	14.3	12.7	17.7	14.5	12.7	18.1	14.4	12.6	115
120				13.8	13.1	12.3	15	13.6	12.4	16.1	14	12.5	16.9	14.1	12.5	17.3	14.1	12.4	120
125				13.1	12.7	12.2	14.3	13.2	12.3	15.4	13.6	12.3	16.2	13.7	12.3	16.7	13.7	12.3	125
130				12.5	12.4	12.2	13.7	12.9	12.2	14.7	13.2	12.2	15.5	13.4	12.2	16	13.4	12.1	130
135				11.9	12.1	12.1	13.1	12.6	12.1	14.1	12.9	12.1	14.9	13.1	12	15.4	13.1	12	135
140				11.4	11.9		12.5	12.3	12.1	13.5	12.6	12	14.3	12.8	11.9	14.8	12.8	11.9	140
145				11	11.8		12	12	12.1	13	12.3	11.9	13.7	12.5	11.9	14.3	12.6	11.8	145
150				10.6			11.5	11.8	12.1	12.5	12.1	11.9	13.2	12.3	11.8	13.8	12.3	11.7	150
155				10.2			11.1	11.7		12	11.9	11.9	12.8	12	11.8	13.3	12.1	11.6	155
160							10.7	11.6		11.6	11.7	11.9	12.3	11.8	11.8	12.9	11.9	11.6	160
165							10.4			11.2	11.5		11.9	11.6	11.8	12.5	11.7	11.6	165
170							10.1			10.8	11.5		11.5	11.5	11.8	12.1	11.5	11.6	170
175										10.5	11.4		11.2	11.4	11.1	11.7	11.4	11.6	175
180										10.2			10.9	11.3		11.4	11.3	11.6	180
185										9.6			10.6	11.3		11.1	11.2	11.6	185
190													10.3			10.8	11.1	9.3	190
195													10			10.6	11.1		195
200																10.3	11.1		200
205																10.1			205
210																8.6			210

t\_259\_106\_12151 / 32151\_00\_000

# Lifting capacities Forces de levage

**TNZK**



↙ ↘	170 ft			180 ft			184 ft 63 ft			194 ft			197 ft			↙ ↘
	0°	22,5°	45°	0°	22,5°	45°	0°	22,5°	45°	0°	22,5°	45°	0°	22,5°	45°	
38	25.6															38
40	25.5			21												40
45	25.2			20.9			21.1			19.1			18.8			45
50	24.7			20.9			21.1			19.1			18.7			50
55	24.2			20.8			21			19			18.7			55
60	23.7			20.6			20.8			19			18.6			60
65	23.2	18.8		20.3			20.5			18.8			18.5			65
70	22.8	18.3		20	17.7		20.2	17.9		18.6			18.3			70
75	22.3	17.7		19.7	17.3		19.9	17.5		18.4	16.6		18.1	16.5		75
80	21.7	17.2	13.9	19.4	16.8		19.6	17		18.2	16.2		17.9	16.1		80
85	21.2	16.7	13.7	19	16.4	14.1	19.3	16.6	14.3	18	15.9		17.7	15.7		85
90	20.7	16.2	13.5	18.7	16	13.9	18.9	16.2	14	17.7	15.5	13.6	17.5	15.4	13.5	90
95	20.1	15.7	13.2	18.3	15.7	13.7	18.6	15.9	13.8	17.4	15.2	13.4	17.2	15.1	13.4	95
100	19.5	15.3	13	18	15.3	13.4	18.2	15.5	13.5	17.1	14.9	13.2	16.9	14.8	13.2	100
105	18.9	15	12.8	17.7	14.9	13.2	17.9	15.2	13.3	16.9	14.6	13	16.7	14.5	13	105
110	18.3	14.6	12.6	17.4	14.6	13.1	17.6	14.8	13.1	16.6	14.3	12.8	16.4	14.2	12.8	110
115	17.8	14.2	12.4	17	14.3	12.9	17.2	14.5	13	16.3	14	12.7	16.2	14	12.6	115
120	17.2	13.9	12.3	16.7	14	12.8	16.9	14.2	12.8	16.1	13.8	12.6	15.9	13.7	12.5	120
125	16.7	13.6	12.1	16.3	13.8	12.6	16.5	13.9	12.7	15.8	13.5	12.4	15.7	13.5	12.4	125
130	16.1	13.3	12	15.9	13.5	12.5	16.1	13.7	12.5	15.5	13.3	12.3	15.4	13.2	12.3	130
135	15.6	13	11.8	15.5	13.3	12.4	15.8	13.4	12.4	15.2	13.1	12.2	15.1	13	12.2	135
140	15	12.7	11.7	15.1	13.1	12.3	15.4	13.2	12.3	14.9	12.8	12.1	14.8	12.8	12	140
145	14.5	12.5	11.6	14.7	12.8	12.2	15.1	13	12.2	14.6	12.7	12	14.5	12.6	12	145
150	14.1	12.3	11.6	14.2	12.6	12.1	14.7	12.7	12.1	14.2	12.5	12	14.2	12.4	11.9	150
155	13.6	12	11.5	13.8	12.4	12.1	14.4	12.5	12.1	13.8	12.3	11.9	13.8	12.2	11.9	155
160	13.2	11.8	11.5	13.3	12.2	12	14.1	12.4	12	13.4	12.1	11.9	13.4	12.1	11.8	160
165	12.8	11.7	11.5	12.9	12.1	12	13.8	12.2	12	13	12	11.8	13	11.9	11.8	165
170	12.5	11.5	11.5	12.4	11.9	12	13.5	12	12	12.6	11.8	11.8	12.6	11.8	11.8	170
175	12.1	11.4	11.5	11.9	11.7	12	13.2	11.9	12	12.1	11.7	11.8	12.2	11.6	11.7	175
180	11.8	11.2	11.5	11.5	11.5	11.7	12.9	11.7	12	11.7	11.5	11.8	11.8	11.5	11.7	180
185	11.5	11.1	11.5	11.1	11.3	11.5	12.7	11.6	12	11.4	11.3	11.7	11.4	11.3	11.7	185
190	11.2	11	11.5	10.7	10.9	11.2	12.4	11.5	12	11	11	11.5	11	11	11.5	190
195	10.9	10.9	11.5	10.3	10.5	10.8	12.1	11.4	12	10.7	10.7	11.1	10.7	10.8	11.1	195
200	10.7	10.9	10.4	10	10.2	10.4	11.4	11.4	12	10.3	10.5	10.8	10.3	10.5	10.8	200
205	10.4	10.8		9.6	9.8	10.1	10.7	11.3	11.7	10	10.1	10.5	10	10.2	10.5	205
210	10.2	10.8		9.3	9.5	9.3	10.1	10.7	10.8	9.7	9.9	10.1	9.7	9.9	10.2	210
215	10			9	9.2		9.4	10	8.8	9.3	9.6	9.9	9.2	9.6	9.8	215
220	8.4			8.7	8.9		8.8	9.3	6.8	8.8	9.2	9.5	8.6	9.2	9.3	220
225	5.7			8.5			8.3	8.7		8.2	8.7	8.1	8	8.6	8.6	225
230				7.3			7.5			7.7	8.1		7.5	8	7.1	230
235				4.7			5.7			7.2	7.5		7.1	7.4		235
240							2.9			6.4			6.6			240
245										4.7			5.2			245
250													3.1			250

t\_259\_106\_12151 / 32151\_00\_000

# Lifting capacities Forces de levage

**TNZK**

Jib height (ft)	43 ft			99 ft			114 ft			128 ft			142 ft			156 ft			Jib height (ft)
	0°	22,5°	45°	0°	22,5°	45°	0°	22,5°	45°	0°	22,5°	45°	0°	22,5°	45°	0°	22,5°	45°	
16	25.2																		16
17	25.2																		17
18	25.2																		18
19	25.2																		19
20	25.2																		20
22	25																		22
24	24.5																		24
26	23.9			25.2															26
28	23.2			25.2			24.2												28
30	22.6			25.2			24.2												30
32	21.9			25.1			24.2			22.8									32
34	21.1			25			24.1			22.8			20.6						34
36	20.4			24.6			24			22.7			20.5						36
38	19.7			24.2			23.7			22.6			20.5			18.6			38
40	19			23.7			23.3			22.4			20.4			18.6			40
45	17.5			22.6			22.4			21.7			20.3			18.5			45
50	16	12.9		21.4			21.5			20.9			20.1			18.4			50
55	14.8	12		20.1			20.4			20.1			19.6			18.2			55
60	13.7	11.2		18.9	13		19.3			19.2			19			17.8			60
65	12.6	10.5		17.8	12.4		18.3	12.5		18.2	12.4		18.4			17.4			65
70	11.6	9.9		16.8	11.8		17.3	11.9		17.4	12.1		17.8	12.8		16.9			70
75	10.7	9.4	8	15.8	11.3		16.4	11.5		16.5	11.6		17.1	12.3		16.4	12.1		75
80	9.8	8.9	7.7	15	10.8		15.5	11		15.7	11.2		16.5	11.9		15.9	11.7		80
85	9.1	8.4	7.4	14.2	10.4	8.1	14.7	10.5	8.1	15	10.8		15.9	11.5		15.4	11.3		85
90	8.4	8	7.2	13.4	10	7.8	14	10.2	7.9	14.3	10.5	8.2	15.2	11.1	8.4	14.8	10.9		90
95	7.8	7.7	7	12.7	9.6	7.7	13.3	9.8	7.7	13.6	10.1	8.1	14.6	10.7	8.3	14.3	10.6	8.2	95
100	7.4	7.4	6.9	12	9.3	7.5	12.7	9.5	7.5	13.1	9.8	7.9	14	10.4	8.1	13.8	10.3	8	100
105	7	7.1	6.8	11.3	8.9	7.3	12	9.1	7.4	12.5	9.5	7.7	13.5	10.1	7.9	13.3	10	7.9	105
110	6.6	7	6.8	10.7	8.6	7.2	11.4	8.8	7.3	11.9	9.2	7.6	13	9.8	7.8	12.8	9.7	7.7	110
115	6.3	6.8	6.8	10.1	8.4	7.1	10.9	8.6	7.1	11.4	9	7.5	12.4	9.5	7.6	12.4	9.4	7.6	115
120	6	6.8		9.5	8.1	7	10.3	8.3	7	10.9	8.8	7.4	12	9.2	7.5	12	9.2	7.5	120
125				9	7.8	6.9	9.8	8.1	6.9	10.5	8.5	7.3	11.5	9	7.4	11.6	9	7.4	125
130				8.6	7.6	6.9	9.3	7.9	6.9	10.1	8.3	7.2	11.1	8.7	7.3	11.2	8.7	7.3	130
135				8.1	7.4	6.8	8.9	7.6	6.8	9.7	8.1	7.2	10.7	8.5	7.3	10.8	8.5	7.2	135
140				7.7	7.3	6.8	8.5	7.5	6.8	9.3	7.9	7.1	10.3	8.3	7.2	10.5	8.3	7.1	140
145				7.4	7.1	6.8	8.1	7.3	6.7	9	7.7	7.1	10	8.1	7.1	10.1	8.2	7.1	145
150				7.1	7	6.8	7.7	7.2	6.7	8.6	7.6	7.1	9.6	8	7.1	9.8	8	7	150
155				6.9	6.9	6.8	7.4	7.1	6.7	8.3	7.5	7.1	9.2	7.8	7.1	9.5	7.8	7	155
160				6.7	6.9		7.2	6.9	6.7	8	7.4	7.1	8.9	7.6	7	9.2	7.7	7	160
165				6.4	6.8		6.9	6.9	6.7	7.7	7.3	7.1	8.5	7.5	7	8.9	7.5	6.9	165
170				6.2	6.8		6.7	6.8	6.7	7.4	7.2	7.1	8.2	7.4	7	8.6	7.4	6.9	170
175				6			6.5	6.8		7.2	7.1	7.1	7.9	7.3	7	8.3	7.3	6.9	175
180				6			6.3	6.7		7	7.1	7.1	7.6	7.2	7	8	7.2	6.9	180
185							6.1			6.8	7.1		7.4	7.1	7	7.7	7.1	6.9	185
190							6			6.6	7.1		7.2	7.1	7	7.5	7.1	6.9	190
195										6.5	7.1		7	7	7	7.3	7	6.9	195
200										6.3			6.8	7		7.1	7	6.9	200
205										6.2			6.6	7		6.9	6.9	6.9	205
210													6.5			6.8	6.9	6.9	210
215													6.3			6.6	6.9		215
220													6.2			6.5	6.9		220
225																6.4			225
230																6.2			230
235																5			235

t\_259\_106\_14151 / 34151\_00\_000

# Lifting capacities Forces de levage

**TNZK**



↙ ↘	170 ft			180 ft			184 ft 86 ft			194 ft			197 ft			↙ ↘
	0°	22,5°	45°	0°	22,5°	45°	0°	22,5°	45°	0°	22,5°	45°	0°	22,5°	45°	
45	16.5			14.2			14.4			13			12.8			45
50	16.4			14.2			14.3									50
55	16.3			14.1			14.2			13			12.8			55
60	16.2			14.1			14.2			13			12.7			60
65	16			14			14.1			12.9			12.7			65
70	15.6			13.8			14			12.9			12.6			70
75	15.3			13.6			13.8			12.7			12.5			75
80	14.9	11.3		13.4			13.5			12.6			12.4			80
85	14.5	10.9		13.1	10.3		13.3	10.4		12.4	10		12.2			85
90	14.1	10.6		12.8	10		13	10.1		12.2	9.8		12	9.7		90
95	13.7	10.3		12.5	9.8		12.7	9.9		12	9.6		11.8	9.5		95
100	13.2	10	7.9	12.1	9.5		12.4	9.6		11.7	9.3		11.6	9.3		100
105	12.8	9.8	7.7	11.8	9.3	7.5	12	9.4	7.6	11.4	9.1		11.3	9.1		105
110	12.4	9.5	7.6	11.5	9.1	7.4	11.7	9.2	7.5	11.2	8.9	7.3	11.1	8.9	7.3	110
115	12	9.3	7.5	11.2	8.9	7.3	11.4	9	7.4	10.9	8.7	7.3	10.8	8.7	7.2	115
120	11.7	9	7.4	10.9	8.7	7.3	11.1	8.8	7.3	10.6	8.5	7.2	10.5	8.5	7.2	120
125	11.3	8.8	7.3	10.6	8.5	7.2	10.8	8.6	7.2	10.4	8.4	7.1	10.3	8.3	7.1	125
130	11	8.6	7.2	10.3	8.3	7.1	10.5	8.4	7.1	10.1	8.2	7	10.1	8.2	7	130
135	10.6	8.4	7.1	10.1	8.1	7	10.2	8.2	7.1	9.9	8.1	7	9.8	8	7	135
140	10.3	8.2	7.1	9.8	8	7	9.9	8.1	7	9.7	7.9	6.9	9.6	7.9	6.9	140
145	10	8.1	7	9.6	7.8	6.9	9.7	7.9	7	9.4	7.7	6.9	9.4	7.7	6.9	145
150	9.7	7.9	7	9.3	7.7	6.9	9.5	7.8	6.9	9.2	7.6	6.8	9.2	7.6	6.8	150
155	9.5	7.8	7	9.1	7.6	6.9	9.2	7.6	6.9	9	7.5	6.8	9	7.5	6.8	155
160	9.2	7.6	6.9	8.9	7.5	6.8	9	7.5	6.8	8.8	7.4	6.8	8.8	7.4	6.8	160
165	9	7.5	6.9	8.7	7.4	6.8	8.8	7.4	6.8	8.6	7.3	6.8	8.6	7.3	6.7	165
170	8.7	7.4	6.9	8.5	7.3	6.8	8.6	7.3	6.8	8.4	7.2	6.7	8.4	7.2	6.7	170
175	8.5	7.3	6.9	8.3	7.2	6.8	8.4	7.2	6.8	8.2	7.1	6.7	8.2	7.1	6.7	175
180	8.3	7.2	6.9	8.1	7.1	6.8	8.2	7.1	6.8	8.1	7.1	6.7	8.1	7	6.7	180
185	8	7.1	6.9	7.9	7	6.8	8	7.1	6.8	7.9	7	6.7	7.9	7	6.7	185
190	7.8	7	6.9	7.7	7	6.8	7.8	7	6.8	7.8	6.9	6.7	7.8	6.9	6.7	190
195	7.5	7	6.9	7.5	6.9	6.8	7.7	6.9	6.8	7.6	6.9	6.7	7.6	6.8	6.7	195
200	7.4	6.9	6.9	7.3	6.8	6.8	7.5	6.9	6.8	7.5	6.8	6.7	7.5	6.8	6.7	200
205	7.2	6.9	6.9	7.2	6.8	6.8	7.3	6.8	6.8	7.3	6.8	6.7	7.4	6.8	6.7	205
210	7	6.9	6.9	7	6.8	6.8	7.2	6.8	6.8	7.2	6.7	6.7	7.2	6.7	6.7	210
215	6.9	6.9	6.9	6.9	6.8	6.8	7	6.8	6.8	7.1	6.7	6.7	7.1	6.7	6.7	215
220	6.7	6.9	6.9	6.8	6.7	6.8	6.9	6.7	6.8	6.9	6.7	6.7	6.9	6.7	6.7	220
225	6.6	6.9		6.6	6.7	6.8	6.7	6.7	6.8	6.8	6.7	6.7	6.8	6.7	6.7	225
230	6.4	6.9		6.5	6.7	6.8	6.6	6.7	6.8	6.7	6.7	6.7	6.7	6.7	6.7	230
235	6.3			6.4	6.7		6.5	6.7	6.8	6.6	6.7	6.7	6.6	6.6	6.7	235
240	6.2			6.3	6.7		6.4	6.7	6.8	6.5	6.7	6.7	6.5	6.6	6.7	240
245	5.5			6.2			6.3	6.7		6.4	6.7	6.7	6.4	6.6	6.7	245
250				6.1			6.1			6.2	6.6		6	6.5	6.5	250
255				4.6			4.9			5.8	6.2		5.6	6.1		255
260							3			5.2			5.3			260
265										4			4.3			265
270													2.7			270

L\_259\_106\_14151 / 34151\_00\_000

# Lifting heights Hauteurs de levage

TNZK

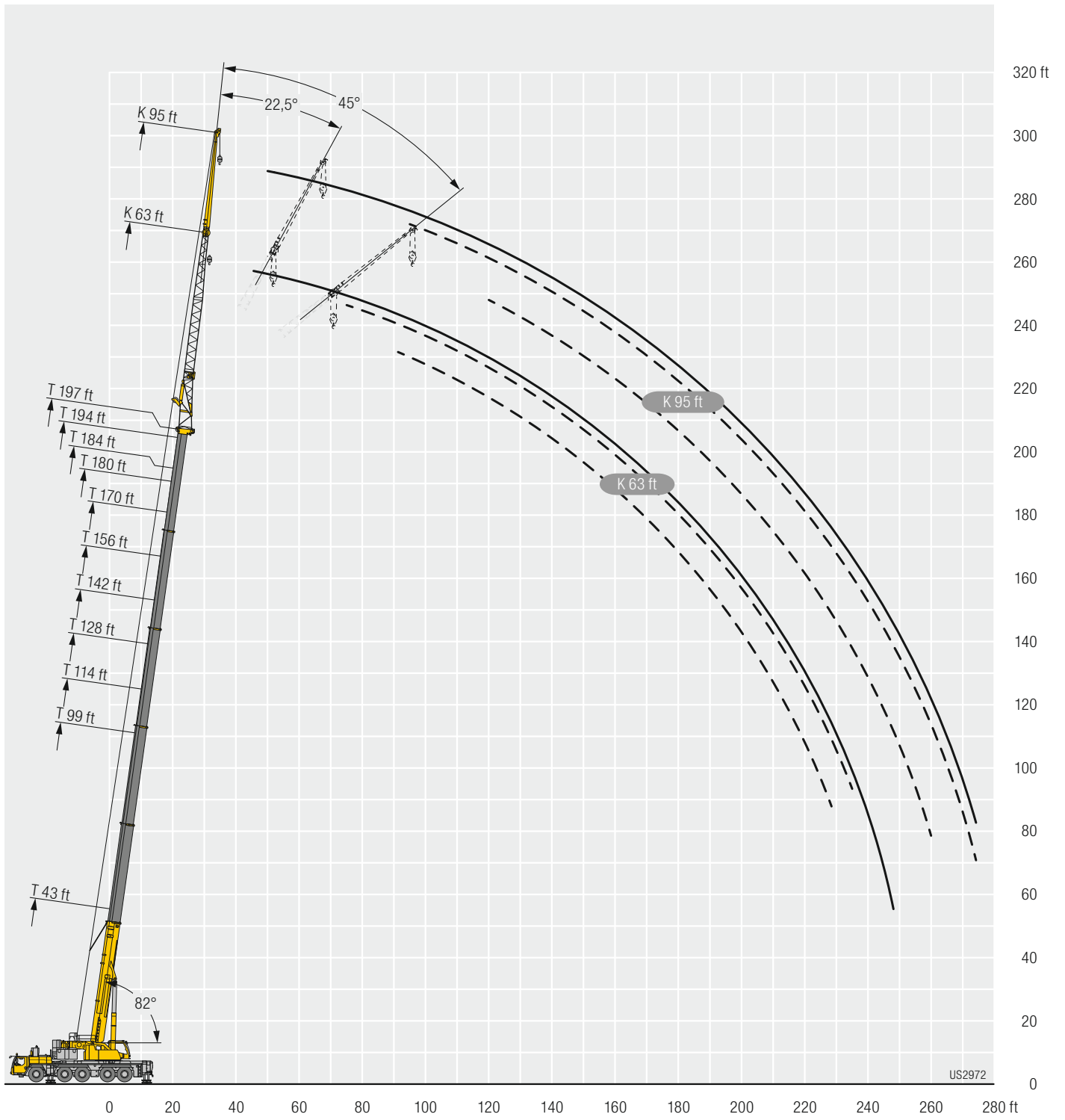



# Lifting capacities Forces de levage

**TNZK**



Jib	43 ft			99 ft			114 ft			128 ft			142 ft			156 ft			Jib
	0°	22,5°	45°	0°	22,5°	45°	0°	22,5°	45°	0°	22,5°	45°	0°	22,5°	45°	0°	22,5°	45°	
16	16.2																		16
17	16.2																		17
18	16.2																		18
19	16.2																		19
20	16.2																		20
22	16.3																		22
24	16.3																		24
26	16.3			16.2															26
28	16.2			16.2			15.9												28
30	16.2			16.2			15.9												30
32	16.2			16.2			15.9			15.3									32
34	16.1			16.2			15.9			15.3			14.6						34
36	16			16.2			15.9			15.3			14.5						36
38	15.7			16.2			15.8			15.2			14.5			13.6			38
40	15.5			16.2			15.8			15.2			14.5			13.6			40
45	14.7			16.2			15.7			15.1			14.4			13.5			45
50	13.8			16.1			15.7			15.1			14.4			13.5			50
55	13	11.1		15.8			15.6			15			14.3			13.4			55
60	12.2	10.5		15.3			15.2			14.9			14.2			13.4			60
65	11.5	9.9		14.7	11.2		14.8			14.6			14.1			13.3			65
70	10.8	9.3		14.1	10.8		14.3	10.8		14.2	10.7		13.9			13.2			70
75	10.1	8.8		13.6	10.3		13.7	10.4		13.7	10.4		13.5	10.3		13			75
80	9.5	8.4	7.2	13	9.9		13.2	10		13.2	10		13.1	9.9		12.6	9.7		80
85	9	7.9	7	12.4	9.5		12.7	9.6		12.8	9.7		12.6	9.6		12.3	9.4		85
90	8.4	7.6	6.8	11.9	9.2	7.3	12.2	9.3		12.3	9.3		12.2	9.3		11.9	9.1		90
95	8	7.3	6.6	11.4	8.8	7.1	11.7	9	7.1	11.9	9	7.1	11.8	9		11.6	8.9		95
100	7.5	7	6.4	10.9	8.5	6.9	11.2	8.7	7	11.5	8.7	7	11.4	8.7	6.9	11.2	8.6		100
105	7.1	6.7	6.3	10.4	8.2	6.8	10.8	8.4	6.8	11	8.4	6.8	11.1	8.5	6.8	10.9	8.4	6.7	105
110	6.7	6.5	6.2	9.9	7.9	6.7	10.4	8.1	6.7	10.6	8.2	6.7	10.7	8.2	6.7	10.5	8.1	6.6	110
115	6.4	6.4	6.1	9.5	7.7	6.6	10	7.8	6.6	10.2	8	6.6	10.3	8	6.6	10.2	7.9	6.6	115
120	6.1	6.2	6.1	9.1	7.5	6.5	9.6	7.6	6.5	9.8	7.7	6.5	9.9	7.8	6.5	9.9	7.7	6.5	120
125	5.8	6.1	6.1	8.7	7.3	6.4	9.2	7.4	6.4	9.5	7.5	6.4	9.6	7.6	6.4	9.6	7.5	6.4	125
130	5.6	6		8.4	7.1	6.3	8.9	7.2	6.3	9.1	7.4	6.3	9.3	7.4	6.3	9.3	7.4	6.3	130
135				8	6.9	6.2	8.5	7.1	6.2	8.8	7.2	6.3	9	7.2	6.3	9	7.2	6.2	135
140				7.7	6.8	6.2	8.2	6.9	6.2	8.5	7	6.2	8.7	7.1	6.2	8.7	7.1	6.2	140
145				7.4	6.6	6.1	7.9	6.8	6.1	8.2	6.9	6.2	8.4	7	6.1	8.5	7	6.1	145
150				7.1	6.5	6.1	7.6	6.6	6.1	8	6.8	6.1	8.2	6.8	6.1	8.2	6.8	6	150
155				6.8	6.4	6.1	7.3	6.5	6.1	7.7	6.6	6.1	7.9	6.7	6	8	6.7	6	155
160				6.6	6.3	6.1	7.1	6.4	6.1	7.5	6.5	6	7.7	6.6	6	7.8	6.6	5.9	160
165				6.3	6.2	6.1	6.8	6.3	6.1	7.3	6.4	6	7.5	6.5	6	7.6	6.5	5.9	165
170				6.1	6.2	6.1	6.6	6.2	6.1	7	6.3	6	7.3	6.4	6	7.4	6.4	5.9	170
175				5.9	6.1	6.1	6.4	6.1	6.1	6.8	6.2	6	7.1	6.3	6	7.2	6.3	5.9	175
180				5.7	6.1		6.2	6.1	6.1	6.6	6.1	6	6.9	6.2	6	7.1	6.2	5.9	180
185				5.6			6	6.1	6.1	6.4	6.1	6	6.7	6.1	6	6.9	6.2	5.9	185
190							5.8	6.1		6.2	6.1	6	6.5	6.1	6	6.8	6.1	5.9	190
195							5.7	6.1		6	6	6	6.3	6	6	6.6	6	5.9	195
200							5.5	6.1		5.9	6	6	6.2	6	6	6.4	6	5.9	200
205										5.7	6		6	6	6	6.3	5.9	5.9	205
210										5.6			5.9	6	6	6.1	5.9	5.9	210
215										5.5			5.7	6	6	6	5.9	5.9	215
220													5.6	6		5.9	5.9	5.9	220
225													5.5			5.7	5.9	5.9	225
230													5.4			5.6	5.9		230
235																5.5	5.9		235
240																5.5			240
245																3.6			245

t\_259\_106\_15151 / 35151\_00\_000

# Lifting capacities Forces de levage

**TNZK**

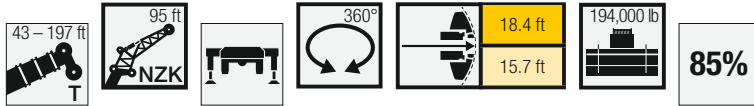

↙ ↘	170 ft			180 ft			184 ft 95 ft			194 ft			197 ft			↙ ↘
	0°	22,5°	45°	0°	22,5°	45°	0°	22,5°	45°	0°	22,5°	45°	0°	22,5°	45°	
45	12.5			11.1						10.4			10.2			45
50	12.4			11.1			11.2									50
55	12.4			11			11.1			10.3			10.2			55
60	12.3			11			11.1			10.3			10.1			60
65	12.3			11			11.1			10.3			10.1			65
70	12.2			11			11			10.2			10.1			70
75	12.2			10.9			11			10.2			10.1			75
80	12			10.9			11			10.2			10.1			80
85	11.7	9.1		10.7			10.8			10.2			10			85
90	11.4	8.9		10.5	8.4		10.6	8.5		10.1	8.2		9.9			90
95	11.1	8.6		10.2	8.2		10.4	8.3		9.8	8		9.8	8		95
100	10.8	8.4		10	8		10.1	8.1		9.6	7.8		9.6	7.8		100
105	10.5	8.2		9.8	7.8		9.9	7.9		9.4	7.7		9.4	7.6		105
110	10.2	8	6.6	9.5	7.6		9.7	7.7		9.2	7.5		9.2	7.5		110
115	9.9	7.8	6.5	9.3	7.5	6.3	9.4	7.5	6.3	9	7.4	6.2	9	7.3		115
120	9.6	7.6	6.4	9.1	7.3	6.2	9.2	7.4	6.3	8.8	7.2	6.2	8.8	7.2	6.2	120
125	9.4	7.4	6.3	8.8	7.2	6.2	9	7.3	6.2	8.6	7.1	6.1	8.6	7.1	6.1	125
130	9.1	7.3	6.2	8.6	7.1	6.1	8.7	7.1	6.1	8.4	7	6	8.4	7	6	130
135	8.9	7.1	6.1	8.4	7	6.1	8.5	7	6.1	8.2	6.9	6	8.2	6.8	6	135
140	8.6	7	6.1	8.2	6.8	6	8.3	6.9	6	8	6.8	5.9	8	6.7	5.9	140
145	8.4	6.9	6	8	6.7	6	8.1	6.8	6	7.9	6.7	5.9	7.8	6.6	5.9	145
150	8.2	6.8	6	7.8	6.6	5.9	7.9	6.6	5.9	7.7	6.6	5.9	7.7	6.5	5.8	150
155	8	6.7	6	7.6	6.5	5.9	7.7	6.5	5.9	7.6	6.5	5.8	7.5	6.4	5.8	155
160	7.7	6.6	5.9	7.5	6.4	5.8	7.5	6.5	5.9	7.4	6.4	5.8	7.4	6.4	5.8	160
165	7.5	6.5	5.9	7.3	6.4	5.8	7.4	6.4	5.8	7.3	6.3	5.8	7.3	6.3	5.7	165
170	7.4	6.4	5.9	7.2	6.3	5.8	7.3	6.3	5.8	7.1	6.2	5.7	7.1	6.2	5.7	170
175	7.2	6.3	5.9	7	6.2	5.8	7.1	6.2	5.8	7	6.2	5.7	7	6.1	5.7	175
180	7.1	6.2	5.8	6.9	6.1	5.8	7	6.1	5.8	6.9	6.1	5.7	6.9	6.1	5.7	180
185	6.9	6.1	5.8	6.8	6	5.8	6.9	6.1	5.8	6.8	6	5.7	6.8	6	5.7	185
190	6.8	6.1	5.8	6.7	6	5.8	6.7	6	5.8	6.7	5.9	5.7	6.6	5.9	5.7	190
195	6.7	6	5.8	6.6	5.9	5.8	6.6	5.9	5.8	6.6	5.9	5.7	6.5	5.9	5.7	195
200	6.6	6	5.8	6.5	5.9	5.8	6.5	5.9	5.8	6.5	5.8	5.7	6.4	5.8	5.7	200
205	6.4	5.9	5.8	6.3	5.8	5.8	6.4	5.8	5.8	6.4	5.8	5.7	6.4	5.8	5.7	205
210	6.3	5.9	5.8	6.3	5.8	5.8	6.3	5.8	5.8	6.3	5.8	5.7	6.2	5.7	5.7	210
215	6.2	5.8	5.8	6.1	5.8	5.8	6.2	5.8	5.8	6.2	5.7	5.7	6.2	5.7	5.7	215
220	6	5.8	5.8	6	5.7	5.8	6.1	5.8	5.8	6.1	5.7	5.7	6.1	5.7	5.7	220
225	5.9	5.8	5.8	5.9	5.7	5.8	6	5.7	5.8	6	5.7	5.7	6	5.7	5.7	225
230	5.8	5.8	5.8	5.8	5.7	5.8	5.9	5.7	5.8	5.9	5.7	5.7	5.9	5.6	5.7	230
235	5.7	5.8	5.8	5.7	5.7	5.8	5.8	5.7	5.8	5.8	5.7	5.7	5.9	5.6	5.7	235
240	5.6	5.8	5.8	5.6	5.7	5.8	5.7	5.7	5.8	5.8	5.7	5.7	5.8	5.6	5.7	240
245	5.5	5.8		5.6	5.7	5.8	5.6	5.7	5.8	5.7	5.7	5.7	5.7	5.6	5.7	245
250	5.4	5.8		5.5	5.7	5.8	5.6	5.7	5.8	5.6	5.7	5.7	5.6	5.6	5.7	250
255	4.7			5.4	5.7		5.5	5.7		5.6	5.7	5.7	5.6	5.6	5.7	255
260				5.4	5.7		5.4	5.7		5.5	5.7	5.7	5.5	5.6	5.7	260
265				3.8			4.2			5.3	5.7		5.2	5.6		265
270										4.7	5.4		4.8	5.3		270
275										3.3			3.7	4.9		275

t\_259\_106\_15151 / 35151\_00\_000

# Lifting capacities Forces de levage

**TNZK**



43 ft	99 ft			114 ft			128 ft			142 ft			156 ft			43 ft	
	0°	22,5°	45°	0°	22,5°	45°	0°	22,5°	45°	0°	22,5°	45°	0°	22,5°	45°		
20	12.1															20	
22	12.1															22	
24	12															24	
26	12															26	
28	12															28	
30	11.9			12.1												30	
32	11.9			12.1			11.7									32	
34	11.8			12			11.7									34	
36	11.8			12			11.6			11.2						36	
38	11.7			12			11.6			11.1						38	
40	11.6			12			11.6			11.1			10.5			40	
45	11			11.9			11.5			11			10.5		9.8	45	
50	10.4			11.8			11.4			11			10.4		9.7	50	
55	9.8			11.6			11.4			10.9			10.3		9.7	55	
60	9.2			11.2			11.1			10.8			10.3		9.6	60	
65	8.6	7.2		10.8			10.8			10.6			10.2		9.5	65	
70	8.1	6.9		10.3			10.4			10.2			10		9.5	70	
75	7.6	6.5		9.9			10			9.9			9.7		9.3	75	
80	7.1	6.2		9.4	7		9.6	7		9.5			9.3		9	80	
85	6.7	5.9		9	6.7		9.2	6.8		9.1	6.8		9		8.7	85	
90	6.4	5.6		8.5	6.5		8.8	6.5		8.8	6.5		8.7	6.5	8.4	90	
95	6	5.4		8.2	6.3		8.4	6.3		8.4	6.3		8.4	6.3	8.1	95	
100	5.8	5.1	4.5	7.8	6		8	6.1		8.1	6.1		8	6.1	7.9	100	
105	5.5	4.9	4.3	7.4	5.8		7.7	5.9		7.8	5.9		7.8	5.9	7.6	105	
110	5.2	4.7	4.2	7.1	5.6	4.5	7.4	5.7		7.5	5.7		7.5	5.7	7.4	110	
115	4.9	4.5	4.1	6.8	5.4	4.4	7.1	5.5	4.4	7.2	5.6	4.4	7.2	5.5	7.1	115	
120	4.7	4.4	4	6.6	5.3	4.3	6.8	5.3	4.3	6.9	5.4	4.3	7	5.4	4.3	6.9	120
125	4.5	4.2	3.9	6.3	5.1	4.2	6.6	5.2	4.3	6.7	5.2	4.2	6.8	5.2	4.2	6.7	125
130	4.3	4.1	3.8	6	5	4.1	6.3	5.1	4.2	6.5	5.1	4.2	6.5	5.1	4.2	6.5	130
135	4.1	3.9	3.7	5.8	4.8	4.1	6.1	4.9	4.1	6.2	5	4.1	6.3	5	4.1	6.3	135
140	3.9	3.8	3.7	5.6	4.7	4	5.8	4.8	4	6	4.8	4	6.1	4.9	4	6.1	140
145	3.7	3.8	3.7	5.4	4.5	3.9	5.7	4.7	4	5.8	4.7	4	5.9	4.7	3.9	5.9	145
150	3.5	3.7		5.2	4.4	3.9	5.5	4.5	3.9	5.7	4.6	3.9	5.7	4.6	3.9	5.8	150
155	3.4			5	4.3	3.8	5.3	4.4	3.8	5.5	4.5	3.8	5.6	4.5	3.8	5.6	155
160				4.9	4.2	3.8	5.1	4.3	3.8	5.3	4.4	3.8	5.4	4.4	3.8	5.5	160
165				4.7	4.1	3.7	4.9	4.2	3.8	5.1	4.3	3.8	5.2	4.3	3.7	5.3	165
170				4.5	4	3.7	4.8	4.1	3.7	5	4.2	3.7	5.1	4.2	3.7	5.2	170
175				4.4	3.9	3.7	4.6	4	3.7	4.8	4.1	3.7	4.9	4.1	3.7	5	175
180				4.2	3.9	3.7	4.5	4	3.7	4.7	4	3.7	4.8	4.1	3.6	4.9	180
185				4	3.8	3.7	4.4	3.9	3.7	4.5	3.9	3.6	4.7	4	3.6	4.8	185
190				3.9	3.8	3.7	4.2	3.8	3.7	4.4	3.9	3.6	4.5	3.9	3.6	4.6	190
195				3.8	3.7		4.1	3.8	3.7	4.3	3.8	3.6	4.4	3.9	3.6	4.5	195
200				3.6	3.7		3.9	3.7	3.7	4.2	3.8	3.6	4.3	3.8	3.6	4.4	200
205				3.5	3.7		3.8	3.7	3.7	4.1	3.7	3.6	4.2	3.7	3.6	4.3	205
210				3.4			3.7	3.7		3.9	3.7	3.6	4.1	3.7	3.6	4.2	210
215							3.6	3.7		3.8	3.7	3.6	4	3.7	3.6	4.1	215
220							3.5	3.7		3.7	3.6	3.6	3.9	3.6	3.6	4	220
225							3.4			3.6	3.6		3.8	3.6	3.6	3.9	225
230										3.5	3.6		3.7	3.6	3.6	3.9	230
235										3.4			3.6	3.6		3.8	235
240										3.4			3.5	3.6		3.7	240
245													3.5	3.6		3.6	245
250													3.4			3.5	250
255																3.5	255
260																3.4	260
265																3.4	265

t\_259\_106\_16151 / 36151\_00\_000

# Lifting capacities

## Forces de levage

**TNZK**



Lifting height (ft)	170 ft			180 ft			184 ft			194 ft			197 ft			Lifting height (ft)
	0°	22,5°	45°	0°	22,5°	45°	118 ft			0°	22,5°	45°	0°	22,5°	45°	
50	8.9			7.8			7.9						7.2			50
55	8.8			7.8			7.9			7.3			7.2			55
60	8.8			7.8			7.8			7.2			7.1			60
65	8.7			7.7			7.8			7.2			7.1			65
70	8.7			7.7			7.7			7.2			7.1			70
75	8.6			7.7			7.7			7.2			7.1			75
80	8.5			7.6			7.7			7.1			7.1			80
85	8.2			7.5			7.6			7.1			7			85
90	8			7.3			7.4			7			7			90
95	7.8	6		7.2			7.3			6.9			6.9			95
100	7.5	5.8		7	5.5		7.1	5.6		6.8			6.7			100
105	7.3	5.7		6.8	5.4		6.9	5.5		6.6	5.3		6.6	5.3		105
110	7.1	5.5		6.7	5.3		6.7	5.3		6.5	5.2		6.4	5.2		110
115	6.9	5.4		6.5	5.2		6.6	5.2		6.3	5.1		6.3	5.1		115
120	6.7	5.2		6.3	5		6.4	5.1		6.2	5		6.2	4.9		120
125	6.6	5.1		6.2	4.9		6.3	5		6.1	4.9		6	4.8		125
130	6.4	5	4.1	6	4.8		6.1	4.9		5.9	4.8		5.9	4.7		130
135	6.2	4.9	4	5.9	4.7	3.9	6	4.7	3.9	5.8	4.6	3.8	5.8	4.6		135
140	6	4.8	3.9	5.7	4.6	3.8	5.8	4.6	3.9	5.6	4.5	3.8	5.6	4.5	3.8	140
145	5.9	4.7	3.9	5.6	4.5	3.8	5.7	4.6	3.8	5.5	4.5	3.7	5.5	4.5	3.7	145
150	5.7	4.6	3.8	5.5	4.4	3.7	5.5	4.5	3.7	5.4	4.4	3.7	5.4	4.4	3.7	150
155	5.5	4.5	3.8	5.3	4.3	3.7	5.4	4.4	3.7	5.3	4.3	3.6	5.2	4.3	3.6	155
160	5.4	4.4	3.7	5.2	4.2	3.6	5.3	4.3	3.7	5.2	4.2	3.6	5.1	4.2	3.6	160
165	5.3	4.3	3.7	5.1	4.2	3.6	5.1	4.2	3.6	5	4.1	3.6	5	4.1	3.5	165
170	5.1	4.2	3.6	5	4.1	3.6	5	4.1	3.6	4.9	4.1	3.5	4.9	4	3.5	170
175	5	4.1	3.6	4.8	4	3.5	4.9	4	3.5	4.8	4	3.5	4.8	4	3.5	175
180	4.9	4.1	3.6	4.7	3.9	3.5	4.8	4	3.5	4.7	3.9	3.5	4.7	3.9	3.5	180
185	4.7	4	3.5	4.6	3.9	3.5	4.7	3.9	3.5	4.6	3.8	3.5	4.6	3.9	3.4	185
190	4.6	3.9	3.5	4.5	3.8	3.5	4.6	3.9	3.5	4.5	3.8	3.4	4.5	3.8	3.4	190
195	4.5	3.9	3.5	4.4	3.8	3.5	4.5	3.8	3.5	4.4	3.8	3.4	4.4	3.7	3.4	195
200	4.4	3.8	3.5	4.3	3.7	3.5	4.4	3.7	3.4	4.3	3.7	3.4	4.3	3.7	3.4	200
205	4.3	3.7	3.5	4.3	3.7	3.5	4.3	3.7	3.4	4.2	3.7	3.4	4.2	3.6	3.4	205
210	4.2	3.7	3.5	4.2	3.6	3.5	4.2	3.6	3.4	4.2	3.6	3.4	4.1	3.6	3.4	210
215	4.1	3.6	3.5	4.1	3.6	3.5	4.1	3.6	3.4	4.1	3.6	3.4	4.1	3.6	3.4	215
220	4.1	3.6	3.5	4	3.6	3.5	4	3.6	3.4	4	3.5	3.4	4	3.5	3.4	220
225	4	3.5	3.5	3.9	3.5	3.5	4	3.5	3.4	3.9	3.5	3.4	3.9	3.5	3.4	225
230	3.9	3.5	3.5	3.8	3.5	3.5	3.9	3.5	3.4	3.9	3.5	3.4	3.8	3.5	3.4	230
235	3.8	3.5	3.5	3.8	3.5	3.5	3.8	3.5	3.4	3.8	3.4	3.4	3.8	3.4	3.4	235
240	3.7	3.5	3.5	3.7	3.4	3.5	3.8	3.4	3.4	3.7	3.4	3.4	3.7	3.4	3.4	240
245	3.7	3.5	3.5	3.7	3.4	3.5	3.7	3.4	3.4	3.7	3.4	3.4	3.7	3.4	3.4	245
250	3.6	3.5	3.5	3.6	3.4	3.5	3.6	3.4	3.4	3.6	3.4	3.4	3.6	3.4	3.4	250
255	3.6	3.5	3.5	3.6	3.4	3.5	3.6	3.4	3.4	3.6	3.4	3.4	3.6	3.4	3.4	255
260	3.5	3.5	3.5	3.5	3.4	3.5	3.5	3.4	3.4	3.5	3.4	3.4	3.5	3.4	3.4	260
265	3.5	3.5		3.5	3.4	3.5	3.5	3.4	3.4	3.5	3.4	3.4	3.5	3.4	3.4	265
270	3.4	3.5		3.4	3.4	3.5	3.5	3.4	3.4	3.4	3.4	3.4	3.4	3.4	3.4	270
275	3.4			3.4			3.4	3.4	3.4	3.4	3.4	3.4	3.4	3.4	3.4	275
280				3.3			3.4	3.4		3.4	3.4	3.4	3.4	3.4	3.4	280
285				3.2			3.2			3.4	3.4		3.4	3.4		285
290										3.2			3.3			290
295										2.3			2.6			295

t\_259\_106\_16151 / 36151\_00\_000

# Lifting heights Hauteurs de levage

**TNZK**

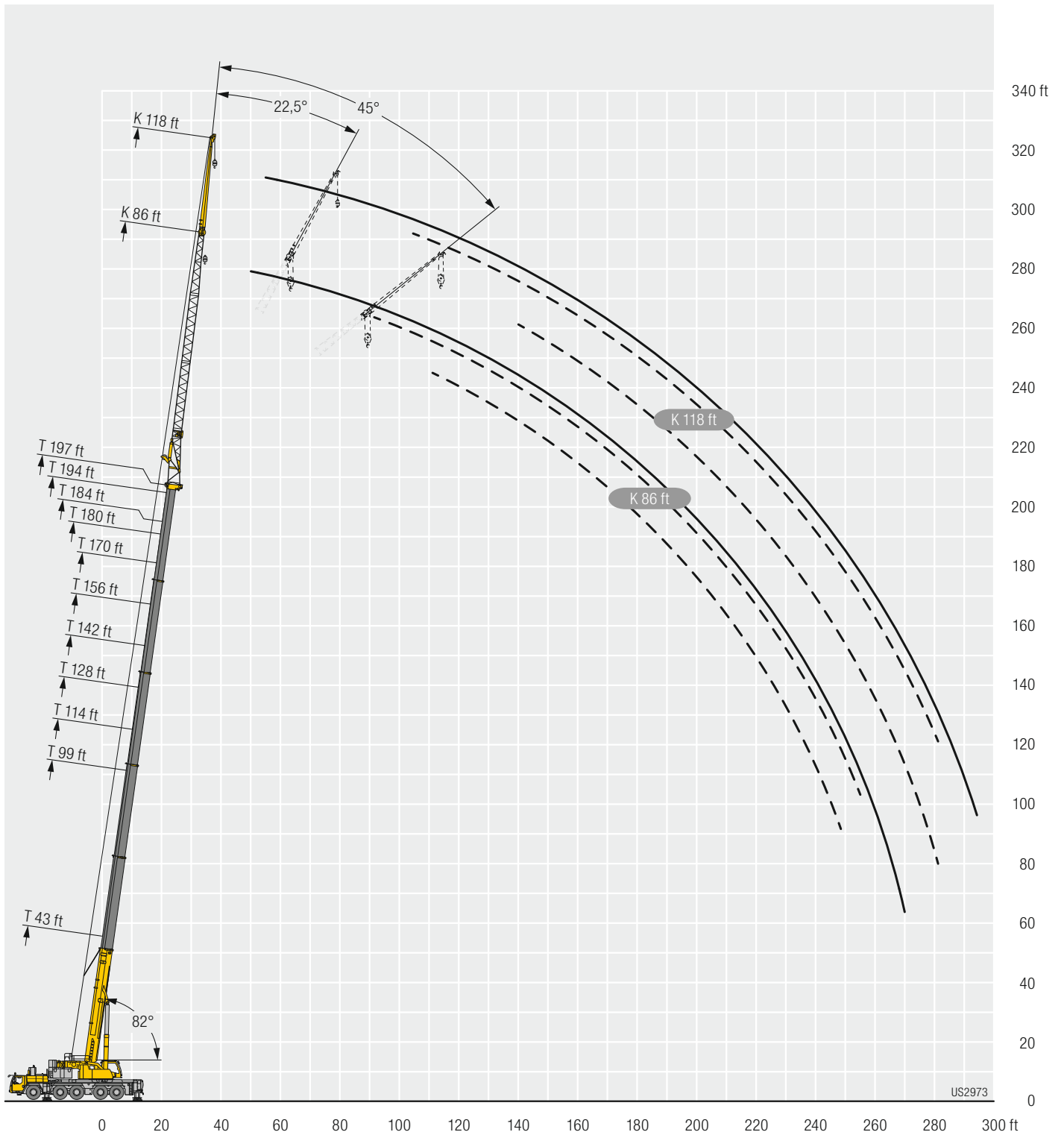

# Lifting capacities Forces de levage

TVNZK

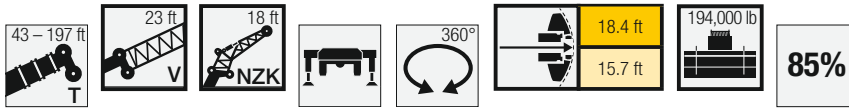

↙ ↘	43 ft + 23 ft			99 ft + 23 ft			114 ft + 23 ft			128 ft + 23 ft			142 ft + 23 ft			156 ft + 23 ft			↙ ↘
	18 ft																		
	0°	22,5°	45°	0°	22,5°	45°	0°	22,5°	45°	0°	22,5°	45°	0°	22,5°	45°	0°	22,5°	45°	
11	73.3																		11
12	73																		12
13	70.1																		13
14	67.3																		14
15	64.7																		15
16	62.2	63.3																	16
17	59.9	62.9																	17
18	57.9	61.5																	18
19	55.9	60																	19
20	54	58.5	56																20
22	50.5	55.3	54.2	71.9															22
24	47.1	52	51.4	68.5			68.1												24
26	44.2	48.9	48.4	65.3			65.4												26
28	41.4	46.1	45.6	62.4	61.8		62.7					61.3							28
30	38.9	43.6	42.9	59.7	60.1		60.3	59.6				59.1							30
32	36.7	41.2	40.6	57.2	58.3	54.7	58	58				57.1			54.3				32
34	34.7	39	38.5	54.9	56.4	53.2	55.9	56.3	52.3			55.2	53.9		53				34
36	33	37	36.3	52.8	54.5	51.6	53.9	54.6	50.9			53.4	52.7	48.4	51.5			48.2	36
38	31.3	35.1	34.5	50.7	52.6	49.9	52	52.9	49.5			51.8	51.3	47.4	50.1	48.2		47	38
40	29.7	33.5	32.8	48.7	50.7	48.1	50.3	51.3	48			50.2	49.9	46.3	48.7	47.1	43.1	45.9	40
45	26.5	29.8	29	44.1	46.4	44.2	46.2	47.4	44.5			46.6	46.6	43.4	45.6	44.5	41.1	43.3	45
50	23.7	26.5	25.9	40.1	42.8	40.7	42.5	43.9	41.4			43.4	43.6	40.7	42.8	42	38.9	41	50
55	21.5	23.7	23.2	36.8	39.4	37.6	39.1	40.9	38.6			40.4	40.9	38.2	40.3	39.7	36.8	38.9	55
60	19.5	21.3	21	33.9	36.6	34.9	36.2	38.1	36.1			37.6	38.4	35.9	37.9	37.5	34.9	36.9	60
65	17.9	19.2	19	31.5	34	32.4	33.6	35.7	33.7			35.1	36.2	34	35.7	35.5	33.2	35	65
70	16.5	17.5	13	29.2	31.7	30.3	31.4	33.4	31.6			32.8	34.1	32.1	33.5	33.8	31.5	33.2	70
75	15.4	16	5.9	27.3	29.6	28.3	29.4	31.5	29.8			30.9	32.2	30.3	31.6	32.1	30	31.5	75
80				25.4	27.8	26.6	27.6	29.7	28.1			29.1	30.5	28.7	29.9	30.6	28.6	29.9	80
85				24	26	24.9	26	28	26.5			27.5	29	27.3	28.3	29.2	27.3	28.5	85
90				22.5	24.3	23.5	24.5	26.5	25.1			26	27.5	25.9	26.9	27.9	26.1	27	90
95				21.3	22.9	22.2	23.2	25	23.8			24.7	26.2	24.7	25.5	26.6	24.9	25.9	95
100				20.1	21.5	21	22	23.7	22.6			23.4	25	23.5	24.4	25.5	23.8	24.8	100
105				19.1	20.3	19.9	20.9	22.4	21.5			22.3	23.8	22.5	23.3	24.4	22.9	23.7	105
110				18.1	19.2	18.9	19.9	21.2	20.5			21.3	22.7	21.5	22.3	23.4	22	22.7	110
115				17.3	18.3	17.6	19	20.2	19.6			20.4	21.7	20.5	21.4	22.5	21.1	21.9	115
120				16.5	17.4	12.7	18.2	19.2	18.7			19.5	20.7	19.7	20.5	21.7	20.3	21	120
125				15.8	16.5		17.4	18.3	17.9			18.7	19.8	18.9	19.7	20.8	19.5	20.3	125
130				15.2			16.7	17.5	14.5			18	19	18.2	19	20.1	18.8	19.6	130
135							16.1	16.8				17.3	18.2	17.5	18.3	19.3	18.2	18.9	135
140							15.5					16.7	17.5	16.2	17.7	18.6	17.6	18.3	140
145							15					16.1	16.9	12.6	17.1	17.9	17	17.7	145
150												15.6	16.3		16.5	17.3	16.5	17.1	150
155												15.1			16	16.8	13.9	16.7	155
160												13.9			15.6	16.2		16.2	160
165															15.1	15.8		15.8	165
170															14.7			15	170
175															13.1			14.7	175
180																		14.4	180
185																		13.2	185
190																		8.6	190

t\_259\_107\_10151 / 30151\_00\_000



# Lifting capacities Forces de levage

TVNZK

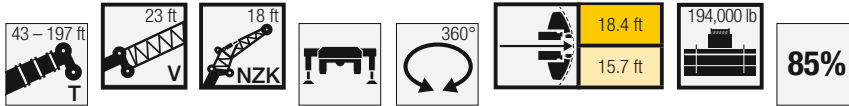

Jib ↙ ↘	170 ft + 23 ft			180 ft + 23 ft			184 ft + 23 ft			194 ft + 23 ft			197 ft + 23 ft			Jib ↙ ↘
	18 ft															
	0°	22,5°	45°	0°	22,5°	45°	0°	22,5°	45°	0°	22,5°	45°	0°	22,5°	45°	
40	40.4															40
45	38.9	36.2		33.2			34.1									45
50	37.1	35	32.3	32.6	30.4		33.4	30.8		29.9			29.3			50
55	35.5	33.7	31.1	31.7	29.5	27.3	32.4	29.9	27.7	29.4	27.6		28.9	27.1		55
60	34	32.5	30	30.6	28.6	26.5	31.2	29	26.9	28.9	26.9	24.9	28.4	26.5	24.5	60
65	32.6	31.2	28.9	29.3	27.7	25.7	30.1	28.2	26	28.3	26.2	24.2	27.9	25.9	23.9	65
70	31.1	30.1	27.8	28.1	26.8	24.9	28.9	27.3	25.3	27.4	25.5	23.6	27.2	25.2	23.3	70
75	29.7	29	26.8	27	26	24.1	27.7	26.5	24.5	26.4	24.8	23	26.3	24.6	22.7	75
80	28.4	27.9	25.9	25.9	25.2	23.4	26.6	25.7	23.8	25.5	24.2	22.4	25.4	23.9	22.1	80
85	27.2	26.9	25	25	24.4	22.7	25.6	24.9	23.1	24.6	23.5	21.8	24.5	23.3	21.6	85
90	26	26	24.1	24.1	23.7	22.1	24.7	24.2	22.4	23.8	22.9	21.2	23.7	22.7	21	90
95	25	25.1	23.3	23.2	23	21.4	23.8	23.5	21.7	23	22.3	20.7	22.9	22.2	20.5	95
100	24	24.2	22.5	22.5	22.3	20.8	23	22.8	21.1	22.3	21.8	20.1	22.2	21.6	20	100
105	23.1	23.4	21.8	21.7	21.7	20.2	22.2	22.1	20.5	21.6	21.2	19.6	21.5	21.1	19.5	105
110	22.3	22.7	21.1	21	21.1	19.7	21.5	21.5	20	21	20.7	19.1	20.9	20.6	19	110
115	21.5	22	20.4	20.4	20.4	19.1	20.8	20.9	19.4	20.3	20.2	18.7	20.3	20.1	18.5	115
120	20.8	21.3	19.8	19.7	19.8	18.6	20.2	20.4	18.9	19.7	19.6	18.2	19.7	19.6	18.1	120
125	20.1	20.6	19.2	19.1	19.1	18.1	19.6	19.8	18.4	19.1	19.1	17.8	19.1	19	17.7	125
130	19.4	20.1	18.7	18.4	18.4	17.7	19	19.3	17.9	18.5	18.4	17.4	18.5	18.4	17.3	130
135	18.8	19.5	18.1	17.7	17.7	17.2	18.5	18.8	17.5	17.9	17.8	17	17.9	17.8	16.9	135
140	18.3	18.9	17.6	17	17	16.8	18	18.4	17.1	17.3	17.2	16.6	17.2	17.2	16.5	140
145	17.7	18.5	17.2	16.3	16.3	16.3	17.5	17.9	16.7	16.7	16.7	16.2	16.6	16.7	16.2	145
150	17.2	18	16.7	15.7	15.7	15.8	17.1	17.5	16.3	16	16.1	15.9	16.1	16.1	15.8	150
155	16.8	17.5	16.3	15.1	15.1	15.2	16.6	17.1	15.9	15.5	15.5	15.5	15.5	15.5	15.5	155
160	16.3	17.1	15.9	14.5	14.5	14.6	16.2	16.8	15.6	14.9	15	15	15	15	15.1	160
165	15.9	16.6	15.5	14	14	14.1	15.9	16.3	15.3	14.4	14.5	14.5	14.5	14.5	14.6	165
170	15.3	15.6	15.2	13.5	13.5	13.6	15.5	15.9	14.9	13.9	14	14	14	14	14.1	170
175	14.9	15	14.6	13	13	13.1	14.9	15	14.7	13.5	13.5	13.6	13.5	13.5	13.6	175
180	14.5	14.5	13.3	12.5	12.6	12.7	13.9	14.1	14.1	13	13.1	13.2	13	13	13.1	180
185	14.1	14.1		12.1	12.1	12.2	13	13.2	13.2	12.6	12.6	12.7	12.5	12.5	12.6	185
190	13.3	13.4		11.7	11.7	11.8	12.2	12.3	12.3	12.1	12.2	12.3	11.9	12.1	12.1	190
195	12.4			11.3	11.3		11.4	11.5	11.5	11.4	11.6	11.5	11.2	11.4	11.4	195
200	9.8			10.9	10.9		10.7	10.8		10.7	10.8	10.8	10.5	10.6	10.6	200
205	4.7			10.5			10	10.1		10	10.1		9.8	9.9	9.9	205
210				8.2			8.9			9.3	9.4		9.1	9.2		210
215				3.4			6.3			8.7			8.5	8.6		215
220										7.5			7.8			220
225										5.2			6			225
230													3			230

t\_259\_107\_10151 / 30151\_00\_000

# Lifting capacities Forces de levage

TVNZK

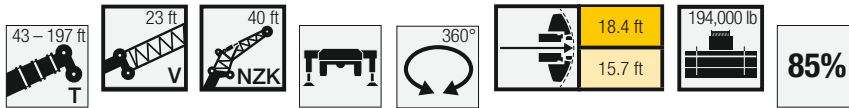

Jib Length	43 ft + 23 ft			99 ft + 23 ft			114 ft + 23 ft			128 ft + 23 ft			142 ft + 23 ft			156 ft + 23 ft			Jib Length
	0°	22.5°	45°	0°	22.5°	45°	0°	22.5°	45°	0°	22.5°	45°	0°	22.5°	45°	0°	22.5°	45°	
11	46.1																		11
12	46.1																		12
13	46.1																		13
14	46.1																		14
15	46.1																		15
16	46.1																		16
17	46.1																		17
18	46.1																		18
19	46.1																		19
20	45.9																		20
22	44.6			46.1															22
24	42.7			46.1			46.1												24
26	40.9	38.2		46.1			46.1												26
28	39.2	37.7		46.1			46.1			45.4									28
30	37.5	36.4		46.1			46.1			44.9									30
32	36.1	35.1		46.1			46			44.2			40.5						32
34	34.6	33.9		45.6			45.4			43.5			40.1						34
36	33.2	32.8		44.7			44.5			42.7			39.5			35.3			36
38	32	31.8	27.4	43.5	37.8		43.4			41.8			39			35			38
40	30.7	30.8	26.9	42.3	37		42.3	36.6		40.9			38.3			34.6			40
45	28.1	28.6	25.9	39.4	34.9		39.7	34.9		38.7	34		36.6			33.5			45
50	25.7	26.6	24.9	36.8	33.1	27.1	37.3	33.3		36.7	32.6		35	31.4		32.3			50
55	23.7	24.9	23.7	34.4	31.4	26.4	35.1	31.7	26.6	34.7	31.3	26.6	33.4	30.3		31.1	28.5		55
60	21.9	23.3	22.4	32.3	29.9	25.8	33.1	30.3	26	32.9	30	26	31.9	29.2	25.6	29.9	27.6		60
65	20.3	22	21	30.3	28.6	25.2	31.3	28.9	25.5	31.3	28.8	25.4	30.4	28.1	24.9	28.7	26.8	23.9	65
70	18.9	20.6	19.3	28.6	27.3	24.6	29.5	27.8	24.8	29.7	27.7	24.7	29.1	27.1	24.2	27.6	26	23.1	70
75	17.6	18.9	17.6	27	26.1	23.8	28	26.7	24	28.3	26.7	23.9	27.8	26.2	23.5	26.6	25.2	22.3	75
80	16.5	17.5	16.1	25.5	25	23	26.6	25.6	23.3	26.9	25.7	23.3	26.6	25.4	22.9	25.6	24.5	21.6	80
85	15.6	16.2	14.7	24.2	24	22.3	25.3	24.6	22.6	25.7	24.8	22.6	25.5	24.5	22.1	24.6	23.8	20.8	85
90	14.7	15	13.4	22.9	23.1	21.4	24	23.8	21.9	24.6	24	21.9	24.5	23.8	21.3	23.7	23.1	20.1	90
95	13.9	14	5.3	21.8	22.2	20.5	22.9	23	21.1	23.5	23.2	21	23.5	23.1	20.5	22.9	22.4	19.4	95
100	13.4			20.7	21.4	19.5	21.9	22.1	20.1	22.5	22.4	20.1	22.6	22.4	19.7	22.1	21.7	18.8	100
105				19.8	20.5	18.5	20.9	21.3	19.1	21.6	21.7	19.2	21.7	21.7	18.9	21.3	21	18.1	105
110				18.9	19.5	17.5	20	20.4	18.2	20.7	20.9	18.4	20.9	20.9	18.2	20.6	20.3	17.5	110
115				18.1	18.5	16.6	19.2	19.6	17.4	19.9	20.1	17.6	20.2	20.1	17.5	19.9	19.6	16.9	115
120				17.3	17.7	15.8	18.4	18.7	16.6	19.1	19.3	16.9	19.4	19.3	16.9	19.3	19	16.4	120
125				16.6	16.9	15	17.7	17.9	15.8	18.4	18.5	16.2	18.8	18.7	16.2	18.7	18.4	15.8	125
130				15.9	16.1	14.3	17	17.2	15.2	17.8	17.8	15.6	18.1	18	15.7	18.1	17.8	15.3	130
135				15.3	15.4		16.4	16.4	14.5	17.1	17.1	15	17.5	17.4	15.1	17.5	17.2	14.8	135
140				14.8	14.7		15.8	15.8	13.9	16.6	16.5	14.4	17	16.8	14.6	17	16.7	14.4	140
145				14.3	14.1		15.2	15.2	13.1	16	15.9	13.8	16.5	16.2	14.1	16.5	16.2	13.9	145
150				13.8	13.5		14.8	14.5		15.5	15.3	13.3	16	15.7	13.6	16.1	15.7	13.5	150
155				13.5			14.3	14		15	14.7	12.8	15.5	15.2	13.1	15.6	15.2	13.1	155
160							13.9	13.5		14.6	14.3	11.1	15.1	14.7	12.7	15.2	14.8	12.7	160
165							13.5	13.1		14.2	13.8		14.7	14.3	12.3	14.8	14.4	12.3	165
170							11.4			13.8	13.4		14.3	13.8	11.7	14.5	14	12	170
175										13.5	13		13.9	13.4		14.1	13.6	11.6	175
180										12.3	12.7		13.6	13.1		13.6	13.3	11.3	180
185										9.2			13.2	12.8		13.3	13	10.3	185
190													12.8	12.5		13.1	12.5		190
195													10.2			12.5	12.3		195
200																11.8	12		200
205																10.2	11.2		205
210																8.2			210

t\_259\_107\_11151 / 31151\_00\_000

# Lifting capacities Forces de levage

TVNZK

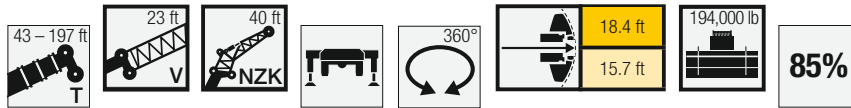

Jib Length (ft)	170 ft + 23 ft			180 ft + 23 ft			184 ft + 23 ft			194 ft + 23 ft			197 ft + 23 ft			Jib Length (ft)
	0°	22,5°	45°	0°	22,5°	45°	0°	22,5°	45°	0°	22,5°	45°	0°	22,5°	45°	
40	30.2															40
45	29.6			24.9			25.3			21						45
50	28.8			24.5			24.9			20.8			20.5			50
55	28			24			24.4			20.5			20.2			55
60	27.2	25.5		23.5			23.9			20.1			19.8			60
65	26.3	24.8		22.9	21.7		23.3	22.1		19.7	19.2		19.4	18.9		65
70	25.4	24.2	20.9	22.3	21.2		22.7	21.6		19.2	18.9		19	18.6		70
75	24.6	23.6	20.3	21.7	20.8	17.9	22.1	21.1	18.1	18.8	18.5	15.9	18.6	18.3	15.7	75
80	23.8	23.1	19.7	21.2	20.3	17.5	21.6	20.6	17.6	18.4	18.1	15.6	18.2	17.9	15.4	80
85	23.1	22.3	19.1	20.6	19.7	17	21	20.1	17.2	18	17.8	15.3	17.8	17.6	15.1	85
90	22.4	21.7	18.6	20.1	19	16.6	20.5	19.6	16.8	17.6	17.4	14.9	17.4	17.2	14.8	90
95	21.7	21	18	19.5	18.5	16.2	19.9	19.1	16.4	17.2	17	14.6	17	16.8	14.4	95
100	21	20.4	17.5	19	17.9	15.8	19.4	18.6	15.9	16.8	16.7	14.3	16.6	16.5	14.1	100
105	20.4	19.8	16.9	18.5	17.4	15.4	18.9	18.1	15.5	16.4	16.3	14	16.3	16.1	13.8	105
110	19.8	19.2	16.5	18	17	15	18.4	17.6	15.1	16	16	13.7	15.9	15.8	13.5	110
115	19.2	18.6	16	17.5	16.5	14.6	17.9	17.1	14.8	15.7	15.6	13.4	15.6	15.5	13.2	115
120	18.6	18.1	15.5	17	16	14.2	17.5	16.7	14.4	15.4	15.3	13.1	15.3	15.1	12.9	120
125	18.1	17.6	15.1	16.4	15.6	13.9	17.1	16.2	14	15	14.9	12.8	14.9	14.8	12.7	125
130	17.6	17.1	14.6	15.9	15.2	13.6	16.7	15.8	13.7	14.7	14.6	12.5	14.6	14.5	12.4	130
135	17.1	16.6	14.2	15.4	14.7	13.2	16.3	15.5	13.4	14.4	14.3	12.2	14.3	14.2	12.1	135
140	16.7	16.2	13.8	14.8	14.3	12.9	15.9	15.1	13	14.1	13.9	12	14	13.8	11.9	140
145	16.2	15.7	13.5	14.3	13.9	12.6	15.4	14.8	12.7	13.8	13.6	11.7	13.7	13.5	11.6	145
150	15.8	15.3	13.1	13.8	13.5	12.3	15	14.4	12.4	13.5	13.2	11.5	13.4	13.2	11.4	150
155	15.4	14.9	12.7	13.3	13.1	12	14.6	14.1	12.1	13.1	12.9	11.2	13.1	12.8	11.2	155
160	15.1	14.5	12.4	12.8	12.8	11.7	14.2	13.7	11.9	12.7	12.5	11	12.7	12.5	10.9	160
165	14.7	14.2	12.1	12.3	12.4	11.5	13.8	13.4	11.6	12.4	12.2	10.8	12.3	12.2	10.7	165
170	14.4	13.9	11.8	11.9	12	11.2	13.4	13.1	11.3	12	11.9	10.6	12	11.9	10.5	170
175	14.1	13.5	11.5	11.4	11.5	11	13.1	12.8	11.1	11.6	11.6	10.4	11.6	11.6	10.3	175
180	13.7	13.2	11.2	11	11.1	10.8	12.7	12.5	10.9	11.2	11.3	10.2	11.2	11.3	10.2	180
185	12.9	12.9	11	10.6	10.7	10.6	12.3	12.2	10.7	10.8	10.9	10	10.8	10.9	10	185
190	12.1	12.6	10.7	10.2	10.3	10.4	12	11.9	10.5	10.5	10.5	9.8	10.5	10.6	9.8	190
195	11.3	11.8	10.5	9.8	9.9	10.1	11.6	11.6	10.3	10.1	10.2	9.7	10.1	10.2	9.6	195
200	11	11.1		9.5	9.6	9.8	10.9	11.3	10.1	9.8	9.9	9.5	9.8	9.9	9.5	200
205	10.6	10.8		9.2	9.3	9.4	10.2	10.6	9.9	9.5	9.5	9.4	9.5	9.6	9.3	205
210	10.4	10.5		8.9	8.9	8.2	9.5	9.9	9.4	9.2	9.2	9.2	9.2	9.3	9.2	210
215	10	10.3		8.6	8.7		8.9	9.3	7.7	8.8	9	9.1	8.8	9	9	215
220	8	9.1		8.3	8.4		8.3	8.6		8.4	8.7	8.8	8.2	8.6	8.7	220
225	5.3			8	8.1		7.8	8		7.8	8.2		7.7	8	7.9	225
230				6.8			7	7.5		7.3	7.6		7.2	7.5		230
235				4.3			5.2			6.9	7.1		6.8	7		235
240							2.3			6.1	6.7		6.3	6.5		240
245										4.4			4.9			245
250													2.7			250

t\_259\_107\_11151 / 31151\_00\_000

# Lifting capacities Forces de levage

TVNZK

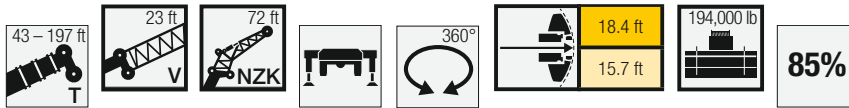

↙ ↘	43 ft + 23 ft			99 ft + 23 ft			114 ft + 23 ft			128 ft + 23 ft			142 ft + 23 ft			156 ft + 23 ft			↙ ↘
	72 ft																		
	0°	22,5°	45°	0°	22,5°	45°	0°	22,5°	45°	0°	22,5°	45°	0°	22,5°	45°	0°	22,5°	45°	
16	19.2																		16
17	19.2																		17
18	19.2																		18
19	19.2																		19
20	19.2																		20
22	19.2																		22
24	19.2																		24
26	19.1			19.2															26
28	19			19.2			18.7												28
30	18.8			19.2			18.7												30
32	18.6			19.2			18.7			18									32
34	18.4			19.2			18.7			18									34
36	18.2			19.2			18.7			18			17.1						36
38	17.9			19.1			18.6			17.9			17.1			15.9			38
40	17.7			19.1			18.6			17.9			17			15.9			40
45	17.1	15.3		18.8			18.5			17.8			16.9			15.8			45
50	16.5	14.7		18.4			18.2			17.7			16.8			15.7			50
55	15.9	14		18	15.3		17.8			17.4			16.7			15.7			55
60	15.3	13.5		17.6	14.9		17.4	14.9		17.1			16.6			15.6			60
65	14.7	13	11.1	17.1	14.4		17.1	14.5		16.8	14.3		16.3	14.1		15.5			65
70	14.1	12.5	10.8	16.7	14		16.7	14		16.4	14		16	13.7		15.3	13.4		70
75	13.5	12	10.6	16.3	13.6	11.1	16.3	13.7		16.1	13.6		15.7	13.4		15	13.1		75
80	13	11.6	10.3	15.9	13.3	10.9	15.9	13.3	10.9	15.7	13.3	10.8	15.4	13.1		14.8	12.8		80
85	12.4	11.3	10.1	15.4	12.9	10.7	15.5	13	10.7	15.4	13	10.7	15.1	12.8	10.6	14.5	12.6		85
90	11.9	10.9	10	15	12.6	10.6	15.1	12.7	10.6	15.1	12.7	10.5	14.8	12.5	10.5	14.3	12.3	10.3	90
95	11.5	10.6	9.9	14.6	12.3	10.4	14.8	12.4	10.4	14.7	12.4	10.4	14.5	12.3	10.3	14	12.1	10.2	95
100	11.1	10.4	9.8	14.2	12	10.3	14.4	12.1	10.3	14.4	12.1	10.3	14.2	12	10.2	13.8	11.8	10.1	100
105	10.7	10.2	9.8	13.8	11.7	10.2	14	11.8	10.2	14.1	11.9	10.2	13.9	11.8	10.1	13.5	11.6	10	105
110	10.3	10	9.8	13.3	11.4	10.1	13.6	11.6	10.1	13.7	11.6	10.1	13.6	11.6	10	13.2	11.4	9.9	110
115	9.9	9.9	9.8	13	11.2	10	13.3	11.3	10	13.4	11.4	10	13.3	11.4	9.9	13	11.2	9.8	115
120	9.6	9.8	9.8	12.6	11	9.9	12.9	11.1	9.9	13.1	11.2	9.9	13	11.2	9.8	12.7	11	9.7	120
125	9.2	9.7		12.2	10.8	9.9	12.6	10.9	9.9	12.8	11	9.8	12.7	11	9.8	12.4	10.9	9.7	125
130	9	9.5		11.9	10.6	9.8	12.3	10.7	9.8	12.4	10.8	9.8	12.5	10.8	9.7	12.2	10.7	9.6	130
135				11.6	10.4	9.8	11.9	10.6	9.8	12.1	10.6	9.7	12.2	10.6	9.7	11.9	10.6	9.6	135
140				11.3	10.2	9.8	11.6	10.4	9.8	11.8	10.5	9.7	11.9	10.5	9.6	11.7	10.4	9.6	140
145				11	10.1	9.8	11.4	10.3	9.8	11.6	10.3	9.7	11.7	10.3	9.6	11.4	10.3	9.5	145
150				10.7	10	9.8	11.1	10.1	9.8	11.3	10.2	9.7	11.4	10.2	9.6	11.2	10.1	9.5	150
155				10.5	9.9	9.8	10.8	10	9.8	11	10.1	9.7	11.2	10.1	9.6	10.9	10	9.5	155
160				10.2	9.9	9.8	10.6	9.9	9.8	10.8	10	9.7	10.9	10	9.6	10.7	9.9	9.5	160
165				9.9	9.8	9.8	10.3	9.9	9.8	10.6	9.9	9.7	10.7	9.9	9.6	10.5	9.8	9.5	165
170				9.6	9.8		10	9.8	9.8	10.3	9.8	9.7	10.5	9.8	9.6	10.3	9.7	9.5	170
175				9.4	9.7		9.8	9.8	9.7	10.1	9.7	9.7	10.2	9.7	9.6	10.1	9.6	9.4	175
180				9.2	9.5		9.5	9.7	9.3	9.8	9.7	9.6	10	9.7	9.5	9.9	9.6	9.3	180
185				9	9.5		9.3	9.5		9.6	9.6	9.3	9.8	9.6	9.3	9.7	9.5	9.1	185
190							9.1	9.4		9.4	9.5		9.5	9.6	9	9.5	9.5	8.8	190
195							9	9.4		9.2	9.4		9.3	9.4	8.7	9.3	9.4	8.6	195
200							8.9			9	9.3		9.2	9.3	8.5	9.2	9.3	8.4	200
205										8.9	9.2		9	9.2		9	9.2	8.2	205
210										8.8	9.2		8.8	9.1		8.9	9.1	7.9	210
215										7.1			8.7	9.1		8.7	9	7.7	215
220													8.6	9.1		8.6	8.9		220
225													7.6			8.4	8.9		225
230													6.1			8.3	8.8		230
235																7.8	8.7		235
240																6.7			240
245																3.3			245

t\_259\_107\_13151 / 33151\_00\_000

# Lifting capacities Forces de levage

TVNZK

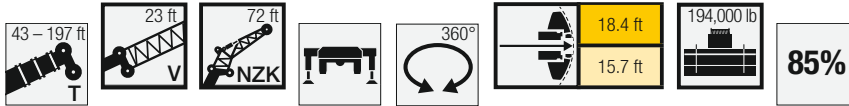

Jib Length	170 ft + 23 ft			180 ft + 23 ft			184 ft + 23 ft			194 ft + 23 ft			197 ft + 23 ft			Jib Length
	0°	22,5°	45°	0°	22,5°	45°	0°	22,5°	45°	0°	22,5°	45°	0°	22,5°	45°	
45	14.4															45
50	14.4			12.6			12.8			11.8						50
55	14.3			12.6			12.7			11.7			11.6			55
60	14.3			12.6			12.7			11.7			11.5			60
65	14.2			12.5			12.7			11.7			11.5			65
70	14.2			12.5			12.6			11.7			11.5			70
75	14.1	12.6		12.5			12.6			11.6			11.5			75
80	13.9	12.3		12.4	11.5		12.5	11.6		11.6			11.4			80
85	13.7	12.1		12.3	11.4		12.4	11.5		11.6	10.9		11.4	10.9		85
90	13.4	11.9		12	11.2		12.2	11.3		11.4	10.8		11.3	10.8		90
95	13.2	11.7	10	11.9	11		12	11.1		11.3	10.7		11.1	10.6		95
100	12.9	11.5	9.9	11.7	10.9	9.6	11.8	11	9.6	11.1	10.6		11	10.5		100
105	12.7	11.3	9.8	11.5	10.7	9.5	11.6	10.8	9.6	10.9	10.4	9.4	10.8	10.4	9.3	105
110	12.4	11.1	9.7	11.3	10.6	9.5	11.4	10.7	9.5	10.7	10.3	9.3	10.7	10.2	9.3	110
115	12.2	10.9	9.7	11.1	10.4	9.4	11.2	10.5	9.4	10.6	10.2	9.3	10.5	10.1	9.2	115
120	12	10.8	9.6	10.9	10.3	9.4	11	10.4	9.4	10.4	10.1	9.2	10.3	10	9.2	120
125	11.8	10.6	9.6	10.7	10.2	9.3	10.9	10.2	9.4	10.3	10	9.2	10.2	9.9	9.1	125
130	11.5	10.5	9.5	10.5	10	9.3	10.7	10.1	9.3	10.1	9.8	9.1	10	9.8	9	130
135	11.3	10.3	9.4	10.4	9.9	9.3	10.5	10	9.3	10	9.7	9	9.9	9.7	8.9	135
140	11.1	10.2	9.4	10.2	9.7	9.2	10.3	9.9	9.2	9.8	9.5	8.9	9.7	9.5	8.7	140
145	10.9	10.1	9.4	10	9.5	9	10.2	9.7	9.2	9.7	9.4	8.7	9.6	9.3	8.6	145
150	10.7	10	9.4	9.8	9.3	8.9	10	9.5	9.1	9.5	9.2	8.6	9.4	9.2	8.5	150
155	10.5	9.9	9.4	9.7	9.1	8.7	9.8	9.4	9	9.4	9	8.4	9.3	9	8.3	155
160	10.3	9.8	9.3	9.5	8.9	8.5	9.6	9.2	8.8	9.2	8.8	8.3	9.2	8.8	8.2	160
165	10.1	9.7	9.2	9.3	8.7	8.4	9.5	9	8.6	9.1	8.6	8.1	9	8.6	8	165
170	9.9	9.6	9.1	9.2	8.4	8.3	9.3	8.8	8.5	8.9	8.5	8	8.9	8.5	7.9	170
175	9.8	9.5	9	9	8.2	8.1	9.2	8.6	8.3	8.8	8.3	7.8	8.7	8.3	7.8	175
180	9.6	9.5	8.8	8.8	8.1	8	9	8.4	8.2	8.7	8.1	7.7	8.6	8.1	7.6	180
185	9.4	9.4	8.6	8.6	7.9	7.9	8.9	8.3	8	8.5	8	7.6	8.5	8	7.5	185
190	9.3	9.3	8.4	8.4	7.8	7.7	8.7	8.1	7.8	8.4	7.8	7.4	8.4	7.8	7.4	190
195	9.1	9.2	8.2	8.1	7.7	7.6	8.5	8	7.7	8.2	7.7	7.3	8.2	7.7	7.2	195
200	9	9.1	8	7.9	7.5	7.5	8.4	7.8	7.5	8.1	7.6	7.2	8.1	7.6	7.1	200
205	8.8	9	7.9	7.8	7.4	7.3	8.2	7.7	7.4	7.9	7.5	7.1	7.9	7.5	7	205
210	8.7	8.9	7.7	7.6	7.3	7.2	8	7.6	7.3	7.7	7.4	7	7.7	7.4	6.9	210
215	8.6	8.8	7.5	7.3	7.2	7.1	7.9	7.5	7.2	7.5	7.3	6.9	7.5	7.3	6.8	215
220	8.5	8.7	7.4	7.1	7.1	7	7.7	7.4	7.1	7.3	7.2	6.8	7.3	7.2	6.8	220
225	8.4	8.7	7.3	6.9	7	6.9	7.6	7.3	6.9	7.1	7.1	6.7	7.1	7.1	6.7	225
230	7.8	8.4	7.1	6.7	6.9	6.8	7.5	7.2	6.8	6.9	7	6.6	6.9	7	6.6	230
235	7.4	7.9		6.5	6.7	6.8	7.3	7.2	6.8	6.7	6.9	6.5	6.8	6.9	6.5	235
240	7.1	7.3		6.3	6.5		7.1	7.2	6.7	6.5	6.7	6.5	6.6	6.7	6.4	240
245	7	7.2		6.2	6.3		6.7	7	6.6	6.4	6.5	6.4	6.4	6.6	6.4	245
250	6.3			6	6.1		6.3	6.7		6.1	6.4	6.4	6	6.4	6.3	250
255	4.4			5.8	6		5.9	6.3		5.8	6.2		5.7	6.1		255
260				5.3			5.2	5.8		5.4	5.8		5.3	5.7		260
265				3.4			3.9	5		5.1	5.4		5	5.3		265
270										4.4	5		4.5	4.9		270
275										2.9			3.3			275

t\_259\_107\_13151 / 33151\_00\_000

# Lifting heights Hauteurs de levage

TVNZK

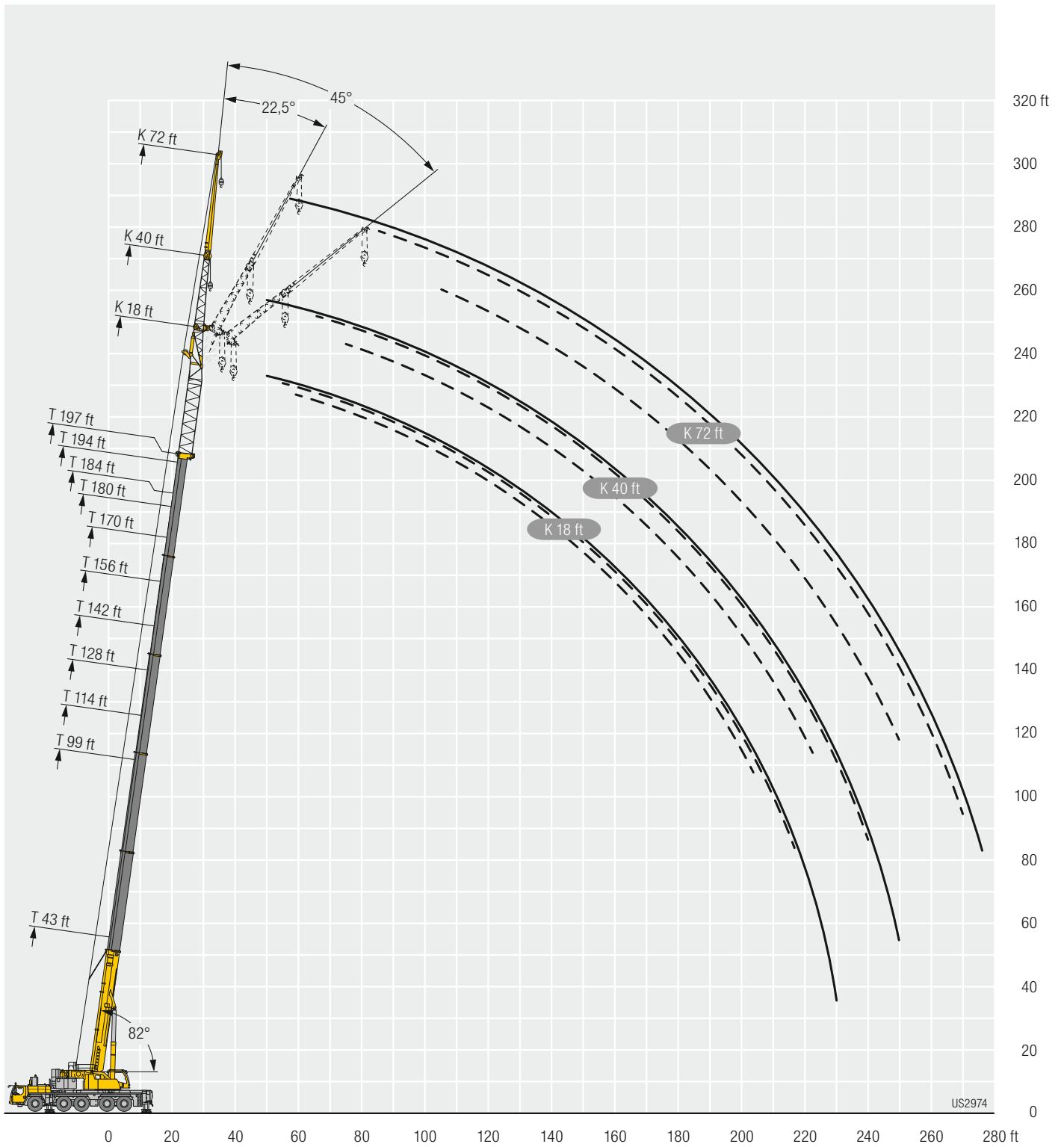



# Lifting capacities Forces de levage

TVNZK

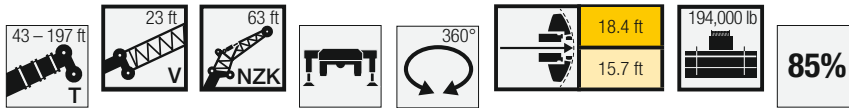

Jib height (ft)	43 ft + 23 ft			99 ft + 23 ft			114 ft + 23 ft			128 ft + 23 ft			142 ft + 23 ft			156 ft + 23 ft			Jib height (ft)
	0°	22,5°	45°	0°	22,5°	45°	0°	22,5°	45°	0°	22,5°	45°	0°	22,5°	45°	0°	22,5°	45°	
16	32.4																		16
17	32.4																		17
18	32.4																		18
19	32.4																		19
20	32.4																		20
22	32.1																		22
24	31.7																		24
26	31.1			32.4															26
28	30.6			32.4															28
30	29.9			32.4			30.8												30
32	29.2			32.3			30.8			28.7									32
34	28.3			32.1			30.8			28.6									34
36	27.5			31.8			30.6			28.6			26.1						36
38	26.6			31.4			30.3			28.5			26.1			22.5			38
40	25.9	22.3		31			30			28.3			26			22.4			40
45	24	21.1		30			29.2			27.6			25.7			22.3			45
50	22.3	19.9		28.6			28.2			26.9			25.1			22.1			50
55	20.8	18.9		27.1	21.5		27.1	21.5		26.2			24.6			22			55
60	19.4	17.9	14.8	25.8	20.7		25.9	20.7		25.2	20.4		24			21.7			60
65	18.1	17	14.4	24.4	19.9		24.7	19.9		24.2	19.8		23.2	19.3		21.1	18.7		65
70	17	16.1	14	23.2	19.2	15	23.5	19.3	14.9	23.3	19.1		22.4	18.8		20.5	18.3		70
75	16	15.3	13.6	22.1	18.5	14.6	22.5	18.7	14.6	22.3	18.6	14.5	21.6	18.2		19.9	17.8		75
80	15.1	14.6	13.2	21	17.9	14.3	21.5	18.1	14.3	21.4	18	14.5	20.8	17.7	14.1	19.3	17.3		80
85	14.2	13.9	12.8	20.1	17.2	14.1	20.5	17.5	14.1	20.5	17.4	14	20.1	17.2	14	18.7	16.8	14.7	85
90	13.4	13.3	12.5	19.1	16.6	13.8	19.7	16.9	13.8	19.7	16.9	13.8	19.3	16.7	13.7	18.2	16.4	14.5	90
95	12.8	12.7	12.3	18.2	16	13.6	18.8	16.3	13.6	18.9	16.4	13.6	18.7	16.2	13.5	17.6	15.9	14.3	95
100	12.1	12.1	12.1	17.5	15.5	13.3	18	15.8	13.4	18.2	15.9	13.4	18	15.8	13.3	17.1	15.5	14	100
105	11.6	11.6	11.8	16.7	15	13.1	17.3	15.3	13.2	17.5	15.4	13.2	17.4	15.3	13.1	16.6	15.2	13.7	105
110	11	11.1	10.9	16	14.6	12.9	16.6	14.9	13	16.9	15	13	16.8	14.9	12.9	16.1	14.8	13.5	110
115	10.6	10.8	7.1	15.3	14.1	12.7	16	14.5	12.8	16.2	14.6	12.8	16.2	14.6	12.7	15.6	14.4	13.2	115
120	10.2	10.5		14.7	13.7	12.5	15.4	14	12.6	15.7	14.2	12.6	15.7	14.2	12.5	15.2	14	13	120
125				14.2	13.3	12.4	14.8	13.7	12.4	15.1	13.8	12.4	15.2	13.8	12.4	14.7	13.7	12.8	125
130				13.6	12.9	12.2	14.3	13.3	12.3	14.6	13.5	12.3	14.7	13.5	12.2	14.3	13.4	12.5	130
135				13.1	12.5	12.2	13.8	12.9	12.2	14.1	13.1	12.2	14.3	13.2	12.1	13.9	13.1	12.1	135
140				12.7	12.2	12	13.3	12.6	12	13.7	12.8	12.1	13.8	12.9	12	13.6	12.8	11.8	140
145				12.2	11.8	11.8	12.8	12.2	12	13.2	12.5	12	13.4	12.6	11.9	13.2	12.5	11.5	145
150				11.8	11.5	11.4	12.4	11.9	11.8	12.8	12.2	11.8	13	12.3	11.6	12.8	12.3	11.2	150
155				11.4	11.2	10.8	12	11.6	11.4	12.4	11.9	11.5	12.7	12	11.3	12.5	12.1	10.8	155
160				11.1	10.9		11.7	11.3	10.9	12.1	11.6	11.1	12.3	11.7	11	12.2	11.8	10.5	160
165				10.8	10.7		11.3	11.1	10.5	11.8	11.3	10.7	12	11.5	10.7	11.9	11.6	10.2	165
170				10.5	10.6		11	10.8		11.4	11.1	10.3	11.7	11.2	10.3	11.6	11.4	9.9	170
175				10.2	10.5		10.7	10.6		11.1	10.8	10	11.4	11	10	11.3	11.2	9.7	175
180				8.8			10.5	10.5		10.9	10.6		11.1	10.7	9.7	11.1	11	9.4	180
185							10.2	10.4		10.6	10.4		10.8	10.6	9.4	10.9	10.9	9.2	185
190							10	10.4		10.4	10.3		10.6	10.4	9.1	10.6	10.7	8.9	190
195										10.2	10.2		10.4	10.3		10.4	10.6	8.6	195
200										10	10.2		10.2	10.1		10.2	10.4	8.4	200
205											7.6		10	10.1		10	10.3	8.2	205
210													9.8	10		9.7	10.2	8	210
215													8.6	10		9.6	9.9		215
220													7.4			9.4	9.7		220
225																8.7	9.4		225
230																7.5	8		230
235																4.7			235

t\_259\_107\_12151 / 32151\_00\_000

# Lifting capacities Forces de levage

TVNZK

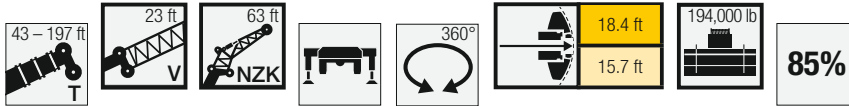

Jib height (ft)	170 ft + 23 ft			180 ft + 23 ft			184 ft + 23 ft			194 ft + 23 ft			197 ft + 23 ft			Jib height (ft)
	0°	22,5°	45°	0°	22,5°	45°	63 ft			0°	22,5°	45°	0°	22,5°	45°	
45	19.5															45
50	19.4			16.3			16.5			14.9						50
55	19.3			16.3			16.5			14.9			14.6			55
60	19.2			16.2			16.5			14.8			14.5			60
65	19			16.2			16.4			14.8			14.5			65
70	18.5	16.9		16			16.3			14.8			14.5			70
75	18.1	16.5		15.7	14.7		16			14.7			14.4			75
80	17.7	16.2		15.4	14.4		15.6	14.6		14.4	13.4		14.2	13.1		80
85	17.2	15.8		15.1	14.2		15.3	14.4		14.2	13.4		14	13.1		85
90	16.8	15.4	13.9	14.8	13.9		15	14.1		13.9	13.2		13.7	13		90
95	16.3	15	13.6	14.4	13.6	12	14.7	13.8	12.1	13.7	13		13.5	12.9		95
100	15.9	14.7	13.4	14.1	13.2	11.7	14.4	13.6	11.9	13.4	12.8	10.9	13.3	12.6	10.7	100
105	15.5	14.4	13.1	13.8	12.9	11.5	14.1	13.3	11.6	13.2	12.6	10.7	13	12.5	10.5	105
110	15.1	14.1	12.8	13.6	12.5	11.3	13.8	12.9	11.4	12.9	12.3	10.5	12.8	12.2	10.4	110
115	14.7	13.8	12.4	13.3	12.1	11	13.5	12.6	11.1	12.7	12	10.3	12.6	11.9	10.2	115
120	14.4	13.5	12.1	13	11.8	10.8	13.2	12.2	10.9	12.5	11.7	10.1	12.3	11.6	10	120
125	14	13.2	11.8	12.7	11.5	10.6	12.9	11.9	10.7	12.2	11.4	9.9	12.1	11.3	9.8	125
130	13.7	12.9	11.6	12.4	11.2	10.4	12.7	11.6	10.5	12	11.1	9.7	11.9	11.1	9.6	130
135	13.3	12.7	11.3	12.1	10.9	10.1	12.4	11.3	10.2	11.8	10.8	9.5	11.7	10.8	9.4	135
140	13	12.4	11	11.8	10.6	9.9	12.1	11	10	11.5	10.6	9.4	11.5	10.5	9.3	140
145	12.7	12.2	10.7	11.5	10.3	9.7	11.9	10.8	9.8	11.3	10.3	9.2	11.2	10.3	9.1	145
150	12.4	12	10.5	11.2	10.1	9.5	11.6	10.5	9.6	11	10.1	9	11	10.1	8.9	150
155	12.1	11.7	10.2	10.9	9.9	9.3	11.4	10.3	9.4	10.8	9.9	8.8	10.7	9.8	8.7	155
160	11.8	11.5	9.9	10.6	9.7	9.1	11.1	10.1	9.2	10.5	9.6	8.7	10.5	9.6	8.6	160
165	11.6	11.4	9.7	10.3	9.4	8.9	10.8	9.8	9	10.3	9.5	8.5	10.2	9.4	8.4	165
170	11.3	11.2	9.4	9.9	9.2	8.7	10.5	9.6	8.8	10	9.3	8.3	10	9.2	8.2	170
175	11.1	11	9.2	9.6	9	8.5	10.3	9.4	8.6	9.7	9.1	8.2	9.7	9.1	8.1	175
180	10.9	10.8	9	9.4	8.9	8.3	10	9.2	8.4	9.5	8.9	8	9.5	8.9	7.9	180
185	10.7	10.7	8.8	9.1	8.7	8.2	9.8	9	8.2	9.2	8.7	7.8	9.2	8.7	7.8	185
190	10.5	10.6	8.6	8.9	8.5	8	9.6	8.9	8.1	9	8.6	7.7	9	8.6	7.6	190
195	10.2	10.4	8.4	8.6	8.4	7.8	9.3	8.7	7.9	8.7	8.4	7.6	8.7	8.4	7.5	195
200	10.1	10.3	8.2	8.3	8.2	7.7	9.1	8.6	7.7	8.5	8.3	7.5	8.5	8.3	7.4	200
205	9.9	10.1	8	8	8	7.5	8.9	8.4	7.6	8.2	8.1	7.3	8.2	8.1	7.3	205
210	9.7	10	7.8	7.7	7.8	7.4	8.7	8.3	7.5	8	7.9	7.2	8	7.9	7.2	210
215	9.2	9.7	7.6	7.5	7.6	7.3	8.5	8.2	7.3	7.7	7.8	7.1	7.7	7.8	7.1	215
220	8.6	9.1	7.5	7.2	7.4	7.2	8.3	8.1	7.2	7.5	7.6	7	7.5	7.6	7	220
225	8	8.5		7	7.2	7.1	8.1	8	7.1	7.3	7.4	6.9	7.3	7.4	6.9	225
230	7.8	7.9		6.8	6.9	7	7.6	7.9	7.1	7	7.2	6.8	7.1	7.2	6.8	230
235	7.6	7.7		6.6	6.7		7.2	7.6	7	6.9	7	6.8	6.9	7	6.7	235
240	7.1	7.6		6.4	6.6		6.8	7.2		6.6	6.8	6.7	6.5	6.8	6.7	240
245	5.2			6.2			6.4	6.7		6.3	6.6	6.6	6.1	6.6	6.6	245
250				5.9			5.9	6.2		5.9	6.2		5.7	6.1		250
255				4.2			4.6	5.6		5.5	5.8		5.4	5.7		255
260							2.6			4.9			5			260
265										3.6			4			265
270													2.3			270

t\_259\_107\_12151 / 32151\_00\_000

# Lifting capacities Forces de levage

TVNZK

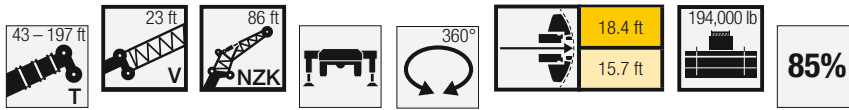

Lifting height (ft)	43 ft + 23 ft			99 ft + 23 ft			114 ft + 23 ft			128 ft + 23 ft			142 ft + 23 ft			156 ft + 23 ft			Lifting height (ft)
	0°	22.5°	45°	0°	22.5°	45°	0°	22.5°	45°	0°	22.5°	45°	0°	22.5°	45°	0°	22.5°	45°	
19	20.4																		19
20	20.4																		20
22	20.4																		22
24	20.3																		24
26	20.2																		26
28	20.1																		28
30	19.9			20.4															30
32	19.8			20.4			19.5												32
34	19.6			20.3			19.4												34
36	19.4			20.2			19.3			18.2									36
38	19			20.1			19.2			18.1			16.7						38
40	18.7			20.1			19.2			18			16.7						40
45	17.8			19.8			19			17.8			16.6			15			45
50	17			19.5			18.8			17.7			16.4			14.9			50
55	16.1	13.1		18.9			18.5			17.5			16.3			14.8			55
60	15.2	12.4		18.3			18			17.3			16.1			14.7			60
65	14.3	11.7		17.6	13.3		17.5			16.9			16			14.6			65
70	13.5	11.1		17	12.7		16.9	12.7		16.4	12.6		15.6			14.5			70
75	12.7	10.6	8.7	16.4	12.2		16.3	12.3		16	12.2		15.3	11.9		14.2			75
80	12	10.1	8.4	15.7	11.8		15.8	11.8		15.5	11.8		14.9	11.5		14	11.2		80
85	11.3	9.7	8.1	15	11.3		15.2	11.4		15	11.4		14.5	11.2		13.7	10.9		85
90	10.7	9.3	7.9	14.4	10.9	8.5	14.6	11.1	8.5	14.5	11		14.1	10.9		13.4	10.6		90
95	10.2	8.9	7.7	13.8	10.6	8.3	14.1	10.7	8.3	14	10.7	8.2	13.7	10.5		13.1	10.3		95
100	9.6	8.5	7.5	13.2	10.2	8.1	13.5	10.4	8.1	13.5	10.3	8.1	13.3	10.3	8	12.7	10	7.9	100
105	9.1	8.2	7.4	12.6	9.9	8	13	10	8	13.1	10.1	7.9	12.9	10	7.9	12.4	9.8	7.8	105
110	8.6	7.9	7.2	12.1	9.6	7.8	12.5	9.7	7.8	12.6	9.8	7.8	12.5	9.7	7.7	12.1	9.5	7.6	110
115	8.1	7.7	7.2	11.7	9.3	7.7	12	9.5	7.7	12.2	9.5	7.7	12.1	9.5	7.6	11.7	9.3	7.5	115
120	7.6	7.5	7.2	11.2	9	7.5	11.6	9.2	7.6	11.7	9.3	7.6	11.7	9.3	7.5	11.4	9.1	7.4	120
125	7.3	7.3	7.2	10.8	8.8	7.4	11.2	9	7.5	11.3	9	7.5	11.3	9	7.4	11.1	8.9	7.4	125
130	7	7.2	7.2	10.4	8.5	7.4	10.8	8.7	7.4	11	8.8	7.4	11	8.8	7.3	10.8	8.7	7.3	130
135	6.7	7.1	7.2	10	8.3	7.3	10.4	8.5	7.3	10.6	8.6	7.3	10.6	8.6	7.3	10.5	8.5	7.2	135
140	6.4	7.1		9.6	8.1	7.2	10	8.3	7.2	10.2	8.4	7.2	10.3	8.4	7.2	10.2	8.3	7.1	140
145	6.3			9.2	7.9	7.2	9.7	8.1	7.2	9.9	8.2	7.2	10	8.2	7.1	9.9	8.2	7.1	145
150				8.7	7.8	7.2	9.3	7.9	7.1	9.6	8	7.1	9.7	8.1	7.1	9.6	8	7	150
155				8.4	7.6	7.2	9	7.8	7.1	9.3	7.9	7.1	9.4	7.9	7.1	9.4	7.9	7	155
160				8	7.5	7.2	8.7	7.6	7.1	9	7.7	7.1	9.2	7.8	7	9.1	7.7	7	160
165				7.7	7.4	7.2	8.3	7.5	7.1	8.7	7.6	7	8.9	7.7	7	8.9	7.6	6.9	165
170				7.4	7.3	7.2	8	7.4	7.1	8.5	7.5	7	8.7	7.5	7	8.7	7.5	6.9	170
175				7.2	7.2	7.2	7.7	7.3	7.1	8.2	7.4	7	8.4	7.4	7	8.5	7.4	6.9	175
180				7	7.2	7.2	7.5	7.2	7.1	7.9	7.3	7	8.2	7.3	7	8.3	7.3	6.9	180
185				6.8	7.1		7.2	7.1	7.1	7.6	7.2	7	8	7.2	7	8.1	7.2	6.9	185
190				6.6	7.1		7	7.1	7.1	7.4	7.1	7	7.8	7.1	7	7.9	7.1	6.9	190
195				6.4	7.1		6.8	7.1		7.2	7.1	7	7.6	7.1	7	7.7	7	6.9	195
200				6.3			6.7	7.1		7	7	7	7.3	7	7	7.6	7	6.9	200
205							6.5	7.1		6.9	7		7.2	7	7	7.4	6.9	6.9	205
210							6.4	7.1		6.7	7		7	6.9	6.9	7.2	6.9	6.7	210
215							6.3			6.5	7		6.8	6.9		7.1	6.9	6.6	215
220										6.4	7		6.7	6.9		6.9	6.8	6.4	220
225										6.3	7		6.5	6.9		6.8	6.8	6.3	225
230										5.6			6.4	6.8		6.6	6.8	6.1	230
235													6.3	6.8		6.5	6.7		235
240													5.6			6.4	6.7		240
245													3.6			6.3	6.7		245
250																5.9	6.7		250
255																4.8			255

t\_259\_107\_14151 / 34151\_00\_000

# Lifting capacities Forces de levage

TVNZK

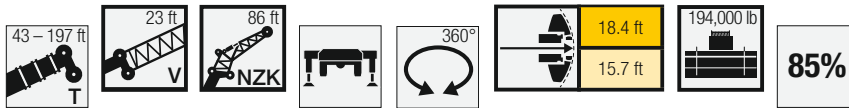

Lifting height (ft)	170 ft + 23 ft			180 ft + 23 ft			184 ft + 23 ft			194 ft + 23 ft			197 ft + 23 ft			Lifting height (ft)
	0°	22,5°	45°	0°	22,5°	45°	0°	22,5°	45°	0°	22,5°	45°	0°	22,5°	45°	
50	13.2			11.2												50
55	13.1			11.2			11.3			10.2			10			55
60	13.1			11.1			11.2			10.2			10			60
65	13			11.1			11.2			10.1			10			65
70	12.9			11			11.1			10.1			9.9			70
75	12.8			11			11.1			10.1			9.9			75
80	12.7			10.9			11.1			10			9.9			80
85	12.5	10.4		10.8			11			9.9			9.7			85
90	12.3	10.1		10.7	9.3		10.9	9.4		9.8			9.6			90
95	12.1	9.9		10.6	9.2		10.8	9.2		9.7	8.8		9.5	8.6		95
100	11.9	9.6		10.5	9		10.6	9.1		9.6	8.7		9.4	8.6		100
105	11.6	9.4	7.6	10.3	8.8		10.5	8.9		9.5	8.5		9.3	8.4		105
110	11.3	9.2	7.5	10.1	8.6		10.3	8.7		9.4	8.3		9.2	8.3		110
115	11.1	9	7.4	10	8.5	7.2	10.1	8.5	7.2	9.3	8.2		9.1	8.1		115
120	10.8	8.8	7.3	9.7	8.3	7.1	9.9	8.4	7.1	9.1	8	7	9.1	8	7	120
125	10.5	8.6	7.2	9.5	8.2	7	9.7	8.2	7.1	9	7.9	6.9	8.9	7.9	6.9	125
130	10.3	8.5	7.2	9.4	8	7	9.5	8.1	7	8.9	7.8	6.9	8.8	7.8	6.9	130
135	10	8.3	7.1	9.2	7.9	6.9	9.3	7.9	6.9	8.7	7.7	6.8	8.7	7.6	6.8	135
140	9.8	8.1	7.1	9	7.7	6.9	9.1	7.8	6.9	8.6	7.6	6.8	8.5	7.5	6.8	140
145	9.6	8	7	8.7	7.6	6.9	8.9	7.7	6.8	8.4	7.5	6.7	8.4	7.4	6.7	145
150	9.3	7.9	7	8.5	7.5	6.8	8.7	7.6	6.8	8.3	7.4	6.7	8.2	7.3	6.7	150
155	9.1	7.7	6.9	8.3	7.4	6.8	8.5	7.5	6.8	8.1	7.3	6.7	8	7.3	6.6	155
160	8.9	7.6	6.9	8.1	7.2	6.8	8.4	7.4	6.8	8	7.2	6.6	7.9	7.2	6.6	160
165	8.7	7.5	6.9	7.9	7.1	6.7	8.2	7.3	6.7	7.8	7.1	6.6	7.8	7.1	6.5	165
170	8.5	7.4	6.8	7.7	6.9	6.6	8	7.2	6.7	7.6	6.9	6.5	7.6	6.9	6.4	170
175	8.3	7.3	6.8	7.5	6.8	6.5	7.8	7	6.7	7.5	6.8	6.4	7.5	6.8	6.3	175
180	8.1	7.2	6.8	7.3	6.7	6.5	7.6	6.9	6.6	7.3	6.7	6.3	7.3	6.7	6.2	180
185	8	7.1	6.8	7.1	6.6	6.4	7.4	6.8	6.6	7.2	6.6	6.2	7.2	6.6	6.1	185
190	7.8	7.1	6.8	7	6.4	6.3	7.3	6.6	6.5	7	6.4	6.1	7	6.4	6	190
195	7.6	7	6.7	6.8	6.3	6.2	7.1	6.5	6.3	6.9	6.3	6	6.9	6.3	5.9	195
200	7.5	6.9	6.7	6.7	6.2	6.1	6.9	6.4	6.2	6.7	6.2	5.9	6.7	6.2	5.8	200
205	7.4	6.9	6.6	6.5	6.1	6.1	6.8	6.3	6.1	6.6	6.1	5.8	6.6	6.1	5.7	205
210	7.2	6.8	6.4	6.4	6	6	6.6	6.2	6	6.5	6	5.7	6.5	6	5.7	210
215	7.1	6.8	6.3	6.2	5.9	5.9	6.5	6.1	5.9	6.3	5.9	5.6	6.3	5.9	5.6	215
220	7	6.7	6.2	6.1	5.8	5.8	6.4	6	5.8	6.2	5.8	5.5	6.2	5.8	5.5	220
225	6.8	6.7	6.1	6	5.7	5.7	6.3	5.9	5.7	6.1	5.8	5.4	6.1	5.7	5.4	225
230	6.7	6.7	5.9	5.9	5.6	5.6	6.1	5.8	5.6	6	5.7	5.4	6	5.7	5.3	230
235	6.6	6.6	5.8	5.8	5.6	5.5	6	5.8	5.5	5.9	5.6	5.3	5.9	5.6	5.2	235
240	6.5	6.6	5.7	5.6	5.5	5.4	5.9	5.7	5.4	5.8	5.5	5.2	5.8	5.5	5.2	240
245	6.3	6.5	5.6	5.4	5.5	5.3	5.8	5.6	5.4	5.6	5.5	5.1	5.6	5.5	5.1	245
250	6	6.4		5.2	5.4	5.3	5.7	5.6	5.3	5.5	5.4	5.1	5.5	5.4	5	250
255	5.6	6		5.1	5.3	5.3	5.6	5.6	5.2	5.3	5.4	5	5.3	5.4	5	255
260	5.5	5.6		5	5.1		5.3	5.6		5.1	5.3	5	5.1	5.3	4.9	260
265	4.6	5.6		4.8	4.9		5	5.4		4.9	5.2		4.7	5.2	4.9	265
270	2.5			4.7	4.8		4.7	5		4.5	5		4.3	4.9		270
275				3.6			3.7	4.6		4.1	4.6		4	4.5		275
280										3.8	4.2		3.6			280
285										2.6	3.7		2.8			285

t\_259\_107\_14151 / 34151\_00\_000

# Lifting heights Hauteurs de levage

TVNZK

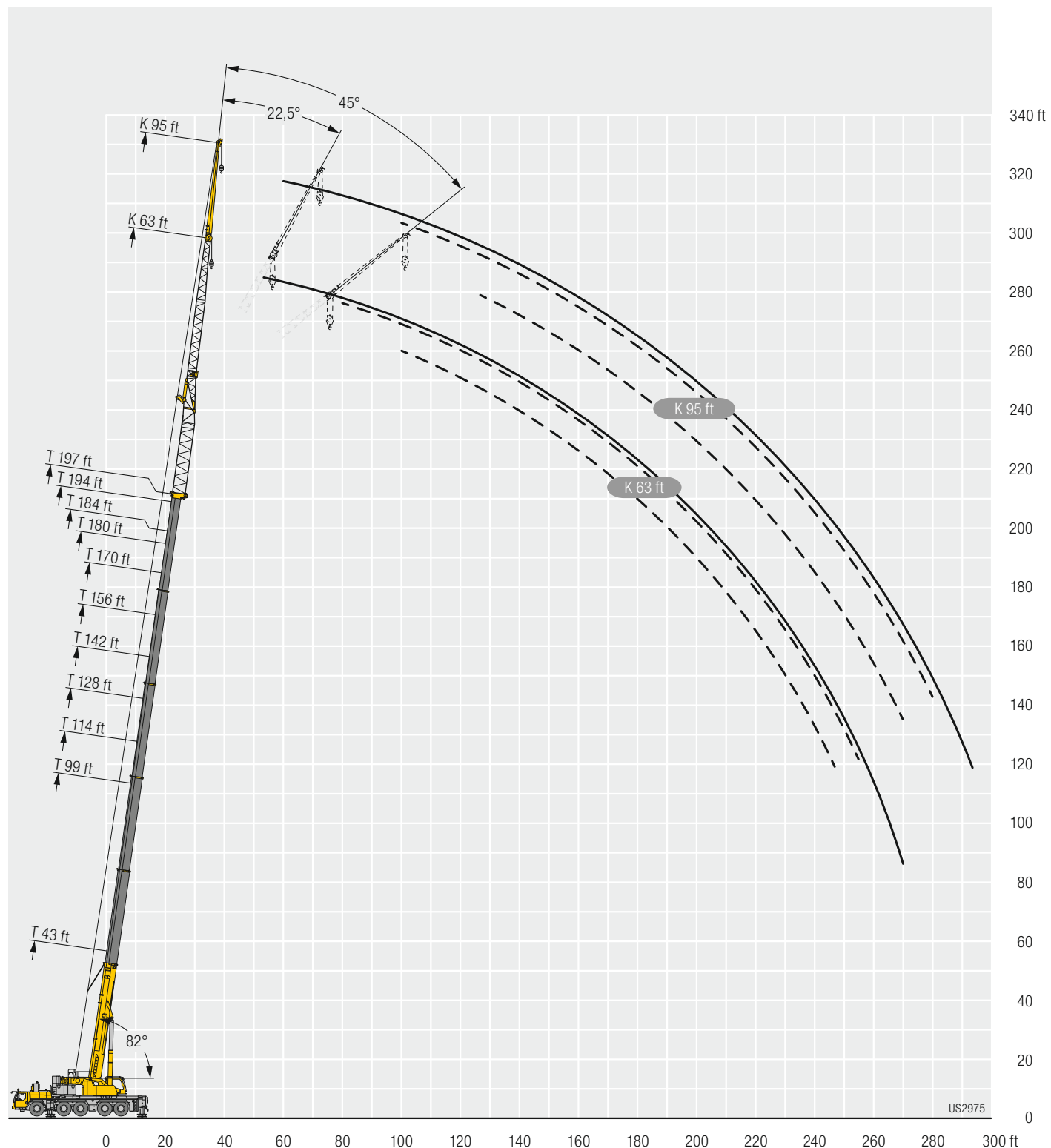

# Lifting capacities Forces de levage

TVNZK

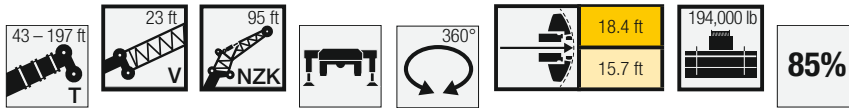

Jib Length	43 ft + 23 ft			99 ft + 23 ft			114 ft + 23 ft			128 ft + 23 ft			142 ft + 23 ft			156 ft + 23 ft			Jib Length
	0°	22.5°	45°	0°	22.5°	45°	0°	22.5°	45°	0°	22.5°	45°	0°	22.5°	45°	0°	22.5°	45°	
20	14.4																		20
22	14.4																		22
24	14.3																		24
26	14.3																		26
28	14.2																		28
30	14.2			14.4															30
32	14.1			14.4			13.9												32
34	14			14.4			13.9												34
36	14			14.3			13.9			13.3									36
38	13.9			14.3			13.8			13.2									38
40	13.9			14.2			13.8			13.2			12.5						40
45	13.7			14.1			13.7			13.1			12.4			11.6			45
50	13.3			14			13.6			13			12.3			11.5			50
55	12.8			13.9			13.5			12.9			12.3			11.4			55
60	12.2	10.5		13.8			13.4			12.9			12.2			11.3			60
65	11.6	10		13.6			13.3			12.7			12.1			11.3			65
70	11.1	9.5		13.3	10.6		13.1			12.6			12			11.2			70
75	10.6	9.1		12.9	10.2		12.8	10.2		12.5	10.1		11.9			11.1			75
80	10.1	8.7		12.4	9.8		12.5	9.9		12.3	9.8		11.8	9.6		11.1			80
85	9.6	8.3	7.1	12	9.5		12.1	9.6		11.9	9.5		11.6	9.3		11	9.1		85
90	9.1	8	6.9	11.6	9.2		11.7	9.2		11.6	9.2		11.3	9.1		10.8	8.8		90
95	8.7	7.6	6.7	11.2	8.9	7.1	11.3	9		11.3	8.9		11	8.8		10.6	8.6		95
100	8.3	7.4	6.5	10.8	8.6	6.9	11	8.7	6.9	10.9	8.7	6.9	10.7	8.6		10.3	8.4		100
105	7.9	7.2	6.4	10.4	8.4	6.8	10.6	8.4	6.8	10.6	8.5	6.8	10.4	8.3	6.7	10.1	8.2		105
110	7.6	7	6.3	10	8.1	6.7	10.3	8.2	6.7	10.3	8.2	6.7	10.1	8.1	6.6	9.8	8	6.6	110
115	7.3	6.7	6.2	9.7	7.9	6.6	9.9	8	6.6	10	8	6.6	9.9	8	6.5	9.6	7.8	6.5	115
120	7	6.6	6.1	9.4	7.6	6.5	9.6	7.8	6.5	9.7	7.8	6.5	9.6	7.8	6.5	9.3	7.6	6.4	120
125	6.8	6.4	6.1	9	7.5	6.4	9.3	7.6	6.4	9.4	7.6	6.4	9.3	7.6	6.4	9.1	7.5	6.3	125
130	6.5	6.3	6.1	8.7	7.3	6.3	9	7.4	6.3	9.1	7.4	6.4	9.1	7.4	6.3	8.9	7.3	6.3	130
135	6.2	6.2	6.1	8.4	7.1	6.3	8.7	7.2	6.3	8.8	7.3	6.3	8.8	7.3	6.2	8.7	7.2	6.2	135
140	6	6.1	6.1	8.1	7	6.2	8.4	7.1	6.2	8.6	7.1	6.2	8.6	7.1	6.2	8.4	7.1	6.1	140
145	5.8	6.1	6.1	7.9	6.8	6.2	8.2	6.9	6.2	8.3	7	6.2	8.3	7	6.1	8.2	6.9	6.1	145
150	5.6	6		7.6	6.7	6.1	7.9	6.8	6.1	8.1	6.9	6.1	8.1	6.9	6.1	8	6.8	6	150
155	5.5			7.4	6.6	6.1	7.7	6.7	6.1	7.8	6.7	6.1	7.9	6.8	6.1	7.8	6.7	6	155
160				7.2	6.5	6.1	7.5	6.6	6.1	7.6	6.6	6	7.7	6.7	6	7.7	6.6	5.9	160
165				7	6.4	6.1	7.3	6.5	6	7.4	6.5	6	7.5	6.6	6	7.5	6.5	5.9	165
170				6.8	6.3	6.1	7.1	6.4	6	7.3	6.4	6	7.3	6.5	5.9	7.3	6.4	5.9	170
175				6.6	6.2	6.1	6.9	6.3	6	7.1	6.3	6	7.2	6.4	5.9	7.2	6.3	5.9	175
180				6.4	6.2	6.1	6.8	6.2	6	6.9	6.3	6	7	6.3	5.9	7	6.3	5.9	180
185				6.2	6.1	6.1	6.6	6.2	6	6.8	6.2	6	6.9	6.2	5.9	6.9	6.2	5.9	185
190				6	6.1		6.4	6.1	6	6.6	6.1	6	6.7	6.1	5.9	6.8	6.1	5.9	190
195				5.8	6.1		6.2	6.1	6	6.5	6.1	6	6.6	6.1	5.9	6.6	6	5.9	195
200				5.7	6.1		6.1	6	6	6.4	6	6	6.5	6	5.9	6.5	6	5.9	200
205				5.6	6.1		5.9	6		6.2	6	6	6.4	6	5.9	6.4	5.9	5.9	205
210				5.5			5.8	6		6.1	6		6.3	5.9	5.9	6.3	5.9	5.9	210
215							5.6	6		5.9	6		6.1	5.9	5.9	6.2	5.9	5.9	215
220							5.5	6		5.8	6		6	5.9	5.9	6.1	5.8	5.9	220
225							5.5			5.7	6		6	5.9	5.9	6	5.8	5.9	225
230										5.6	6		5.8	5.9		5.9	5.8	5.9	230
235										5.5	6		5.7	5.9		5.8	5.8	5.9	235
240										4.7			5.6	5.9		5.7	5.8	5.8	240
245													5.5	5.9		5.7	5.8		245
250													5.1			5.5	5.8		250
255																5.5	5.8		255
260																5.1	5.8		260
265																4			265

t\_259\_107\_15151 / 35151\_00\_000



# Lifting capacities Forces de levage

TVNZK

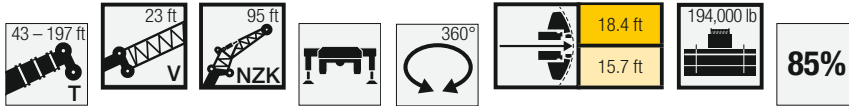

Jib Length	170 ft + 23 ft			180 ft + 23 ft			184 ft + 23 ft			194 ft + 23 ft			197 ft + 23 ft			Jib Length
	0°	22,5°	45°	0°	22,5°	45°	0°	22,5°	45°	0°	22,5°	45°	0°	22,5°	45°	
50	10.4															50
55	10.4			9			9.2			8.4						55
60	10.3			9			9.1			8.3			8.2			60
65	10.3			9			9.1			8.3			8.2			65
70	10.2			8.9			9			8.3			8.1			70
75	10.2			8.9			9			8.2			8.1			75
80	10.1			8.9			8.9			8.2			8.1			80
85	10			8.8			8.9			8.2			8.1			85
90	10	8.4		8.8			8.9			8.2			8			90
95	9.8	8.2		8.8	7.7		8.9	7.7		8.1			8			95
100	9.7	8		8.7	7.5		8.8	7.6		8.1	7.3		8	7.3		100
105	9.5	7.9		8.6	7.4		8.7	7.4		8	7.2		7.9	7.1		105
110	9.3	7.7		8.4	7.3		8.6	7.3		8	7.1		7.8	7.1		110
115	9.1	7.5	6.3	8.3	7.2		8.4	7.2		7.9	7		7.7	6.9		115
120	8.9	7.4	6.3	8.1	7.1	6.1	8.2	7.1	6.1	7.8	6.9		7.6	6.8		120
125	8.7	7.3	6.2	8	6.9	6	8.1	7	6.1	7.7	6.8	6	7.6	6.7	5.9	125
130	8.5	7.1	6.2	7.8	6.8	6	7.9	6.9	6	7.5	6.7	5.9	7.5	6.7	5.9	130
135	8.3	7	6.1	7.7	6.7	6	7.8	6.8	6	7.4	6.6	5.9	7.4	6.6	5.8	135
140	8.1	6.9	6	7.5	6.7	5.9	7.6	6.7	5.9	7.3	6.5	5.8	7.3	6.5	5.8	140
145	7.9	6.8	6	7.4	6.6	5.8	7.5	6.6	5.9	7.2	6.4	5.8	7.2	6.4	5.7	145
150	7.8	6.7	5.9	7.3	6.5	5.8	7.4	6.5	5.8	7.1	6.3	5.8	7.1	6.3	5.7	150
155	7.6	6.6	5.9	7.2	6.4	5.8	7.2	6.4	5.8	7	6.3	5.7	7	6.2	5.7	155
160	7.4	6.5	5.9	7.1	6.3	5.8	7.1	6.3	5.8	6.9	6.2	5.7	6.9	6.2	5.7	160
165	7.3	6.4	5.8	6.9	6.2	5.8	7	6.3	5.7	6.8	6.1	5.7	6.8	6.1	5.7	165
170	7.2	6.4	5.8	6.8	6.1	5.7	6.9	6.2	5.7	6.7	6.1	5.6	6.7	6	5.6	170
175	7	6.3	5.8	6.7	6.1	5.7	6.8	6.1	5.7	6.6	6	5.6	6.6	6	5.6	175
180	6.9	6.2	5.8	6.6	6	5.7	6.7	6	5.7	6.5	5.9	5.6	6.5	5.9	5.6	180
185	6.8	6.1	5.8	6.5	6	5.7	6.6	6	5.7	6.4	5.9	5.6	6.4	5.9	5.6	185
190	6.7	6.1	5.8	6.4	5.9	5.7	6.5	5.9	5.7	6.3	5.8	5.6	6.3	5.8	5.5	190
195	6.6	6	5.8	6.3	5.9	5.7	6.4	5.9	5.7	6.3	5.8	5.6	6.2	5.8	5.5	195
200	6.5	5.9	5.8	6.2	5.8	5.7	6.3	5.8	5.7	6.2	5.7	5.5	6.1	5.7	5.4	200
205	6.4	5.9	5.8	6.1	5.7	5.6	6.2	5.8	5.7	6.1	5.7	5.5	6.1	5.7	5.4	205
210	6.3	5.8	5.8	6	5.6	5.6	6.1	5.7	5.7	6	5.6	5.4	6	5.6	5.3	210
215	6.2	5.8	5.8	5.9	5.5	5.5	6.1	5.7	5.7	5.9	5.5	5.3	5.9	5.5	5.2	215
220	6.1	5.8	5.8	5.8	5.4	5.5	6	5.6	5.6	5.8	5.5	5.3	5.8	5.5	5.2	220
225	6	5.8	5.8	5.7	5.3	5.4	5.9	5.5	5.5	5.7	5.4	5.2	5.7	5.4	5.1	225
230	5.9	5.7	5.8	5.5	5.3	5.4	5.8	5.4	5.4	5.6	5.3	5.1	5.6	5.3	5.1	230
235	5.9	5.7	5.7	5.4	5.2	5.3	5.7	5.4	5.3	5.5	5.2	5.1	5.5	5.2	5	235
240	5.8	5.7	5.6	5.3	5.1	5.3	5.6	5.3	5.2	5.4	5.2	5	5.4	5.2	4.9	240
245	5.7	5.7	5.5	5.2	5.1	5.2	5.5	5.2	5.2	5.3	5.1	4.9	5.3	5.1	4.9	245
250	5.7	5.7	5.4	5.2	5	5.1	5.4	5.2	5.1	5.2	5	4.9	5.2	5.1	4.8	250
255	5.6	5.7		5	5	5	5.3	5.2	5.1	5.1	5	4.8	5.1	5	4.8	255
260	5.5	5.7		4.9	4.9	5	5.2	5.1	5	5	4.9	4.8	5	4.9	4.7	260
265	5.2	5.6		4.8	4.9		5.1	5.1	5	4.9	4.9	4.7	4.9	4.9	4.7	265
270	5	5.2		4.6	4.8		4.9	5.1		4.8	4.9	4.7	4.6	4.8	4.7	270
275	3.9			4.5	4.6		4.6	5		4.4	4.8		4.3	4.8		275
280				4.2	4.5		4.2	4.7		4.1	4.6		3.9	4.5		280
285				2.9			3	4.3		3.7	4.2		3.6			285
290										3.2	3.8		3.2			290
295													2.2			295

t\_259\_107\_15151 / 35151\_00\_000

# Lifting capacities Forces de levage

TVNZK

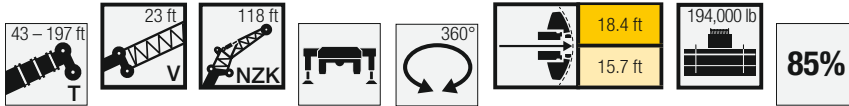

Jib ↙ ↘	43 ft + 23 ft			99 ft + 23 ft			114 ft + 23 ft			128 ft + 23 ft			142 ft + 23 ft			156 ft + 23 ft			Jib ↙ ↘
	118 ft																		
	0°	22,5°	45°	0°	22,5°	45°	0°	22,5°	45°	0°	22,5°	45°	0°	22,5°	45°	0°	22,5°	45°	
24	10.4																		24
26	10.4																		26
28	10.4																		28
30	10.3																		30
32	10.3																		32
34	10.2			10.3															34
36	10.2			10.3															36
38	10.1			10.3			10												38
40	10.1			10.3			10			9.5									40
45	9.9			10.2			9.9			9.5			8.9						45
50	9.7			10.1			9.8			9.4			8.8			8.1			50
55	9.3			10			9.7			9.3			8.8			8.1			55
60	8.9			9.9			9.6			9.2			8.7			8			60
65	8.5			9.8			9.6			9.1			8.6			8			65
70	8	6.8		9.6			9.4			9			8.5			7.9			70
75	7.6	6.6		9.2			9.2			8.9			8.4			7.8			75
80	7.3	6.3		8.9			8.9			8.7			8.4			7.8			80
85	7	6		8.6	6.7		8.6	6.7		8.5			8.2			7.7			85
90	6.7	5.8		8.2	6.5		8.3	6.5		8.2	6.4		8			7.6			90
95	6.4	5.5		7.9	6.2		8	6.3		7.9	6.2		7.7	6.1		7.4			95
100	6.1	5.3		7.6	6		7.7	6.1		7.7	6		7.5	6		7.2	5.8		100
105	5.8	5.1	4.4	7.4	5.9		7.5	5.9		7.4	5.9		7.3	5.8		7.1	5.6		105
110	5.6	4.9	4.3	7.1	5.7		7.2	5.7		7.2	5.7		7.1	5.6		6.9	5.5		110
115	5.3	4.8	4.2	6.9	5.5	4.4	7	5.6		7	5.5		6.9	5.5		6.7	5.4		115
120	5.1	4.6	4	6.6	5.4	4.3	6.8	5.4	4.3	6.8	5.4	4.3	6.7	5.4		6.5	5.2		120
125	4.9	4.5	4	6.4	5.2	4.2	6.5	5.3	4.2	6.6	5.3	4.2	6.5	5.2	4.2	6.4	5.1		125
130	4.7	4.3	3.9	6.2	5.1	4.2	6.3	5.1	4.2	6.4	5.1	4.1	6.4	5.1	4.1	6.2	5	4.1	130
135	4.6	4.2	3.8	6	4.9	4.1	6.1	5	4.1	6.2	5	4.1	6.2	5	4.1	6.1	4.9	4	135
140	4.4	4.1	3.8	5.8	4.8	4	5.9	4.9	4	6	4.9	4	6	4.9	4	5.9	4.8	3.9	140
145	4.2	4	3.7	5.6	4.7	4	5.8	4.7	4	5.8	4.8	4	5.8	4.7	3.9	5.8	4.7	3.9	145
150	4.1	3.9	3.7	5.4	4.6	3.9	5.6	4.6	3.9	5.7	4.7	3.9	5.7	4.6	3.9	5.6	4.6	3.8	150
155	4	3.8	3.7	5.2	4.4	3.9	5.4	4.5	3.9	5.5	4.5	3.9	5.5	4.5	3.8	5.5	4.5	3.8	155
160	3.8	3.7	3.7	5.1	4.4	3.8	5.3	4.4	3.8	5.3	4.5	3.8	5.4	4.4	3.8	5.3	4.4	3.7	160
165	3.7	3.7	3.7	4.9	4.3	3.8	5.1	4.3	3.8	5.2	4.4	3.8	5.2	4.4	3.7	5.2	4.3	3.7	165
170	3.5	3.7		4.8	4.2	3.7	4.9	4.2	3.7	5	4.3	3.7	5.1	4.3	3.7	5.1	4.2	3.7	170
175	3.4	3.7		4.6	4.1	3.7	4.8	4.2	3.7	4.9	4.2	3.7	5	4.2	3.7	4.9	4.2	3.6	175
180				4.5	4	3.7	4.7	4.1	3.7	4.8	4.1	3.7	4.8	4.1	3.6	4.8	4.1	3.6	180
185				4.4	3.9	3.7	4.5	4	3.7	4.6	4	3.6	4.7	4	3.6	4.7	4	3.6	185
190				4.3	3.9	3.7	4.4	3.9	3.7	4.5	4	3.6	4.6	4	3.6	4.6	4	3.6	190
195				4.2	3.8	3.7	4.3	3.9	3.7	4.4	3.9	3.6	4.5	3.9	3.6	4.5	3.9	3.5	195
200				4.1	3.8	3.7	4.2	3.8	3.7	4.3	3.8	3.6	4.4	3.8	3.6	4.4	3.8	3.5	200
205				4	3.7	3.7	4.1	3.8	3.7	4.2	3.8	3.6	4.3	3.8	3.6	4.3	3.8	3.5	205
210				3.8	3.7		4	3.7	3.7	4.1	3.7	3.6	4.2	3.7	3.6	4.2	3.7	3.5	210
215				3.7	3.7		3.9	3.7	3.7	4	3.7	3.6	4.1	3.7	3.6	4.1	3.7	3.5	215
220				3.6	3.7		3.8	3.7	3.7	3.9	3.7	3.6	4	3.7	3.6	4	3.6	3.5	220
225				3.5	3.7		3.7	3.6		3.9	3.6	3.6	3.9	3.6	3.6	4	3.6	3.5	225
230				3.4	3.7		3.6	3.6		3.8	3.6	3.6	3.9	3.6	3.6	3.9	3.6	3.5	230
235				3.4			3.6	3.6		3.7	3.6		3.8	3.6	3.6	3.8	3.5	3.5	235
240							3.5	3.6		3.6	3.6		3.7	3.6	3.6	3.7	3.5	3.5	240
245							3.4			3.6	3.6		3.6	3.5	3.6	3.7	3.5	3.5	245
250										3.5	3.6		3.6	3.5		3.6	3.5	3.5	250
255										3.4	3.6		3.6	3.5		3.6	3.5	3.5	255
260										3.4			3.5	3.5		3.5	3.5		260
265													3.4	3.5		3.5	3.5		265
270													3.4			3.4	3.5		270
275													3.4			3.4			275
280																3.4			280
285																3.3			285

t\_259\_107\_16151 / 36151\_00\_000

# Lifting capacities Forces de levage

TVNZK

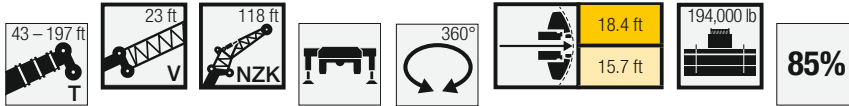

Jib Length	170 ft + 23 ft			180 ft + 23 ft			184 ft + 23 ft			194 ft + 23 ft			197 ft + 23 ft			Jib Length
	0°	22,5°	45°	0°	22,5°	45°	0°	22,5°	45°	0°	22,5°	45°	0°	22,5°	45°	
55	7.3															55
60	7.3			6.2			6.3									60
65	7.2			6.2			6.3			5.9			5.8			65
70	7.2			6.2			6.3			5.9			5.8			70
75	7.2			6.2			6.3			5.9			5.8			75
80	7.1			6.2			6.3			5.9			5.8			80
85	7.1			6.2			6.3			5.8			5.7			85
90	7			6.2			6.3			5.8			5.7			90
95	7			6.2			6.3			5.8			5.7			95
100	6.8			6.2			6.2			5.8			5.7			100
105	6.7	5.5		6.1			6.2			5.8			5.7			105
110	6.5	5.3		6	5		6	5.1		5.7			5.7			110
115	6.4	5.2		5.9	4.9		5.9	5		5.6	4.8		5.6	4.7		115
120	6.2	5.1		5.7	4.8		5.8	4.9		5.5	4.7		5.5	4.7		120
125	6.1	5		5.6	4.7		5.7	4.8		5.4	4.6		5.4	4.6		125
130	6	4.9		5.5	4.6		5.6	4.7		5.3	4.5		5.3	4.5		130
135	5.8	4.8	3.9	5.4	4.5		5.5	4.6		5.2	4.4		5.2	4.4		135
140	5.7	4.7	3.9	5.3	4.4	3.7	5.4	4.5	3.7	5.1	4.4		5.1	4.3		140
145	5.6	4.6	3.8	5.2	4.4	3.7	5.2	4.4	3.7	5	4.3	3.6	5	4.3	3.6	145
150	5.4	4.5	3.8	5.1	4.3	3.7	5.1	4.3	3.7	4.9	4.2	3.6	4.9	4.2	3.6	150
155	5.3	4.4	3.7	5	4.2	3.6	5	4.3	3.6	4.8	4.1	3.5	4.8	4.1	3.5	155
160	5.2	4.3	3.7	4.9	4.1	3.6	4.9	4.2	3.6	4.7	4.1	3.5	4.7	4	3.5	160
165	5.1	4.2	3.6	4.8	4.1	3.6	4.8	4.1	3.6	4.7	4	3.5	4.6	4	3.5	165
170	5	4.2	3.6	4.7	4	3.5	4.7	4	3.5	4.6	3.9	3.4	4.5	3.9	3.4	170
175	4.9	4.1	3.6	4.6	4	3.5	4.6	4	3.5	4.5	3.9	3.4	4.5	3.9	3.4	175
180	4.7	4	3.5	4.5	3.9	3.5	4.6	3.9	3.5	4.4	3.8	3.4	4.4	3.8	3.4	180
185	4.6	3.9	3.5	4.4	3.8	3.4	4.5	3.9	3.4	4.3	3.8	3.4	4.3	3.8	3.4	185
190	4.5	3.9	3.5	4.3	3.8	3.4	4.4	3.8	3.4	4.2	3.7	3.4	4.2	3.7	3.4	190
195	4.4	3.8	3.5	4.2	3.7	3.4	4.3	3.8	3.4	4.2	3.7	3.4	4.1	3.7	3.3	195
200	4.3	3.8	3.5	4.2	3.7	3.4	4.2	3.7	3.4	4.1	3.6	3.4	4.1	3.6	3.3	200
205	4.3	3.7	3.5	4.1	3.6	3.4	4.1	3.7	3.4	4	3.6	3.4	4	3.6	3.3	205
210	4.2	3.7	3.5	4	3.6	3.4	4.1	3.6	3.4	4	3.5	3.4	4	3.5	3.3	210
215	4.1	3.7	3.5	3.9	3.5	3.4	4	3.6	3.4	3.9	3.5	3.4	3.9	3.5	3.3	215
220	4	3.6	3.5	3.9	3.5	3.4	3.9	3.5	3.4	3.8	3.5	3.4	3.8	3.5	3.3	220
225	3.9	3.5	3.5	3.8	3.5	3.4	3.9	3.5	3.4	3.8	3.4	3.4	3.8	3.4	3.3	225
230	3.9	3.5	3.5	3.7	3.4	3.4	3.8	3.5	3.4	3.7	3.4	3.4	3.7	3.4	3.3	230
235	3.8	3.5	3.5	3.7	3.4	3.4	3.7	3.4	3.4	3.7	3.4	3.4	3.6	3.4	3.3	235
240	3.7	3.5	3.5	3.6	3.4	3.4	3.7	3.4	3.4	3.6	3.3	3.3	3.6	3.3	3.3	240
245	3.7	3.4	3.5	3.6	3.4	3.4	3.6	3.4	3.4	3.5	3.3	3.3	3.5	3.3	3.3	245
250	3.6	3.4	3.5	3.5	3.4	3.4	3.5	3.4	3.4	3.5	3.3	3.3	3.5	3.3	3.2	250
255	3.6	3.4	3.5	3.5	3.4	3.4	3.5	3.3	3.4	3.5	3.3	3.2	3.5	3.3	3.2	255
260	3.5	3.4	3.5	3.4	3.4	3.4	3.5	3.3	3.4	3.4	3.3	3.2	3.4	3.3	3.1	260
265	3.5	3.4	3.5	3.4		3.4	3.4	3.3	3.4	3.4	3.3	3.2	3.4	3.3	3.1	265
270	3.4	3.4	3.5	3.4		3.4	3.4	3.3	3.4	3.3	3.3	3.1	3.3	3.3	3.1	270
275	3.4	3.4		3.3			3.3	3.3	3.4	3.3		3.1	3.3	3.3	3	275
280	3.3	3.4		3.3			3.3	3.3	3.4	3.3		3.1	3.3		3	280
285	3.3	3.4		3.3			3.3	3.3		3.2			3.2		3	285
290	3.3			3.2			3.3			3.2			3.1			290
295	3.1			3.2			3.2			3			2.8			295
300				3.1			2.8			2.7			2.5			300
305										2.4						305

t\_259\_107\_16151 / 36151\_00\_000

# Lifting heights Hauteurs de levage

TVNZK

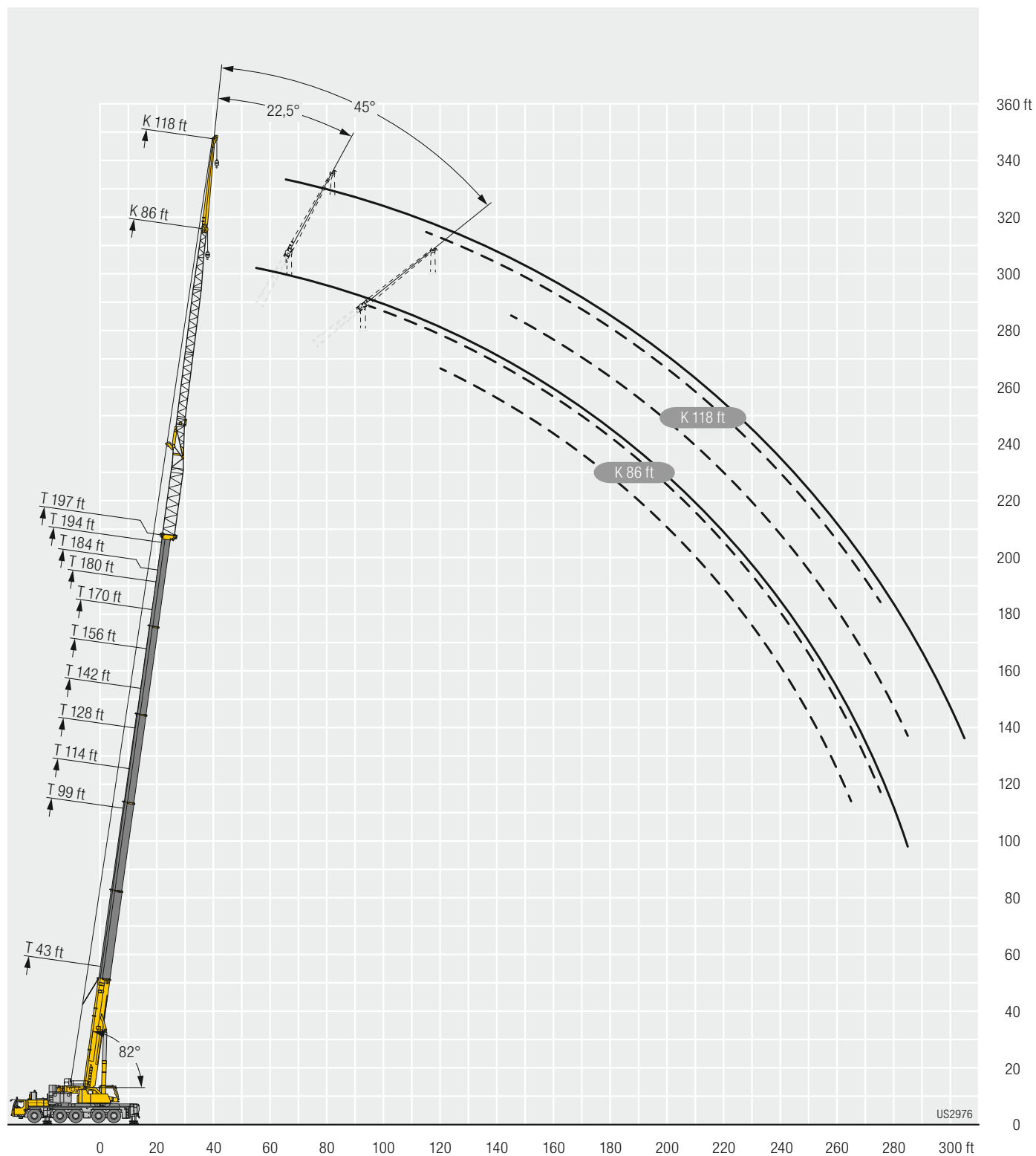

# Lifting capacities Forces de levage

TVNZK

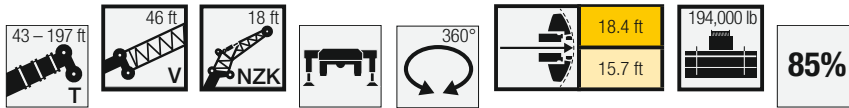

Jib ↙ ↘	43 ft + 46 ft			99 ft + 46 ft			114 ft + 46 ft			128 ft + 46 ft			142 ft + 46 ft			156 ft + 46 ft			Jib ↙ ↘
	18 ft																		
	0°	22,5°	45°	0°	22,5°	45°	0°	22,5°	45°	0°	22,5°	45°	0°	22,5°	45°	0°	22,5°	45°	
15	50.8																		15
16	50.7																		16
17	49.9																		17
18	48.9																		18
19	48																		19
20	47	44.2																	20
22	45.2	43.4																	22
24	43.2	41.7	40.2																24
26	41.3	40.1	39.2	50.4															26
28	39.5	38.5	37.7	49.2															28
30	37.8	37	36.3	48			47												30
32	36.3	35.7	35	46.8	43.5		46			43									32
34	34.8	34.3	33.7	45.6	42.5		45	42		42.3									34
36	33.5	33.1	32.6	44.3	41.4	39.4	44	41.1		41.5				38.3					36
38	32.1	32	31.5	43.1	40.3	38.5	42.9	40.1	38.2	40.7	38.3			37.8					38
40	30.9	30.9	30.5	41.8	39.3	37.5	41.9	39.1	37.4	39.8	37.6			37.2			33.5		40
45	28.2	28.5	28.1	38.9	36.9	35.4	39.2	37	35.4	37.8	35.8	34.4	35.7	34	32.7	32.5	31.2		45
50	26	26.3	26.1	36.3	34.7	33.4	36.8	35	33.6	35.8	34.1	32.9	34.1	32.6	31.6	31.4	30.2	29.3	50
55	23.9	24.3	24.4	34	32.7	31.6	34.6	33.1	31.9	33.9	32.5	31.4	32.5	31.2	30.4	30.3	29.2	28.5	55
60	22.1	22.5	22.8	31.8	31	30	32.7	31.4	30.4	32.2	31	30.1	31.1	30	29.2	29.1	28.2	27.6	60
65	20.6	20.9	21.2	30	29.4	28.6	30.9	30	29.1	30.6	29.6	28.8	29.7	28.8	28.1	28	27.2	26.7	65
70	19.2	19.5	19.8	28.2	27.9	27.2	29.2	28.5	27.8	29.1	28.4	27.7	28.5	27.7	27.1	27	26.3	25.8	70
75	18	18.3	18.6	26.8	26.5	25.9	27.7	27.2	26.6	27.7	27.2	26.6	27.3	26.7	26.1	26	25.4	25	75
80	16.8	17.2	17.5	25.3	25.2	24.9	26.3	26	25.5	26.5	26.1	25.6	26.1	25.7	25.2	25	24.6	24.2	80
85	15.7	16.3	16.6	24	23.9	23.8	25.1	24.9	24.5	25.3	25	24.7	25.1	24.7	24.3	24.2	23.8	23.5	85
90	14.8	15.4	13	22.9	22.8	22.8	23.9	23.7	23.6	24.3	24.1	23.8	24.1	23.9	23.5	23.3	23.1	22.8	90
95	13.9	14.7	9.1	21.7	21.7	21.8	22.8	22.6	22.7	23.3	23.1	23	23.1	23	22.8	22.5	22.4	22.2	95
100	13.3	13.8		20.8	20.7	20.9	21.8	21.7	21.8	22.3	22.2	22.2	22.3	22.2	22.1	21.7	21.7	21.5	100
105				19.8	19.9	20	20.9	20.8	21	21.4	21.4	21.4	21.5	21.4	21.4	21	21	20.9	105
110				19	19	19.2	20	20	20.2	20.6	20.6	20.7	20.7	20.7	20.8	20.4	20.4	20.4	110
115				18.2	18.3	18.5	19.2	19.3	19.5	19.8	19.8	20	20	20	20.2	19.7	19.8	19.8	115
120				17.4	17.6	17.8	18.5	18.5	18.7	19.1	19.1	19.3	19.4	19.3	19.5	19.1	19.1	19.3	120
125				16.7	17	17.2	17.8	17.9	18.1	18.4	18.5	18.7	18.7	18.7	19	18.5	18.6	18.8	125
130				16	16.4	16.7	17.2	17.3	17.6	17.8	17.9	18.1	18.1	18.2	18.4	18	18.1	18.3	130
135				15.4	15.8	16	16.5	16.7	17	17.2	17.3	17.6	17.6	17.7	17.9	17.5	17.6	17.8	135
140				14.8	15.3	12.7	15.9	16.2	16.5	16.7	16.8	17.1	17	17.1	17.4	17	17.1	17.4	140
145				14.2	14.9		15.4	15.7	16.1	16.1	16.3	16.6	16.6	16.7	16.9	16.6	16.7	17	145
150				13.7			14.8	15.3	14.2	15.6	15.9	16.2	16.1	16.2	16.5	16.2	16.3	16.6	150
155				13.4			14.3	14.9		15.1	15.5	15.7	15.6	15.8	16.1	15.7	15.9	16.2	155
160							13.9			14.6	15.1	15.2	15.2	15.4	15.7	15.4	15.5	15.8	160
165							13.5			14.2	14.7	12.7	14.8	15.1	15.2	15	15.2	15.4	165
170							12.2			13.8	14.4		14.4	14.8	14.8	14.6	14.9	15	170
175										13.4			14	14.5	13.5	14.3	14.5	14.5	175
180										12.7			13.6	14.1		13.6	13.7	13.7	180
185										9.7			13.2			13.1	13.1	13.3	185
190													12.7			12.7	12.8	12.6	190
195													9.9			12.3	12.4		195
200													5.8			11.6			200
205																10.3			205
210																8.5			210

t\_259\_107\_20151 / 40151\_00\_000

# Lifting capacities Forces de levage

TVNZK

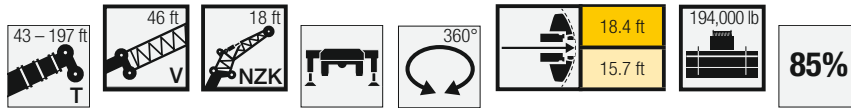

Jib Length (ft)	170 ft + 46 ft			180 ft + 46 ft			184 ft + 46 ft			194 ft + 46 ft			197 ft + 46 ft			Jib Length (ft)
	0°	22,5°	45°	0°	22,5°	45°	18 ft			0°	22,5°	45°	0°	22,5°	45°	
45	28.6															45
50	27.9	27		23.6			24			19.8			19.4			50
55	27.1	26.4	25.9	23.2	22.7		23.6	23.1		19.5			19.2			55
60	26.4	25.7	25.3	22.7	22.3	22.1	23.1	22.6	22.4	19.2	19.1		18.9	18.7		60
65	25.6	25	24.6	22.2	21.8	21.7	22.6	22.2	22	18.9	18.8	18.7	18.6	18.5	18.5	65
70	24.8	24.3	24	21.6	21.3	21.2	22	21.7	21.5	18.5	18.5	18.5	18.3	18.2	18.2	70
75	24	23.6	23.3	21.1	20.8	20.7	21.5	21.2	21.1	18.2	18.1	18.2	17.9	17.9	17.9	75
80	23.3	23	22.7	20.6	20.3	20	21	20.7	20.6	17.8	17.8	17.8	17.6	17.6	17.6	80
85	22.6	22.3	22.1	20	19.7	19.4	20.4	20.3	20.1	17.5	17.5	17.5	17.3	17.2	17.3	85
90	21.9	21.7	21.5	19.4	19.1	18.8	19.9	19.7	19.5	17.1	17.1	17.1	16.9	16.9	16.9	90
95	21.2	21.1	21	18.9	18.4	18.2	19.4	19.2	18.9	16.8	16.7	16.7	16.6	16.5	16.5	95
100	20.6	20.6	20.5	18.3	17.9	17.6	19	18.6	18.3	16.4	16.3	16.3	16.3	16.1	16.2	100
105	20	20	20	17.8	17.3	17.1	18.5	18	17.8	16.1	15.9	15.9	15.9	15.8	15.8	105
110	19.4	19.5	19.5	17.2	16.8	16.6	18	17.5	17.3	15.7	15.6	15.6	15.6	15.4	15.4	110
115	18.9	19	19	16.6	16.3	16.1	17.5	17	16.8	15.4	15.2	15.2	15.2	15.1	15.1	115
120	18.4	18.5	18.6	16	15.8	15.7	17	16.5	16.3	15	14.8	14.8	14.9	14.7	14.7	120
125	17.9	18	18.1	15.5	15.3	15.3	16.5	16	15.9	14.6	14.4	14.4	14.5	14.3	14.4	125
130	17.5	17.5	17.7	15	14.8	14.8	16	15.6	15.5	14.3	14	14.1	14.2	14	14	130
135	17	17.1	17.3	14.5	14.4	14.4	15.5	15.2	15.1	13.9	13.7	13.7	13.8	13.6	13.6	135
140	16.6	16.7	17	14.1	13.9	13.9	15.1	14.8	14.7	13.5	13.3	13.3	13.4	13.3	13.3	140
145	16.2	16.3	16.6	13.6	13.5	13.5	14.6	14.4	14.3	13.1	12.9	13	13.1	12.9	12.9	145
150	15.8	15.9	16.2	13.2	13.1	13.1	14.2	14	14	12.7	12.6	12.6	12.7	12.6	12.6	150
155	15.5	15.6	15.9	12.8	12.7	12.7	13.8	13.6	13.6	12.4	12.3	12.3	12.3	12.2	12.2	155
160	15.1	15.3	15.5	12.3	12.3	12.3	13.4	13.3	13.3	12	11.9	12	12	11.9	11.9	160
165	14.8	15	15.1	11.9	11.9	12	13	12.9	13	11.7	11.6	11.7	11.7	11.6	11.7	165
170	14.5	14.6	14.8	11.4	11.5	11.5	12.7	12.6	12.7	11.4	11.3	11.4	11.4	11.3	11.4	170
175	14.2	14.3	14.4	11	11.1	11.1	12.3	12.3	12.4	11	11	11.1	11	11	11.1	175
180	13.6	13.8	13.9	10.6	10.7	10.7	12	12	12	10.7	10.7	10.7	10.7	10.7	10.8	180
185	12.8	13	13	10.2	10.3	10.3	11.7	11.7	11.8	10.3	10.3	10.4	10.3	10.3	10.4	185
190	12	12.1	12.1	9.8	9.9	9.9	11.4	11.4	11.5	10	10	10.1	10	10	10.1	190
195	11.2	11.3	11.3	9.5	9.5	9.6	11.1	11.1	11.2	9.7	9.7	9.8	9.7	9.7	9.8	195
200	10.5	10.5	10.6	9.1	9.1	9.2	10.7	10.8	10.9	9.3	9.4	9.4	9.4	9.4	9.5	200
205	10.2	10.2		8.8	8.8	8.9	10	10.2	10.2	9	9.1	9.1	9.1	9.1	9.1	205
210	9.9	10		8.5	8.5	8.6	9.4	9.5	9.5	8.7	8.8	8.8	8.8	8.8	8.8	210
215	9.7			8.2	8.2		8.7	8.8	8.8	8.4	8.5	8.5	8.5	8.5	8.6	215
220	8.2			7.9			8.1	8.2		8.2	8.2	8.3	8.1	8.2	8.2	220
225	5.6			7.7			7.6			7.7	7.7		7.5	7.6	7.6	225
230				6.9			7			7.2	7.3		7.1	7.1		230
235				4.5			5.4			6.8	6.8		6.6	6.7		235
240							2.7			6.1			6.2			240
245										4.5			5			245
250													2.9			250

t\_259\_107\_20151 / 40151\_00\_000

# Lifting capacities Forces de levage

TVNZK

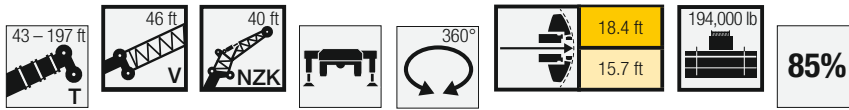

Jib ↙ ↘	43 ft + 46 ft			99 ft + 46 ft			114 ft + 46 ft			128 ft + 46 ft			142 ft + 46 ft			156 ft + 46 ft			Jib ↙ ↘
	40 ft																		
	0°	22,5°	45°	0°	22,5°	45°	0°	22,5°	45°	0°	22,5°	45°	0°	22,5°	45°	0°	22,5°	45°	
15	38.1																		15
16	38.1																		16
17	38																		17
18	37.5																		18
19	37.1																		19
20	36.6																		20
22	35.6																		22
24	34.5																		24
26	33.4																		26
28	32.2			37.5															28
30	31.1	28.7		36.8			35.5												30
32	30.1	28.3		36.2			35												32
34	29	27.5		35.5			34.4			32.4									34
36	28.1	26.6		34.7			33.8			31.9			29.2						36
38	27.1	25.7		33.9			33.1			31.4			28.9						38
40	26.3	24.9		33.1			32.5			30.9			28.6						40
45	24.2	23	22	31.2	27.5		30.8	27.1		29.6			27.6			24.9			45
50	22.4	21.4	20.6	29.3	26		29.2	25.9		28.2	25.1		26.5			24.2			50
55	20.7	19.9	19.3	27.7	24.6	22.3	27.7	24.6	22	27	24.1		25.5	23		23.4			55
60	19.3	18.6	18.1	26.1	23.3	21.3	26.3	23.4	21.2	25.7	23	20.8	24.5	22.1		22.7	20.8		60
65	17.9	17.4	17.1	24.7	22.1	20.4	25	22.3	20.3	24.5	22	20	23.5	21.3	19.4	21.9	20.1		65
70	16.8	16.3	16.1	23.4	21.1	19.5	23.7	21.3	19.5	23.4	21.1	19.3	22.6	20.5	18.8	21.2	19.4	17.9	70
75	15.7	15.4	15.2	22.1	20.1	18.7	22.6	20.3	18.8	22.4	20.2	18.6	21.7	19.7	18.2	20.4	18.8	17.4	75
80	14.7	14.5	14.4	21	19.1	18	21.5	19.5	18.1	21.4	19.4	18	20.9	19	17.6	19.8	18.1	16.9	80
85	13.9	13.7	13.6	20	18.3	17.3	20.5	18.6	17.5	20.5	18.6	17.4	20	18.3	17	19.1	17.5	16.4	85
90	13	13	13	19	17.5	16.6	19.6	17.8	16.8	19.6	17.9	16.8	19.2	17.6	16.5	18.5	17	15.9	90
95	12.3	12.3	12.4	18	16.8	16	18.7	17.1	16.3	18.8	17.2	16.3	18.5	17	16	17.8	16.4	15.5	95
100	11.7	11.6	11.8	17.2	16.1	15.4	17.8	16.4	15.7	18.1	16.6	15.8	17.8	16.4	15.6	17.2	15.9	15.1	100
105	11	11	11.3	16.4	15.4	14.8	17.1	15.8	15.2	17.4	16	15.3	17.2	15.9	15.1	16.6	15.4	14.7	105
110	10.4	10.5	10.8	15.7	14.8	14.3	16.4	15.2	14.7	16.7	15.4	14.8	16.6	15.4	14.7	16.1	15	14.3	110
115	9.9	10	6.9	15	14.2	13.8	15.7	14.7	14.2	16	14.9	14.4	16	14.9	14.3	15.6	14.5	14	115
120	9.5	9.6		14.4	13.7	13.4	15.1	14.2	13.8	15.4	14.4	13.9	15.4	14.4	13.9	15.1	14.1	13.6	120
125				13.8	13.2	13	14.5	13.7	13.4	14.8	13.9	13.6	14.9	14	13.5	14.6	13.7	13.3	125
130				13.2	12.7	12.6	13.9	13.2	13	14.3	13.5	13.2	14.4	13.6	13.2	14.1	13.4	13	130
135				12.7	12.3	12.2	13.4	12.8	12.6	13.8	13.1	12.8	13.9	13.1	12.9	13.7	13	12.7	135
140				12.2	11.8	11.9	12.9	12.4	12.3	13.3	12.7	12.5	13.5	12.8	12.5	13.3	12.6	12.4	140
145				11.8	11.4	11.5	12.4	12	12	12.9	12.3	12.2	13	12.4	12.2	12.9	12.3	12.1	145
150				11.3	11	11.2	12	11.6	11.6	12.4	11.9	11.9	12.6	12.1	12	12.5	12	11.8	150
155				10.9	10.7		11.6	11.2	11.3	12	11.6	11.6	12.3	11.8	11.7	12.2	11.7	11.6	155
160				10.5	10.4		11.2	10.9	11	11.6	11.2	11.3	11.9	11.4	11.4	11.9	11.4	11.4	160
165				10.1	10		10.7	10.5	10.8	11.2	10.9	11	11.5	11.1	11.1	11.5	11.1	11.1	165
170				9.8	9.8		10.4	10.2		10.9	10.6	10.8	11.2	10.8	10.9	11.2	10.8	10.9	170
175				9.5	9.6		10.1	10		10.5	10.3	10.5	10.9	10.5	10.7	10.9	10.5	10.6	175
180				8.4			9.8	9.7		10.2	10		10.5	10.2	10.5	10.6	10.3	10.4	180
185							9.5	9.6		9.9	9.8		10.2	10	10.3	10.3	10.1	10.3	185
190							9.3			9.7	9.6		10	9.8		10.1	9.8	10.1	190
195										9.4	9.4		9.7	9.6		9.8	9.6	10	195
200										9.2	9.3		9.5	9.4		9.6	9.5	9.8	200
205										7.2			9.3	9.2		9.4	9.3		205
210													9	9.2		9.1	9.2		210
215													8.2	9		8.9	8.9		215
220													7			8.8	8.9		220
225																8.2	8.8		225
230																7.1			230
235																4.3			235

t\_259\_107\_21151 / 41151\_00\_000



# Lifting capacities Forces de levage

TVNZK

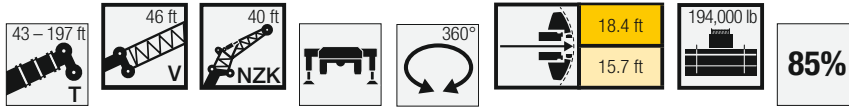

45 50 55 60 65 70 75 80 85 90 95 100 105 110 115 120 125 130 135 140 145 150 155 160 165 170 175 180 185 190 195 200 205 210 215 220 225 230 235 240 245 250 255 260 265	170 ft + 46 ft			180 ft + 46 ft			184 ft + 46 ft			194 ft + 46 ft			197 ft + 46 ft			45 50 55 60 65 70 75 80 85 90 95 100 105 110 115 120 125 130 135 140 145 150 155 160 165 170 175 180 185 190 195 200 205 210 215 220 225 230 235 240 245 250 255 260 265
	0°	22,5°	45°	0°	22,5°	45°	0°	22,5°	45°	0°	22,5°	45°	0°	22,5°	45°	
	20.5			16.7			17									
	20.1															
	19.7			16.4			16.7			15.1			14.8			
	19.2	18		16.1			16.5			14.9			14.6			
	18.7	17.7		15.8	15.2		16.1	15.5		14.7			14.4			
	18.2	17.2		15.5	14.9		15.8	15.2		14.4	13.9		14.2	13.7		
	17.7	16.8	15.8	15.2	14.6		15.5	14.9		14.2	13.7		13.9	13.5		
	17.3	16.3	15.4	14.9	14.3	13.7	15.2	14.6	13.9	13.9	13.5		13.7	13.3		
	16.8	15.9	15.1	14.5	14	13.5	14.8	14.2	13.7	13.6	13.2	12.8	13.5	13	12.6	
	16.3	15.4	14.7	14.2	13.7	13.2	14.5	13.9	13.4	13.4	13	12.6	13.2	12.8	12.4	
	15.9	15	14.3	13.9	13.4	12.9	14.1	13.6	13.1	13.1	12.7	12.3	12.9	12.6	12.2	
	15.4	14.6	14	13.6	13.1	12.6	13.8	13.3	12.9	12.9	12.4	12.1	12.7	12.3	12	
	15	14.3	13.7	13.3	12.7	12.2	13.5	13	12.6	12.6	12.2	11.9	12.5	12.1	11.8	
	14.6	13.9	13.4	13	12.3	11.8	13.2	12.7	12.3	12.3	12	11.6	12.2	11.9	11.6	
	14.2	13.5	13.1	12.6	11.9	11.5	12.9	12.4	11.9	12.1	11.7	11.3	12	11.6	11.3	
	13.8	13.2	12.8	12.3	11.6	11.2	12.6	12	11.6	11.8	11.4	11	11.7	11.3	11	
	13.4	12.9	12.6	12	11.2	10.9	12.3	11.7	11.3	11.6	11.1	10.7	11.5	11	10.7	
	13.1	12.5	12.3	11.6	10.9	10.6	12	11.3	11	11.3	10.8	10.5	11.2	10.7	10.4	
	12.7	12.2	12	11.3	10.6	10.3	11.7	11	10.7	11.1	10.5	10.2	11	10.4	10.2	
	12.4	12	11.8	10.9	10.3	10	11.4	10.7	10.4	10.8	10.2	10	10.8	10.2	9.9	
	12.1	11.7	11.6	10.6	10	9.8	11.1	10.4	10.2	10.6	9.9	9.7	10.5	9.9	9.7	
	11.8	11.5	11.4	10.3	9.7	9.5	10.8	10.1	9.9	10.3	9.7	9.5	10.2	9.6	9.5	
	11.5	11.2	11.1	10	9.5	9.3	10.5	9.9	9.7	10	9.4	9.3	10	9.4	9.2	
	11.2	11	10.9	9.7	9.2	9.1	10.2	9.6	9.5	9.7	9.2	9.1	9.7	9.2	9	
	10.9	10.8	10.8	9.4	9	8.9	9.9	9.4	9.2	9.5	9	8.9	9.4	9	8.8	
	10.7	10.5	10.6	9.2	8.7	8.7	9.6	9.1	9	9.2	8.8	8.7	9.2	8.7	8.7	
	10.5	10.3	10.4	8.9	8.5	8.5	9.4	8.9	8.8	9	8.6	8.5	9	8.5	8.5	
	10.2	10.1	10.3	8.7	8.3	8.3	9.1	8.7	8.7	8.7	8.4	8.3	8.7	8.4	8.3	
	10	9.9	10.1	8.4	8.1	8.2	8.9	8.5	8.5	8.5	8.2	8.2	8.5	8.2	8.2	
	9.8	9.8	10	8.2	7.9	8	8.7	8.3	8.3	8.3	8	8	8.3	8	8	
	9.6	9.6	9.8	8	7.8	7.8	8.4	8.1	8.2	8.1	7.8	7.8	8.1	7.8	7.9	
	9.4	9.4	9.7	7.8	7.6	7.7	8.2	8	8	7.9	7.7	7.7	7.9	7.7	7.7	
	9.2	9.2	9.5	7.6	7.5	7.6	8.1	7.8	7.9	7.6	7.5	7.6	7.7	7.5	7.6	
	9.1	9.1	9.4	7.3	7.3	7.4	7.9	7.7	7.8	7.5	7.4	7.5	7.5	7.4	7.5	
	8.7	8.9	9.2	7.1	7.1	7.3	7.7	7.5	7.7	7.3	7.3	7.4	7.3	7.3	7.4	
	8.2	8.6		6.9	6.9	7.1	7.6	7.4	7.6	7.1	7.1	7.2	7.1	7.1	7.2	
	7.6	8		6.7	6.7	6.8	7.4	7.3	7.5	6.9	7	7	6.9	6.9	7	
	7.2	7.4		6.4	6.5		7.3	7.2	7.5	6.7	6.8	6.8	6.7	6.8	6.9	
	7.1	7.1		6.2	6.3		6.9	7.2		6.5	6.6	6.6	6.5	6.6	6.7	
	6.7	7.1		6.1	6.1		6.5	6.7		6.3	6.4		6.2	6.4	6.5	
	4.9			5.9	5.9		6.1	6.3		6	6.2		5.8	6.1		
				5.5			5.6	5.9		5.6	5.8		5.4	5.7		
				3.9			4.3			5.2	5.4		5.1	5.3		
										4.7	5		4.7	4.9		
										3.2			3.6			

t\_259\_107\_21151 / 41151\_00\_000

# Lifting capacities Forces de levage

TVNZK

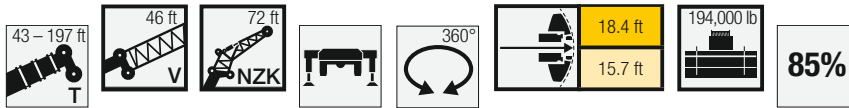

Lifting hook icon	43 ft + 46 ft			99 ft + 46 ft			114 ft + 46 ft			128 ft + 46 ft			142 ft + 46 ft			156 ft + 46 ft			Lifting hook icon
	72 ft																		
	0°	22,5°	45°	0°	22,5°	45°	0°	22,5°	45°	0°	22,5°	45°	0°	22,5°	45°	0°	22,5°	45°	
20	16.3																		20
22	16.8																		22
24	16.8																		24
26	16.7																		26
28	16.7																		28
30	16.6			16.9															30
32	16.5			16.8															32
34	16.5			16.8			16.3												34
36	16.4			16.8			16.2			15.5									36
38	16.3			16.7			16.2			15.5									38
40	16.2			16.7			16.1			15.4			14.5						40
45	15.8			16.5			16			15.3			14.4			13.3			45
50	15.2	14.3		16.4			15.9			15.2			14.3			13.2			50
55	14.6	13.9		16.2			15.7			15.1			14.2			13.1			55
60	13.9	13.4		16	14.4		15.6			15			14.1			13.1			60
65	13.2	13		15.6	14		15.4	13.9		14.8			14.1			13			65
70	12.5	12.5	10.8	15.2	13.7		15	13.6		14.6	13.4		13.9			12.9			70
75	11.9	11.9	10.5	14.7	13.4		14.6	13.3		14.2	13.1		13.6	12.8		12.8			75
80	11.2	11.2	10.4	14.2	13.1	10.8	14.1	13		13.8	12.9		13.3	12.5		12.5	11.8		80
85	10.7	10.7	10.2	13.7	12.8	10.6	13.7	12.7	10.6	13.4	12.5		12.9	12.2		12.2	11.5		85
90	10.1	10.1	10	13.2	12.3	10.5	13.2	12.3	10.5	13	12.2	10.4	12.6	11.8	10.2	11.9	11.2		90
95	9.6	9.6	9.6	12.7	11.9	10.4	12.8	11.9	10.3	12.6	11.8	10.3	12.2	11.4	10.1	11.6	10.9	9.9	95
100	9.1	9.1	9.1	12.2	11.4	10.3	12.3	11.5	10.2	12.2	11.4	10.2	11.9	11.1	10	11.3	10.6	9.8	100
105	8.6	8.7	8.7	11.7	11	10.1	11.9	11.1	10.1	11.8	11	10	11.5	10.8	9.9	11	10.3	9.6	105
110	8.2	8.3	8.4	11.2	10.6	10	11.4	10.7	10	11.4	10.7	9.9	11.2	10.5	9.7	10.7	10	9.3	110
115	7.8	7.9	8	10.8	10.2	9.7	11	10.3	9.7	11	10.3	9.6	10.8	10.2	9.4	10.4	9.8	9.1	115
120	7.4	7.5	7.7	10.4	9.8	9.4	10.6	10	9.5	10.7	10	9.4	10.5	9.8	9.2	10.1	9.5	8.9	120
125	7.1	7.2	7.4	10	9.5	9.1	10.2	9.6	9.2	10.3	9.7	9.1	10.2	9.6	9	9.8	9.2	8.7	125
130	6.8	6.9	7.1	9.6	9.1	8.8	9.9	9.3	8.9	10	9.4	8.9	9.9	9.3	8.8	9.6	9	8.5	130
135	6.5	6.6	6.9	9.2	8.8	8.6	9.5	9	8.7	9.6	9.1	8.7	9.6	9	8.5	9.3	8.8	8.3	135
140	6.2	6.4	6.7	8.9	8.5	8.3	9.2	8.7	8.4	9.3	8.8	8.4	9.3	8.7	8.3	9	8.5	8.1	140
145	6	6.2	6.6	8.5	8.2	8.1	8.9	8.4	8.2	9	8.5	8.2	9	8.5	8.1	8.8	8.3	7.9	145
150	5.8	6		8.2	7.9	7.9	8.5	8.2	8	8.7	8.3	8	8.7	8.3	8	8.5	8.1	7.8	150
155	5.6			7.9	7.7	7.7	8.2	7.9	7.8	8.4	8	7.8	8.5	8	7.8	8.3	7.9	7.6	155
160				7.6	7.4	7.5	8	7.7	7.6	8.2	7.8	7.7	8.2	7.8	7.6	8.1	7.7	7.5	160
165				7.4	7.2	7.3	7.7	7.4	7.5	7.9	7.6	7.5	8	7.6	7.5	7.8	7.5	7.4	165
170				7.1	7	7.1	7.4	7.2	7.3	7.7	7.4	7.4	7.7	7.4	7.3	7.6	7.3	7.2	170
175				6.9	6.8	7	7.2	7	7.1	7.4	7.2	7.2	7.5	7.2	7.2	7.4	7.1	7.1	175
180				6.7	6.6	6.8	7	6.9	7	7.2	7	7.1	7.3	7.1	7.1	7.2	7	7	180
185				6.5	6.4	6.7	6.8	6.7	6.9	7	6.8	6.9	7.1	6.9	7	7.1	6.9	6.9	185
190				6.3	6.3		6.6	6.5	6.7	6.8	6.7	6.8	6.9	6.8	6.8	6.9	6.7	6.8	190
195				6.1	6.1		6.4	6.4	6.6	6.6	6.5	6.7	6.7	6.6	6.7	6.7	6.6	6.7	195
200				5.9	6		6.2	6.2		6.4	6.4	6.6	6.6	6.5	6.6	6.6	6.4	6.6	200
205				5.8	5.9		6.1	6.1		6.3	6.2		6.4	6.3	6.5	6.4	6.3	6.5	205
210				5.7			5.9	6		6.1	6.1		6.3	6.2	6.4	6.3	6.2	6.4	210
215							5.8	5.9		6	6		6.1	6.1	6.4	6.1	6.1	6.3	215
220							5.6			5.8	5.9		6	6		6	5.9	6.2	220
225							5.4			5.7	5.8		5.8	5.9		5.9	5.9	6.2	225
230										5.6	5.7		5.7	5.8		5.8	5.8	6.1	230
235										5.5			5.6	5.7		5.7	5.7	6.1	235
240										4.3			5.5	5.6		5.5	5.6		240
245													5.4			5.4	5.5		245
250													4.7			5.4	5.5		250
255																5.3	5.5		255
260																4.8			260
265																3.7			265

t\_259\_107\_23151 / 43151\_00\_000

# Lifting capacities Forces de levage

TVNZK

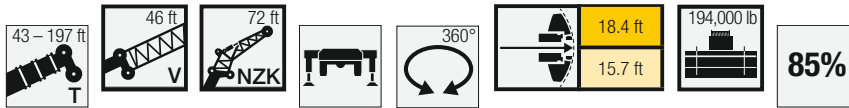

Jib ↙ ↘	170 ft + 46 ft			180 ft + 46 ft			184 ft + 46 ft			194 ft + 46 ft			197 ft + 46 ft			Jib ↙ ↘
	72 ft															
	0°	22,5°	45°	0°	22,5°	45°	0°	22,5°	45°	0°	22,5°	45°	0°	22,5°	45°	
50	11.9															50
55	11.8			10.1			10.3									55
60	11.8			10.1			10.2			9.3			9.2			60
65	11.7			10.1			10.2			9.3			9.1			65
70	11.7			10			10.2			9.3			9.1			70
75	11.6			10			10.1			9.3			9.1			75
80	11.4			9.8			10			9.2			9			80
85	11.1	10.6		9.7	9.1		9.8			9			8.9			85
90	10.9	10.4		9.5	9.1		9.6	9.3		8.9	8.4		8.7	8.1		90
95	10.6	10.1		9.3	9		9.5	9.1		8.7	8.4		8.6	8.1		95
100	10.4	9.9		9.1	8.8		9.3	8.9		8.6	8.3		8.5	8.1		100
105	10.2	9.7	9	9	8.6		9.1	8.7		8.4	8.2		8.3	8		105
110	9.9	9.4	8.8	8.8	8.4	8	8.9	8.6	8.1	8.3	8	7.5	8.2	7.9		110
115	9.7	9.2	8.6	8.6	8.2	7.9	8.7	8.4	8	8.1	7.9	7.5	8	7.8	7.3	115
120	9.4	9	8.4	8.4	8.1	7.7	8.5	8.2	7.8	8	7.7	7.4	7.9	7.6	7.3	120
125	9.2	8.7	8.3	8.2	7.9	7.6	8.4	8	7.7	7.8	7.6	7.3	7.8	7.5	7.3	125
130	9	8.5	8.1	8	7.7	7.5	8.2	7.8	7.5	7.7	7.4	7.2	7.6	7.4	7.2	130
135	8.8	8.3	7.9	7.9	7.5	7.3	8	7.7	7.4	7.5	7.3	7.1	7.5	7.3	7.1	135
140	8.5	8.1	7.8	7.7	7.4	7.1	7.8	7.5	7.3	7.4	7.2	7	7.4	7.1	7	140
145	8.3	7.9	7.6	7.5	7.2	7	7.7	7.4	7.2	7.3	7.1	6.9	7.2	7	6.9	145
150	8.1	7.7	7.5	7.4	7	6.8	7.5	7.2	7	7.1	6.9	6.7	7.1	6.9	6.7	150
155	7.9	7.6	7.4	7.2	6.8	6.7	7.4	7.1	6.9	7	6.8	6.6	7	6.7	6.6	155
160	7.7	7.4	7.3	7.1	6.7	6.5	7.2	6.9	6.7	6.9	6.6	6.5	6.8	6.6	6.4	160
165	7.5	7.2	7.1	6.9	6.5	6.4	7.1	6.7	6.6	6.8	6.5	6.3	6.7	6.4	6.3	165
170	7.4	7.1	7	6.7	6.3	6.2	6.9	6.6	6.4	6.6	6.3	6.2	6.6	6.3	6.2	170
175	7.2	6.9	6.9	6.6	6.2	6.1	6.8	6.4	6.3	6.5	6.2	6.1	6.5	6.2	6.1	175
180	7	6.8	6.8	6.4	6.1	6	6.7	6.3	6.2	6.4	6	6	6.4	6	6	180
185	6.9	6.7	6.7	6.3	5.9	5.9	6.5	6.1	6.1	6.3	5.9	5.9	6.2	5.9	5.8	185
190	6.7	6.5	6.6	6.1	5.8	5.8	6.3	6	6	6.1	5.8	5.7	6.1	5.8	5.7	190
195	6.6	6.4	6.5	5.9	5.7	5.6	6.2	5.9	5.8	6	5.7	5.6	6	5.7	5.6	195
200	6.4	6.3	6.4	5.8	5.5	5.5	6.1	5.7	5.7	5.8	5.5	5.6	5.8	5.6	5.5	200
205	6.3	6.2	6.3	5.7	5.4	5.4	5.9	5.6	5.6	5.7	5.4	5.5	5.7	5.4	5.5	205
210	6.2	6.1	6.3	5.5	5.3	5.4	5.8	5.5	5.6	5.6	5.3	5.4	5.6	5.3	5.4	210
215	6.1	6	6.2	5.4	5.2	5.3	5.7	5.4	5.5	5.5	5.2	5.3	5.5	5.2	5.3	215
220	5.9	5.9	6.1	5.3	5.1	5.2	5.5	5.3	5.4	5.4	5.2	5.2	5.4	5.1	5.2	220
225	5.8	5.8	6.1	5.2	5	5.1	5.4	5.2	5.3	5.2	5.1	5.1	5.2	5	5.1	225
230	5.7	5.7	6	5.1	4.9	5	5.3	5.1	5.2	5.1	5	5.1	5.1	5	5	230
235	5.6	5.6	6	5	4.8	5	5.2	5	5.2	5	4.9	5	5	4.9	5	235
240	5.5	5.5	5.9	4.9	4.8	4.9	5.1	5	5.1	4.9	4.8	4.9	4.9	4.8	4.9	240
245	5.4	5.5	5.9	4.8	4.7	4.9	5	4.9	5.1	4.8	4.7	4.9	4.9	4.7	4.9	245
250	5.3	5.4	5.9	4.7	4.6	4.9	4.9	4.8	5	4.8	4.7	4.9	4.8	4.7	4.8	250
255	5.3	5.4		4.6	4.6	4.8	4.8	4.8	5	4.7	4.6	4.8	4.7	4.6	4.8	255
260	5.2	5.3		4.5	4.5		4.7	4.7	5	4.6	4.5	4.8	4.6	4.5	4.8	260
265	4.9	5.2		4.4	4.5		4.7	4.6	5	4.5	4.5	4.8	4.5	4.5	4.8	265
270	4.5	4.9		4.3	4.4		4.6	4.6		4.4	4.5	4.7	4.3	4.4	4.7	270
275	3.6			4.2	4.3		4.3	4.6		4.1	4.4		4	4.4		275
280				3.9	4.1		3.8	4.3		3.8	4.2		3.6	4.1		280
285				2.5			2.6	3.7		3.4	3.8		3.2	3.7		285
290										2.8	3.4		2.8	3.3		290
295														2.8		295

t\_259\_107\_23151 / 43151\_00\_000

# Lifting heights Hauteurs de levage

TVNZK

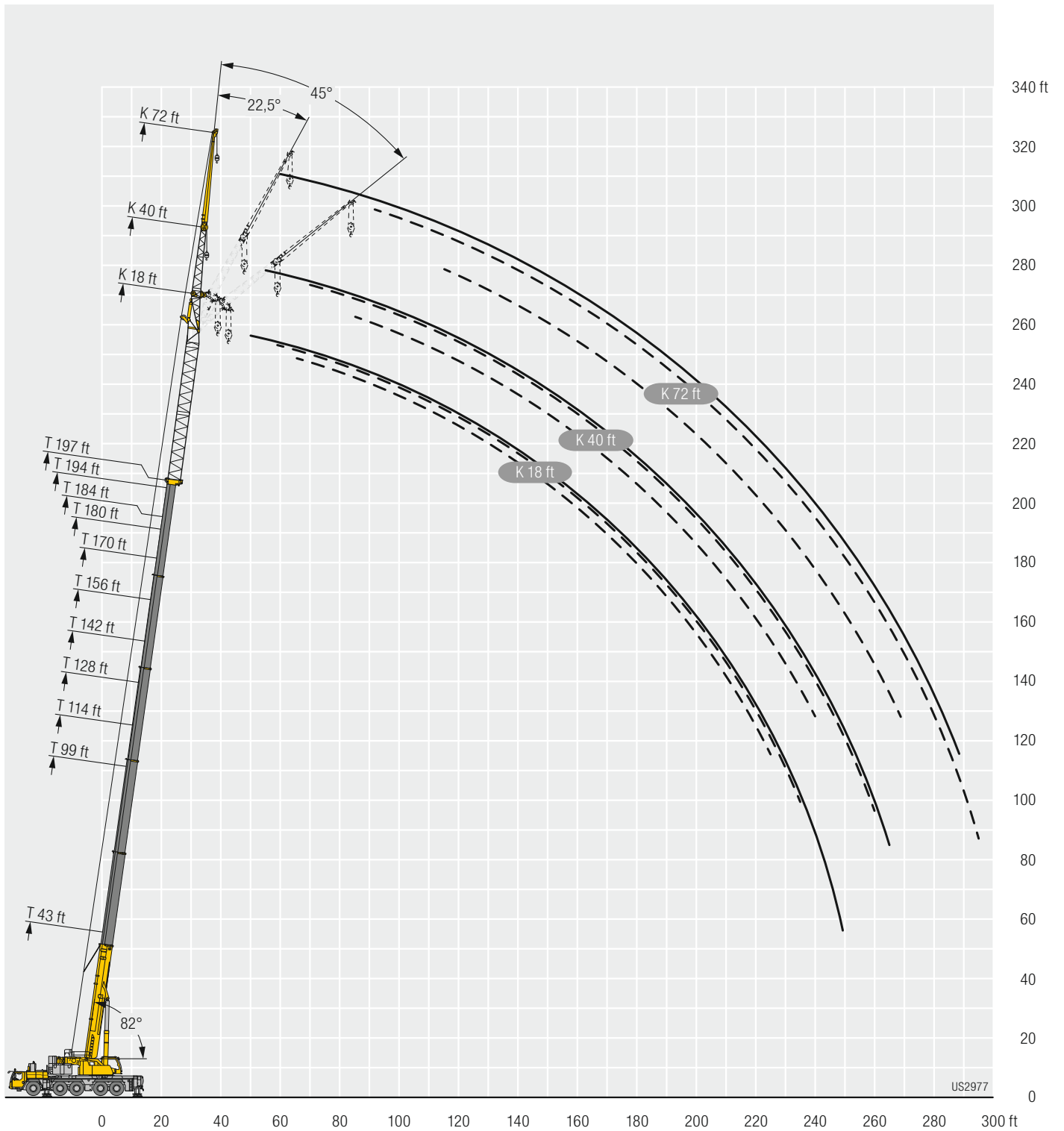

# Lifting capacities Forces de levage

TVNZK

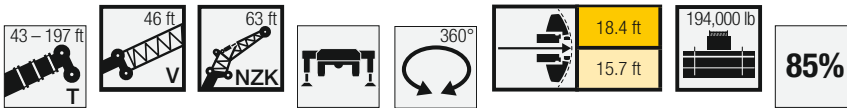

Lifting height (ft)	43 ft + 46 ft			99 ft + 46 ft			114 ft + 46 ft			128 ft + 46 ft			142 ft + 46 ft			156 ft + 46 ft			Lifting height (ft)
	63 ft																		
	0°	22,5°	45°	0°	22,5°	45°	0°	22,5°	45°	0°	22,5°	45°	0°	22,5°	45°	0°	22,5°	45°	
20	25.8																		20
22	25.8																		22
24	25.6																		24
26	25.1																		26
28	24.5																		28
30	23.9																		30
32	23.3			25.8															32
34	22.7			25.6			24.5												34
36	22.1			25.4			24.3			21.7									36
38	21.5			24.9			24.1			21.7									38
40	20.9			24.5			23.8			21.6			19.8						40
45	19.5	18.4		23.4			22.9			21.1			19.5			17.5			45
50	18.2	17.3		22.3			21.9			20.4			19			17.3			50
55	16.9	16.2		21.2			21			19.7			18.5			16.9			55
60	15.8	15.2		20.2	17.7		20	17.5		19			17.9			16.4			60
65	14.8	14.3	13.6	19.2	16.9		19.1	16.8		18.3	16.3		17.3			16			65
70	13.8	13.4	12.9	18.2	16.1		18.3	16.1		17.6	15.7		16.8	15.1		15.5	14.1		70
75	12.9	12.6	12.2	17.3	15.4	13.8	17.5	15.4	13.6	16.9	15.2		16.2	14.6		15.1	13.7		75
80	12.2	11.9	11.6	16.5	14.7	13.3	16.7	14.8	13.2	16.3	14.6	13.1	15.6	14.1		14.6	13.3		80
85	11.4	11.2	11	15.6	14.1	12.8	15.9	14.2	12.7	15.6	14	12.7	15.1	13.6	12.3	14.1	12.9		85
90	10.7	10.6	10.4	14.9	13.5	12.3	15.2	13.6	12.3	15	13.5	12.3	14.5	13.2	11.9	13.7	12.5	11.4	90
95	10.1	10	9.9	14.2	12.9	11.9	14.5	13.1	11.9	14.4	13	11.9	14	12.7	11.6	13.3	12.1	11.1	95
100	9.5	9.4	9.5	13.6	12.3	11.5	13.9	12.5	11.5	13.8	12.6	11.5	13.5	12.3	11.3	12.9	11.8	10.8	100
105	8.9	8.9	9	12.9	11.8	11.1	13.3	12	11.1	13.3	12.1	11.2	13	11.9	11	12.5	11.4	10.5	105
110	8.4	8.4	8.6	12.3	11.3	10.7	12.7	11.6	10.8	12.8	11.7	10.9	12.6	11.5	10.7	12.1	11.1	10.3	110
115	7.9	8	8.2	11.8	10.9	10.3	12.2	11.1	10.5	12.4	11.3	10.6	12.1	11.2	10.4	11.7	10.8	10	115
120	7.5	7.6	7.8	11.3	10.5	10	11.7	10.7	10.1	11.9	10.9	10.3	11.7	10.8	10.1	11.3	10.5	9.8	120
125	7.2	7.2	7.4	10.8	10.1	9.7	11.2	10.3	9.8	11.4	10.6	10	11.3	10.5	9.9	11	10.1	9.6	125
130	6.9	6.9	7.2	10.3	9.7	9.4	10.7	10	9.5	11	10.2	9.7	11	10.1	9.6	10.6	9.9	9.3	130
135	6.6	6.7	6.9	9.8	9.3	9.1	10.3	9.6	9.2	10.6	9.9	9.5	10.6	9.8	9.4	10.3	9.6	9.1	135
140	6.3	6.5		9.4	8.9	8.8	9.9	9.3	9	10.2	9.6	9.2	10.2	9.5	9.1	10	9.3	8.9	140
145	6.2			9	8.6	8.5	9.5	8.9	8.7	9.9	9.3	9	9.9	9.3	8.9	9.7	9.1	8.7	145
150				8.6	8.2	8.2	9.1	8.6	8.4	9.5	9	8.7	9.6	9	8.7	9.4	8.8	8.5	150
155				8.2	7.9	8	8.7	8.3	8.2	9.2	8.7	8.5	9.3	8.7	8.5	9.1	8.6	8.3	155
160				7.9	7.7	7.7	8.3	8	8	8.9	8.4	8.3	9	8.5	8.3	8.9	8.3	8.2	160
165				7.6	7.4	7.5	8	7.7	7.8	8.6	8.2	8.1	8.7	8.2	8.1	8.6	8.1	8	165
170				7.3	7.2	7.4	7.8	7.5	7.6	8.3	7.9	7.9	8.4	8	8	8.4	7.9	7.8	170
175				7.1	7		7.5	7.3	7.4	8	7.7	7.8	8.2	7.8	7.8	8.1	7.7	7.7	175
180				6.9	6.8		7.2	7.1	7.3	7.8	7.5	7.6	7.9	7.6	7.6	7.9	7.5	7.6	180
185				6.7	6.7		7	6.9		7.5	7.3	7.4	7.7	7.4	7.5	7.7	7.4	7.4	185
190				6.5	6.5		6.8	6.8		7.3	7.1	7.3	7.4	7.2	7.3	7.5	7.2	7.3	190
195				6.3	6.4		6.6	6.6		7.1	7	7.2	7.2	7.1	7.2	7.3	7	7.2	195
200				6.2			6.4	6.5		6.9	6.8		7.1	6.9	7.1	7.1	6.9	7.1	200
205							6.3	6.4		6.7	6.7		6.9	6.8	7	6.9	6.8	7	205
210							6.2	6.3		6.6	6.5		6.7	6.6		6.8	6.6	6.9	210
215							6.1			6.4	6.4		6.6	6.5		6.6	6.5	6.8	215
220										6.2	6.3		6.4	6.4		6.5	6.4	6.7	220
225										6.1	6.3		6.3	6.3		6.3	6.3	6.7	225
230										5.1			6.2	6.2		6.2	6.2		230
235													6.1	6.2		6.1	6.2		235
240													5.3			6	6.1		240
245													3.3			5.9	6		245
250																5.6	6		250
255																4.5			255

t\_259\_107\_22151 / 42151\_00\_000

# Lifting capacities Forces de levage

TVNZK

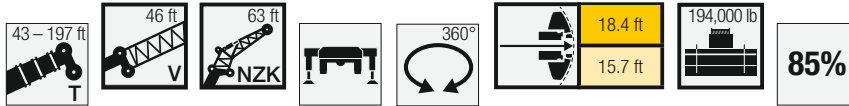

Lifting height (ft)	170 ft + 46 ft			180 ft + 46 ft			184 ft + 46 ft			194 ft + 46 ft			197 ft + 46 ft			Lifting height (ft)
	0°	22,5°	45°	0°	22,5°	45°	63 ft			0°	22,5°	45°	0°	22,5°	45°	
50	15.1															50
55	14.9			12.4			12.6									55
60	14.5			12.2			12.4			11.2			11			60
65	14.2			12			12.2			11			10.8			65
70	13.9			11.7			12			10.9			10.7			70
75	13.5	12.5		11.5			11.7			10.7			10.5			75
80	13.2	12.2		11.3	10.6		11.5			10.5			10.3			80
85	12.9	11.9		11	10.4		11.3	10.6		10.3	9.8		10.1	9.7		85
90	12.5	11.6		10.8	10.2		11	10.4		10.1	9.6		10	9.5		90
95	12.2	11.3	10.4	10.6	10		10.8	10.1		9.9	9.4		9.8	9.3		95
100	11.8	11	10.2	10.3	9.7	9.2	10.5	9.9	9.3	9.7	9.3		9.6	9.1		100
105	11.5	10.7	9.9	10.1	9.5	9	10.3	9.7	9.1	9.5	9.1	8.6	9.4	9	8.5	105
110	11.2	10.4	9.7	9.9	9.3	8.8	10.1	9.5	8.9	9.3	8.9	8.5	9.2	8.8	8.4	110
115	10.9	10.1	9.5	9.6	9.1	8.7	9.8	9.3	8.8	9.1	8.7	8.3	9	8.6	8.2	115
120	10.6	9.9	9.3	9.4	8.9	8.5	9.6	9.1	8.6	8.9	8.5	8.2	8.8	8.4	8.1	120
125	10.3	9.6	9.1	9.2	8.6	8.2	9.4	8.9	8.4	8.7	8.3	8	8.7	8.3	7.9	125
130	10	9.4	8.9	9	8.4	8	9.1	8.6	8.2	8.6	8.2	7.9	8.5	8.1	7.8	130
135	9.7	9.1	8.7	8.7	8.1	7.8	8.9	8.4	8	8.4	8	7.7	8.3	7.9	7.6	135
140	9.5	8.9	8.6	8.5	7.8	7.6	8.7	8.1	7.8	8.2	7.8	7.5	8.1	7.7	7.5	140
145	9.2	8.7	8.4	8.3	7.6	7.4	8.5	7.9	7.6	8	7.6	7.3	8	7.5	7.3	145
150	9	8.5	8.2	8.1	7.4	7.2	8.3	7.7	7.5	7.9	7.4	7.2	7.8	7.4	7.1	150
155	8.7	8.3	8	7.8	7.2	7	8.1	7.5	7.3	7.7	7.2	7	7.6	7.2	7	155
160	8.5	8.1	7.9	7.6	7	6.9	7.9	7.3	7.1	7.5	7	6.9	7.5	7	6.9	160
165	8.3	7.9	7.7	7.3	6.9	6.7	7.6	7.1	7	7.3	6.9	6.7	7.3	6.8	6.7	165
170	8.1	7.7	7.6	7.1	6.7	6.6	7.4	7	6.8	7.1	6.7	6.6	7.1	6.7	6.6	170
175	7.8	7.5	7.5	7	6.6	6.5	7.3	6.8	6.7	7	6.6	6.5	7	6.5	6.4	175
180	7.6	7.4	7.4	6.8	6.4	6.3	7.1	6.7	6.6	6.8	6.4	6.3	6.8	6.4	6.3	180
185	7.5	7.2	7.2	6.6	6.3	6.2	6.9	6.5	6.5	6.6	6.3	6.2	6.6	6.3	6.2	185
190	7.3	7.1	7.1	6.4	6.1	6.1	6.7	6.4	6.3	6.5	6.1	6.1	6.5	6.1	6.1	190
195	7.1	6.9	7	6.3	6	6	6.6	6.2	6.2	6.3	6	6	6.3	6	6	195
200	7	6.8	6.9	6.1	5.9	5.9	6.4	6.1	6.1	6.2	5.9	5.9	6.2	5.9	5.9	200
205	6.8	6.7	6.8	6	5.7	5.8	6.3	6	6	6	5.8	5.8	6.1	5.8	5.8	205
210	6.7	6.5	6.8	5.8	5.6	5.7	6.1	5.9	5.9	5.9	5.7	5.7	5.9	5.7	5.7	210
215	6.5	6.4	6.7	5.7	5.5	5.6	6	5.8	5.8	5.8	5.6	5.6	5.8	5.6	5.6	215
220	6.4	6.3	6.6	5.6	5.4	5.5	5.8	5.6	5.7	5.7	5.5	5.5	5.7	5.5	5.5	220
225	6.3	6.2	6.6	5.5	5.3	5.4	5.7	5.5	5.7	5.5	5.4	5.5	5.6	5.4	5.5	225
230	6.2	6.2	6.5	5.4	5.2	5.4	5.6	5.5	5.6	5.4	5.3	5.4	5.5	5.3	5.4	230
235	6.1	6.1	6.5	5.3	5.2	5.4	5.5	5.4	5.5	5.3	5.2	5.3	5.4	5.2	5.3	235
240	6	6	6.5	5.2	5.1	5.3	5.4	5.3	5.5	5.2	5.1	5.3	5.3	5.1	5.3	240
245	5.9	5.9		5.1	5	5.3	5.3	5.2	5.4	5.1	5	5.2	5.2	5	5.2	245
250	5.7	5.9		4.9	5		5.2	5.1	5.4	5.1	5	5.2	5	5	5.2	250
255	5.3	5.6		4.8	4.9		5.1	5.1		5	4.9	5.1	4.9	4.9	5.1	255
260	5	5.2		4.6	4.7		5	5		4.8	4.9	5	4.8	4.9	5	260
265	4.3	5		4.5			4.7	5		4.6	4.8		4.4	4.7		265
270				4.3			4.3	4.7		4.2	4.6		4	4.4		270
275				3.3			3.3	4.2		3.8			3.6	4		275
280										3.4			3.2			280
285													2.4			285

t\_259\_107\_22151 / 42151\_00\_000

# Lifting capacities Forces de levage

TVNZK

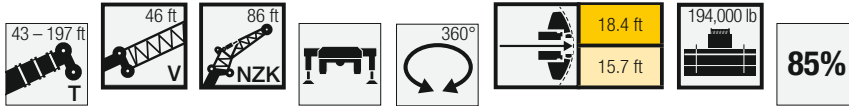

Jib height (ft)	43 ft + 46 ft			99 ft + 46 ft			114 ft + 46 ft			128 ft + 46 ft			142 ft + 46 ft			156 ft + 46 ft			Jib height (ft)
	0°	22,5°	45°	0°	22,5°	45°	0°	22,5°	45°	0°	22,5°	45°	0°	22,5°	45°	0°	22,5°	45°	
24	16.5																		24
26	16.4																		26
28	16.3																		28
30	16.2																		30
32	16.1																		32
34	16			16.5															34
36	15.9			16.4			15.7												36
38	15.8			16.3			15.6												38
40	15.7			16.2			15.5			14.6									40
45	15			16.1			15.4			14.4			13.3						45
50	14.3			15.9			15.2			14.3			13.2			11.9			50
55	13.5			15.6			15			14.1			13.1			11.8			55
60	12.7	12.2		15.2			14.8			14			13			11.7			60
65	12	11.6		14.6			14.3			13.8			12.8			11.6			65
70	11.3	11.1		14	12.3		13.8			13.3			12.6			11.5			70
75	10.6	10.5		13.4	11.9		13.3	11.8		12.9			12.3			11.3			75
80	10	10	8.3	12.8	11.5		12.8	11.4		12.4	11.2		11.9	10.6		11			80
85	9.5	9.4	8.1	12.3	11.1		12.3	11		12	10.8		11.5	10.3		10.7	9.7		85
90	8.9	8.9	7.9	11.7	10.7		11.8	10.6		11.6	10.4		11.1	10		10.4	9.4		90
95	8.4	8.4	7.7	11.2	10.2	8.2	11.3	10.2	8.2	11.1	10		10.7	9.7		10.1	9.2		95
100	7.9	7.9	7.6	10.7	9.8	8	10.9	9.8	8	10.7	9.7	7.9	10.4	9.4		9.8	8.9		100
105	7.5	7.5	7.4	10.2	9.4	7.9	10.4	9.4	7.9	10.3	9.3	7.8	10	9.1	7.7	9.5	8.6		105
110	7.1	7.2	7.1	9.8	9	7.8	10	9.1	7.7	9.9	9	7.7	9.7	8.8	7.6	9.2	8.4	7.4	110
115	6.8	6.8	6.8	9.4	8.7	7.6	9.6	8.7	7.6	9.5	8.7	7.6	9.3	8.5	7.5	8.9	8.1	7.3	115
120	6.4	6.5	6.6	9	8.3	7.5	9.2	8.4	7.5	9.2	8.4	7.5	9	8.2	7.4	8.6	7.9	7.2	120
125	6.1	6.2	6.3	8.6	8	7.4	8.8	8.1	7.4	8.8	8.1	7.4	8.7	7.9	7.3	8.3	7.7	7	125
130	5.8	5.9	6.1	8.2	7.7	7.2	8.5	7.8	7.3	8.5	7.8	7.2	8.4	7.7	7.1	8.1	7.4	6.9	130
135	5.6	5.7	5.9	7.8	7.4	7	8.1	7.5	7.1	8.2	7.5	7	8.1	7.5	6.9	7.8	7.2	6.8	135
140	5.3	5.4	5.6	7.5	7.1	6.8	7.8	7.3	6.9	7.9	7.3	6.9	7.8	7.2	6.8	7.6	7.1	6.6	140
145	5	5.2	5.4	7.3	6.9	6.7	7.5	7	6.7	7.6	7.1	6.7	7.6	7	6.6	7.4	6.9	6.5	145
150	4.9	5	5.2	7	6.7	6.5	7.2	6.8	6.5	7.4	6.9	6.5	7.3	6.9	6.5	7.2	6.7	6.3	150
155	4.6	4.8	5.1	6.7	6.4	6.3	7	6.6	6.4	7.1	6.7	6.4	7.1	6.7	6.4	7	6.6	6.2	155
160	4.5	4.6		6.5	6.2	6.2	6.7	6.4	6.2	6.9	6.5	6.3	6.9	6.5	6.2	6.8	6.4	6.1	160
165	4.3	4.5		6.2	6	6	6.5	6.2	6.1	6.7	6.3	6.1	6.7	6.3	6.1	6.6	6.2	6	165
170				6	5.8	5.8	6.3	6	6	6.4	6.1	6	6.5	6.1	6	6.4	6.1	5.9	170
175				5.8	5.6	5.7	6	5.8	5.8	6.2	6	5.9	6.3	6	5.9	6.2	5.9	5.8	175
180				5.6	5.5	5.5	5.8	5.7	5.7	6	5.8	5.7	6.1	5.8	5.7	6	5.8	5.6	180
185				5.4	5.3	5.4	5.7	5.5	5.6	5.8	5.6	5.6	5.9	5.7	5.6	5.9	5.6	5.5	185
190				5.2	5.1	5.3	5.5	5.4	5.4	5.6	5.5	5.5	5.7	5.5	5.5	5.7	5.5	5.4	190
195				5	5	5.2	5.3	5.2	5.3	5.5	5.3	5.4	5.6	5.4	5.4	5.5	5.3	5.3	195
200				4.9	4.8		5.1	5	5.2	5.3	5.2	5.3	5.4	5.2	5.3	5.4	5.2	5.2	200
205				4.7	4.7		4.9	4.9	5.1	5.1	5	5.2	5.2	5.1	5.2	5.3	5.1	5.1	205
210				4.6	4.6		4.8	4.8	5	5	4.9	5.1	5.1	5	5.1	5.1	5	5.1	210
215				4.4	4.5		4.6	4.7		4.8	4.8	5	4.9	4.9	5	5	4.9	5	215
220				4.3			4.5	4.6		4.7	4.7	4.9	4.8	4.7	4.9	4.8	4.8	4.9	220
225				4.2			4.4	4.5		4.6	4.6		4.7	4.6	4.9	4.7	4.6	4.8	225
230							4.3	4.4		4.4	4.5		4.6	4.5	4.8	4.6	4.5	4.8	230
235							4.2			4.3	4.4		4.4	4.5		4.5	4.5	4.7	235
240							2.6			4.2	4.3		4.3	4.4		4.4	4.4	4.7	240
245										4.1	4.3		4.2	4.3		4.3	4.3	4.7	245
250										4			4.1	4.2		4.2	4.2	4.7	250
255													4.1	4.2		4.1	4.2		255
260													4	4.2		4	4.1		260
265													3.4			4	4.1		265
270																3.9	4.1		270
275																3.4			275

t\_259\_107\_24151 / 44151\_00\_000



# Lifting capacities Forces de levage

TVNZK

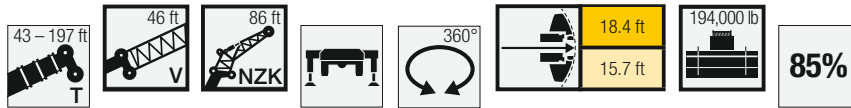

Jib height (ft)	170 ft + 46 ft			180 ft + 46 ft			184 ft + 46 ft			194 ft + 46 ft			197 ft + 46 ft			Jib height (ft)
	0°	22,5°	45°	0°	22,5°	45°	86 ft			0°	22,5°	45°	0°	22,5°	45°	
55	10.4															55
60	10.3			8.6			8.7									60
65	10.2			8.5			8.7			7.7			7.6			65
70	10.2			8.5			8.6			7.7			7.6			70
75	10.1			8.4			8.6			7.6			7.5			75
80	9.9			8.2			8.5			7.5			7.4			80
85	9.6			8.1			8.3			7.4			7.3			85
90	9.4	8.6		8			8.2			7.3			7.2			90
95	9.1	8.4		7.8	7.2		8	7.3		7.3			7.1			95
100	8.9	8.2		7.7	7.1		7.8	7.3		7.2	6.5		7	6.4		100
105	8.7	8		7.5	7.1		7.6	7.2		7.1	6.5		7	6.4		105
110	8.4	7.8		7.3	7		7.5	7.1		7	6.5		6.9	6.4		110
115	8.2	7.5	7	7.2	6.8		7.3	6.9		6.8	6.5		6.8	6.4		115
120	8	7.4	6.8	7.1	6.7	6.2	7.2	6.8	6.2	6.7	6.4		6.6	6.3		120
125	7.7	7.2	6.7	6.9	6.6	6.2	7	6.6	6.2	6.6	6.3	5.7	6.5	6.2	5.5	125
130	7.5	7	6.6	6.8	6.4	6.1	6.9	6.5	6.2	6.5	6.2	5.7	6.4	6.1	5.5	130
135	7.3	6.9	6.4	6.6	6.3	6	6.7	6.4	6.1	6.3	6.1	5.7	6.3	6	5.5	135
140	7.2	6.7	6.3	6.5	6.2	5.9	6.6	6.2	5.9	6.2	5.9	5.7	6.1	5.9	5.5	140
145	7	6.6	6.2	6.3	6	5.8	6.4	6.1	5.8	6.1	5.8	5.6	6	5.8	5.5	145
150	6.8	6.4	6.1	6.2	5.9	5.7	6.3	6	5.7	5.9	5.7	5.5	5.9	5.7	5.5	150
155	6.6	6.3	6	6.1	5.7	5.5	6.1	5.9	5.6	5.8	5.6	5.4	5.8	5.5	5.4	155
160	6.5	6.1	5.9	5.9	5.6	5.4	6	5.7	5.5	5.7	5.5	5.3	5.7	5.4	5.3	160
165	6.3	6	5.8	5.8	5.4	5.2	5.9	5.6	5.4	5.6	5.4	5.2	5.5	5.3	5.2	165
170	6.1	5.8	5.7	5.6	5.3	5.1	5.7	5.5	5.3	5.5	5.2	5.1	5.4	5.2	5.1	170
175	6	5.7	5.6	5.5	5.1	5	5.6	5.3	5.2	5.4	5.1	5	5.3	5.1	5	175
180	5.8	5.6	5.5	5.4	5	4.9	5.5	5.2	5.1	5.2	5	4.9	5.2	5	4.9	180
185	5.7	5.4	5.4	5.2	4.9	4.8	5.4	5.1	5	5.1	4.9	4.8	5.1	4.9	4.8	185
190	5.5	5.3	5.3	5.1	4.8	4.7	5.2	4.9	4.9	5	4.7	4.7	5	4.7	4.7	190
195	5.4	5.2	5.2	4.9	4.6	4.6	5.1	4.8	4.7	4.9	4.6	4.6	4.9	4.6	4.6	195
200	5.3	5.1	5.1	4.8	4.5	4.5	5	4.7	4.6	4.8	4.5	4.5	4.8	4.5	4.5	200
205	5.1	5	5	4.7	4.4	4.4	4.9	4.6	4.6	4.7	4.4	4.4	4.7	4.4	4.4	205
210	5	4.9	5	4.6	4.3	4.3	4.8	4.5	4.5	4.6	4.3	4.3	4.6	4.3	4.3	210
215	4.9	4.8	4.9	4.4	4.2	4.2	4.6	4.4	4.4	4.5	4.2	4.2	4.5	4.2	4.2	215
220	4.8	4.7	4.8	4.3	4.1	4.1	4.5	4.3	4.3	4.3	4.1	4.1	4.4	4.1	4.1	220
225	4.6	4.6	4.7	4.2	4	4.1	4.4	4.2	4.2	4.2	4	4.1	4.3	4	4.1	225
230	4.5	4.5	4.7	4.1	3.9	4	4.3	4.1	4.2	4.1	3.9	4	4.2	3.9	4	230
235	4.4	4.4	4.6	4	3.8	3.9	4.2	4	4.1	4	3.9	3.9	4.1	3.9	3.9	235
240	4.3	4.3	4.6	3.9	3.7	3.8	4.1	3.9	4	4	3.8	3.9	4	3.8	3.9	240
245	4.2	4.2	4.5	3.8	3.7	3.8	4	3.8	4	3.9	3.7	3.8	3.9	3.7	3.8	245
250	4.2	4.2	4.5	3.7	3.6	3.7	3.9	3.8	3.9	3.8	3.6	3.8	3.8	3.6	3.8	250
255	4.1	4.1	4.5	3.6	3.5	3.7	3.8	3.7	3.9	3.7	3.5	3.7	3.7	3.6	3.7	255
260	4	4.1	4.5	3.5	3.5	3.7	3.7	3.6	3.9	3.6	3.5	3.7	3.6	3.5	3.7	260
265	4	4	4.5	3.5	3.4	3.7	3.6	3.6	3.8	3.5	3.4	3.6	3.5	3.4	3.6	265
270	3.9	4		3.4	3.3	3.7	3.6	3.5	3.8	3.5	3.4	3.6	3.5	3.4	3.6	270
275	3.8	4		3.3	3.3	3.7	3.5	3.5	3.8	3.4	3.3	3.6	3.4	3.3	3.6	275
280	3.4	3.9		3.3	3.3		3.4	3.4		3.3	3.3	3.6	3.2	3.3	3.6	280
285	3.2			3.2	3.3		3.3	3.4		3.1	3.3		2.9	3.3	3.5	285
290				3	3.2		2.9	3.3		2.7	3.2		2.6	3.1		290
295				2.3				3		2.4	2.9		2.2	2.8		295
300											2.5					300

t\_259\_107\_24151 / 44151\_00\_000

# Lifting heights Hauteurs de levage

TVNZK

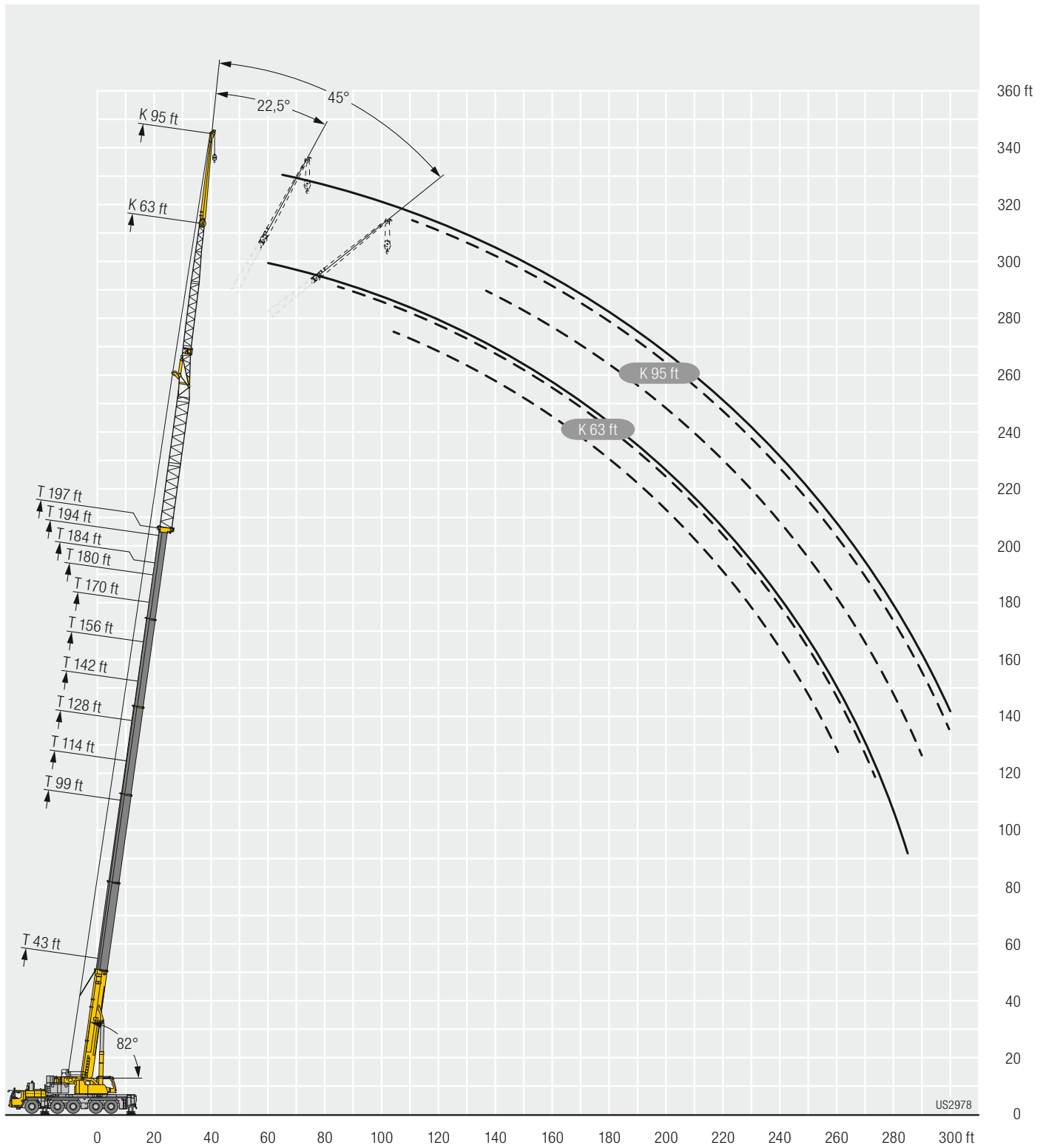

# Lifting capacities Forces de levage

TVNZK

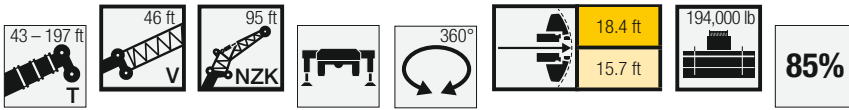

Jib Length	43 ft + 46 ft			99 ft + 46 ft			114 ft + 46 ft			128 ft + 46 ft			142 ft + 46 ft			156 ft + 46 ft			Jib Length
	0°	22.5°	45°	0°	22.5°	45°	0°	22.5°	45°	0°	22.5°	45°	0°	22.5°	45°	0°	22.5°	45°	
24	12.4																		24
26	12.3																		26
28	12.3																		28
30	12.2																		30
32	12.2																		32
34	12.1																		34
36	12			12.3															36
38	12			12.3			11.8												38
40	11.9			12.2			11.8			11.2									40
45	11.8			12.1			11.7			11.2			10.5						45
50	11.6			12			11.6			11.1			10.4			9.5			50
55	11.4			11.9			11.5			11			10.3			9.5			55
60	11.1			11.8			11.4			10.9			10.2			9.4			60
65	10.6	9.8		11.6			11.3			10.8			10.1			9.3			65
70	10.1	9.4		11.5			11.1			10.7			10			9.3			70
75	9.6	9.1		11.4	9.9		11			10.6			10			9.2			75
80	9.2	8.7		11.1	9.6		10.9	9.5		10.4			9.9			9.1			80
85	8.7	8.4		10.7	9.3		10.6	9.2		10.3	9.1		9.8	8.8		9			85
90	8.2	8.1	6.9	10.3	9		10.3	9		10	8.9		9.6	8.6		9	8.3		90
95	7.8	7.8	6.7	10	8.8		10	8.7		9.7	8.6		9.4	8.4		8.8	8.1		95
100	7.5	7.5	6.6	9.6	8.5	6.9	9.6	8.5		9.4	8.4		9.1	8.2		8.6	7.9		100
105	7.1	7.2	6.5	9.2	8.3	6.8	9.3	8.3	6.7	9.1	8.2		8.8	8		8.4	7.8		105
110	6.8	6.9	6.4	8.9	8.1	6.7	8.9	8.1	6.6	8.8	8	6.6	8.6	7.9	6.5	8.1	7.6		110
115	6.5	6.6	6.3	8.5	7.9	6.6	8.6	7.9	6.6	8.6	7.8	6.5	8.3	7.7	6.4	7.9	7.4	6.3	115
120	6.2	6.3	6.2	8.2	7.7	6.5	8.3	7.7	6.5	8.3	7.7	6.4	8.1	7.5	6.4	7.7	7.2	6.3	120
125	5.9	6.1	6.1	7.9	7.4	6.4	8	7.5	6.4	8	7.4	6.4	7.8	7.3	6.3	7.5	7.1	6.2	125
130	5.6	5.8	5.9	7.6	7.2	6.3	7.7	7.3	6.3	7.7	7.3	6.3	7.6	7.1	6.2	7.3	6.9	6.1	130
135	5.4	5.5	5.7	7.3	7	6.3	7.5	7.1	6.3	7.5	7.1	6.2	7.4	7	6.2	7.1	6.7	6.1	135
140	5.1	5.3	5.5	7	6.8	6.2	7.2	6.9	6.2	7.3	6.9	6.2	7.2	6.8	6.1	7	6.6	6	140
145	4.9	5	5.3	6.8	6.5	6.2	7	6.7	6.1	7	6.7	6.1	7	6.6	6.1	6.8	6.4	6	145
150	4.7	4.8	5.1	6.6	6.3	6.1	6.8	6.5	6.1	6.8	6.5	6.1	6.8	6.4	6	6.6	6.3	5.9	150
155	4.5	4.6	4.9	6.3	6.1	6	6.5	6.3	6	6.6	6.3	6	6.6	6.3	5.9	6.4	6.1	5.8	155
160	4.3	4.5	4.7	6.1	5.9	5.8	6.3	6.1	5.9	6.4	6.1	5.9	6.4	6.1	5.8	6.2	6	5.7	160
165	4.1	4.3	4.6	5.9	5.7	5.7	6.1	5.9	5.8	6.2	5.9	5.8	6.2	5.9	5.7	6.1	5.8	5.6	165
170	4	4.1		5.7	5.6	5.5	5.9	5.7	5.6	6	5.8	5.6	6	5.8	5.6	5.9	5.7	5.5	170
175	3.8	4.1		5.5	5.4	5.4	5.7	5.5	5.5	5.8	5.6	5.5	5.8	5.6	5.5	5.8	5.5	5.4	175
180				5.3	5.2	5.3	5.5	5.4	5.4	5.6	5.5	5.4	5.7	5.5	5.4	5.6	5.4	5.3	180
185				5.1	5	5.1	5.3	5.2	5.2	5.5	5.3	5.3	5.5	5.3	5.3	5.5	5.3	5.2	185
190				4.9	4.9	5	5.1	5.1	5.1	5.3	5.1	5.2	5.4	5.2	5.2	5.3	5.1	5.1	190
195				4.8	4.8	4.9	5	4.9	5	5.2	5	5	5.2	5	5.1	5.2	5	5	195
200				4.6	4.6	4.8	4.8	4.8	4.9	5	4.9	4.9	5.1	4.9	5	5	4.9	4.9	200
205				4.5	4.5	4.7	4.7	4.7	4.8	4.8	4.8	4.9	4.9	4.8	4.9	4.9	4.8	4.8	205
210				4.3	4.4		4.5	4.5	4.7	4.7	4.6	4.8	4.8	4.7	4.8	4.8	4.7	4.7	210
215				4.2	4.2		4.4	4.4	4.6	4.6	4.5	4.7	4.7	4.6	4.7	4.7	4.6	4.6	215
220				4.1	4.1		4.3	4.3		4.4	4.4	4.6	4.5	4.5	4.6	4.5	4.5	4.6	220
225				3.9	4.1		4.2	4.2		4.3	4.3	4.5	4.4	4.4	4.5	4.4	4.4	4.5	225
230				3.8			4.1	4.1		4.2	4.2		4.3	4.3	4.5	4.3	4.3	4.4	230
235				3.8			4	4		4.1	4.1		4.2	4.2	4.4	4.2	4.2	4.4	235
240							3.9			4	4		4.1	4.1	4.4	4.1	4.1	4.3	240
245							3.8			3.9	4		4	4		4	4	4.3	245
250										3.8	3.9		3.9	4		3.9	3.9	4.3	250
255										3.7			3.8	3.9		3.8	3.9	4.3	255
260										3.2			3.7	3.9		3.8	3.8	4.3	260
265													3.7	3.8		3.7	3.8		265
270													3.6			3.6	3.7		270
275													3.1			3.5	3.7		275
280																3.5	3.7		280
285																3.1			285

t\_259\_107\_25151 / 45151\_00\_000

# Lifting capacities Forces de levage

TVNZK

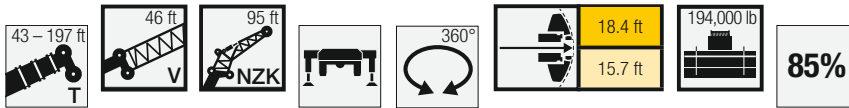

Lifting hook icon	170 ft + 46 ft			180 ft + 46 ft			184 ft + 46 ft			194 ft + 46 ft			197 ft + 46 ft			Lifting hook icon
	0°	22,5°	45°	0°	22,5°	45°	95 ft			0°	22,5°	45°	0°	22,5°	45°	
55	8.5															55
60	8.4			7.2			7.3									60
65	8.4			7.2			7.3			6.7			6.5			65
70	8.3			7.1			7.2			6.6			6.5			70
75	8.3			7.1			7.2			6.6			6.5			75
80	8.2			7.1			7.2			6.6			6.5			80
85	8.1			7.1			7.1			6.5			6.4			85
90	8.1			7			7.1			6.5			6.4			90
95	8			6.9			7.1			6.4			6.3			95
100	7.8	7.5		6.9			7			6.4			6.2			100
105	7.7	7.3		6.8	6.3		6.9	6.5		6.3	5.7		6.2			105
110	7.5	7.1		6.7	6.2		6.8	6.5		6.2	5.7		6.1	5.6		110
115	7.3	7		6.5	6.2		6.6	6.4		6.2	5.7		6.1	5.6		115
120	7.2	6.8		6.4	6.2		6.5	6.3		6.1	5.7		6	5.6		120
125	7	6.7	6	6.3	6.1		6.4	6.2		6	5.7		5.9	5.6		125
130	6.9	6.5	6	6.2	6	5.5	6.3	6	5.6	5.9	5.7		5.8	5.6		130
135	6.7	6.4	5.9	6	5.9	5.5	6.1	5.9	5.6	5.8	5.6	5	5.7	5.6	4.9	135
140	6.6	6.2	5.9	5.9	5.7	5.4	6	5.8	5.5	5.7	5.5	5	5.6	5.5	4.9	140
145	6.4	6.1	5.8	5.8	5.6	5.4	5.9	5.7	5.4	5.6	5.4	5	5.5	5.4	4.9	145
150	6.3	6	5.7	5.7	5.5	5.3	5.8	5.6	5.3	5.5	5.3	5	5.4	5.3	4.9	150
155	6.1	5.8	5.6	5.6	5.4	5.2	5.7	5.5	5.2	5.4	5.2	5	5.3	5.2	4.9	155
160	6	5.7	5.5	5.5	5.3	5.1	5.5	5.3	5.2	5.2	5.1	5	5.2	5.1	4.9	160
165	5.8	5.6	5.4	5.3	5.2	5	5.4	5.2	5.1	5.1	5	4.9	5.1	5	4.8	165
170	5.7	5.5	5.3	5.2	5	4.9	5.3	5.1	5	5	4.9	4.8	5	4.9	4.8	170
175	5.5	5.3	5.2	5.1	4.9	4.8	5.2	5	4.9	4.9	4.8	4.7	4.9	4.8	4.7	175
180	5.4	5.2	5.1	5	4.8	4.7	5.1	4.9	4.8	4.8	4.7	4.6	4.8	4.7	4.6	180
185	5.3	5.1	5	4.9	4.6	4.6	5	4.8	4.7	4.7	4.6	4.5	4.7	4.6	4.5	185
190	5.2	5	4.9	4.8	4.5	4.4	4.9	4.7	4.6	4.7	4.5	4.4	4.6	4.5	4.4	190
195	5	4.9	4.9	4.6	4.4	4.3	4.8	4.6	4.5	4.6	4.4	4.3	4.5	4.4	4.3	195
200	4.9	4.8	4.8	4.5	4.3	4.2	4.7	4.5	4.4	4.5	4.3	4.2	4.4	4.3	4.2	200
205	4.8	4.7	4.7	4.4	4.2	4.2	4.6	4.4	4.3	4.4	4.2	4.2	4.4	4.2	4.2	205
210	4.7	4.6	4.6	4.3	4.1	4.1	4.4	4.3	4.2	4.3	4.1	4.1	4.3	4.1	4.1	210
215	4.6	4.5	4.6	4.2	4	4	4.4	4.2	4.2	4.2	4	4	4.2	4	4	215
220	4.5	4.4	4.5	4.1	3.9	3.9	4.3	4.1	4.1	4.1	3.9	3.9	4.1	3.9	3.9	220
225	4.3	4.3	4.4	4	3.8	3.8	4.2	4	4	4	3.8	3.8	4	3.8	3.8	225
230	4.2	4.2	4.4	3.9	3.7	3.8	4.1	3.9	3.9	3.9	3.7	3.8	3.9	3.7	3.8	230
235	4.2	4.1	4.3	3.8	3.6	3.7	4	3.8	3.8	3.8	3.7	3.7	3.8	3.7	3.7	235
240	4.1	4	4.2	3.7	3.5	3.6	3.9	3.7	3.8	3.8	3.6	3.7	3.8	3.6	3.6	240
245	4	4	4.2	3.6	3.5	3.6	3.8	3.6	3.7	3.7	3.5	3.6	3.7	3.5	3.6	245
250	3.9	3.9	4.2	3.5	3.4	3.5	3.7	3.5	3.7	3.6	3.4	3.5	3.6	3.4	3.5	250
255	3.8	3.8	4.1	3.4	3.3	3.5	3.6	3.5	3.6	3.5	3.4	3.5	3.5	3.4	3.5	255
260	3.7	3.8	4.1	3.4	3.3	3.4	3.5	3.4	3.6	3.4	3.3	3.4	3.4	3.3	3.4	260
265	3.7	3.7	4.1	3.3	3.2	3.4	3.5	3.4	3.5	3.3	3.2	3.4	3.3	3.2	3.4	265
270	3.6	3.7	4.1	3.2	3.2	3.4	3.4	3.3	3.5	3.3	3.2	3.4	3.3	3.2	3.4	270
275	3.5	3.6		3.2	3.1	3.4	3.3	3.3	3.5	3.2	3.1	3.4	3.2	3.1	3.3	275
280	3.5	3.6		3.1	3.1	3.4	3.2	3.2	3.5	3.1	3.1	3.3	3.2	3.1	3.3	280
285	3.4	3.6		3	3		3.2	3.2	3.5	3.1	3	3.3	3	3	3.3	285
290	3.1	3.5		3	3		3.1	3.1		3	3		2.8	3	3.3	290
295	2.7			2.9	3		2.9	3.1		2.7	3		2.5	3		295
300				2.7	2.9		2.5	3		2.4	2.9			2.8		300
305								2.6								305
310																310

L\_259\_107\_25151 / 45151\_00\_000

# Lifting capacities Forces de levage

**TVNZK**

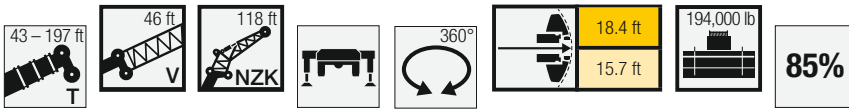

Jib Length (ft)	43 ft + 46 ft			99 ft + 46 ft			114 ft + 46 ft			128 ft + 46 ft			142 ft + 46 ft			156 ft + 46 ft			Jib Length (ft)
	0°	22.5°	45°	0°	22.5°	45°	0°	22.5°	45°	0°	22.5°	45°	0°	22.5°	45°	0°	22.5°	45°	
28	8.8																		28
30	8.8																		30
32	8.7																		32
34	8.7																		34
36	8.6																		36
38	8.6																		38
40	8.5			8.8															40
45	8.4			8.7		8			7.8										45
50	8.3			8.6		8			7.8			7.2							50
55	8.1			8.5		8			7.7			7.2			6.6				55
60	8			8.4		8			7.7			7.2			6.6				60
65	7.8			8.3		8			7.6			7.2			6.6				65
70	7.6			8.2		7.9			7.5			7.1			6.6				70
75	7.3	6.4		8.1		7.8			7.4			7			6.5				75
80	7	6.2		7.9		7.7			7.4			7			6.5				80
85	6.8	6		7.8		7.6			7.3			6.9			6.4				85
90	6.5	5.8		7.6	6.3		7.5	6.2		7.2		6.9			6.4				90
95	6.3	5.6		7.4	6.1		7.3	6.1		7.2	6	6.8			6.3				95
100	6.1	5.4		7.2	6		7.1	5.9		7	5.8	6.7	5.7		6.3				100
105	5.8	5.2		7	5.8		7	5.8		6.8	5.7	6.6	5.6		6.2	5.4			105
110	5.6	5	4.3	6.8	5.6		6.8	5.6		6.7	5.6	6.5	5.4		6.1	5.3			110
115	5.3	4.9	4.1	6.6	5.5		6.6	5.5		6.5	5.4	6.3	5.3		6.1	5.2			115
120	5.1	4.7	4.1	6.4	5.3	4.3	6.4	5.3		6.4	5.3	6.2	5.2		5.9	5.1			120
125	4.8	4.6	4	6.2	5.2	4.2	6.2	5.2	4.2	6.2	5.2	6	5.1		5.8	5			125
130	4.6	4.5	3.9	6	5.1	4.1	6.1	5.1	4.1	6	5.1	4.1	5.9	5	4	5.6	4.9		130
135	4.4	4.3	3.9	5.8	4.9	4.1	5.9	5	4	5.9	4.9	4	5.7	4.9	4	5.5	4.8		135
140	4.1	4.2	3.8	5.6	4.8	4	5.7	4.8	4	5.7	4.8	4	5.6	4.8	3.9	5.3	4.7	3.8	140
145	3.9	4.1	3.7	5.4	4.7	4	5.5	4.7	3.9	5.5	4.7	3.9	5.4	4.7	3.9	5.2	4.6	3.8	145
150	3.7	3.9	3.7	5.2	4.6	3.9	5.3	4.6	3.9	5.3	4.6	3.9	5.3	4.6	3.8	5.1	4.5	3.8	150
155	3.6	3.7	3.7	5	4.5	3.9	5.1	4.5	3.8	5.1	4.5	3.8	5.1	4.5	3.8	4.9	4.4	3.7	155
160	3.4	3.6	3.6	4.8	4.4	3.8	5	4.4	3.8	5	4.4	3.8	4.9	4.4	3.7	4.8	4.3	3.7	160
165	3.2	3.4	3.6	4.7	4.3	3.8	4.8	4.4	3.8	4.8	4.4	3.7	4.8	4.3	3.7	4.6	4.3	3.6	165
170	3.1	3.2	3.4	4.5	4.2	3.7	4.6	4.3	3.7	4.7	4.3	3.7	4.6	4.2	3.7	4.5	4.2	3.6	170
175	2.9	3.1	3.3	4.3	4.1	3.7	4.4	4.2	3.7	4.5	4.2	3.7	4.5	4.2	3.6	4.4	4.1	3.6	175
180	2.8	2.9	3.2	4.1	4	3.7	4.3	4.1	3.7	4.3	4.1	3.6	4.4	4.1	3.6	4.2	4	3.6	180
185	2.6	2.8	3.1	4	3.9	3.7	4.1	4	3.7	4.2	4	3.6	4.2	4	3.6	4.1	3.9	3.5	185
190	2.5	2.7		3.8	3.8	3.6	4	3.9	3.6	4	3.9	3.6	4.1	3.9	3.6	4	3.8	3.5	190
195	2.4	2.6		3.7	3.6	3.6	3.8	3.7	3.6	3.9	3.8	3.6	3.9	3.8	3.5	3.9	3.7	3.5	195
200	2.4			3.5	3.5	3.6	3.7	3.6	3.6	3.8	3.7	3.6	3.8	3.7	3.5	3.8	3.6	3.5	200
205				3.4	3.4	3.5	3.6	3.5	3.5	3.6	3.6	3.5	3.7	3.6	3.5	3.6	3.5	3.5	205
210				3.3	3.3	3.4	3.4	3.4	3.4	3.5	3.5	3.5	3.6	3.5	3.4	3.5	3.4	3.4	210
215				3.1	3.1	3.3	3.3	3.3	3.4	3.4	3.4	3.4	3.4	3.4	3.4	3.4	3.3	3.3	215
220				3	3	3.2	3.2	3.2	3.3	3.3	3.3	3.3	3.3	3.2	3.3	3.3	3.2	3.3	220
225				2.9	2.9	3.2	3	3.1	3.2	3.2	3.2	3.2	3.2	3.2	3.2	3.2	3.1	3.2	225
230				2.8	2.8		2.9	3	3.1	3	3.1	3.2	3.1	3.1	3.2	3.1	3.1	3.1	230
235				2.7	2.8		2.8	2.9	3.1	2.9	3	3.1	3	3	3.1	3	3	3.1	235
240				2.6	2.7		2.7	2.8		2.9	2.9	3.1	2.9	2.9	3.1	2.9	2.9	3	240
245				2.5	2.6		2.6	2.7		2.8	2.8	3	2.8	2.8	3	2.8	2.8	3	245
250				2.4			2.6	2.6		2.7	2.7	3	2.8	2.8	2.9	2.8	2.7	2.9	250
255				2.4			2.5	2.6		2.6	2.6		2.7	2.7	2.9	2.7	2.7	2.9	255
260							2.4	2.5		2.5	2.6		2.6	2.6	2.9	2.6	2.6	2.8	260
265							2.3			2.4	2.5		2.5	2.5		2.5	2.6	2.8	265
270							2.3			2.4	2.5		2.4	2.5		2.4	2.5	2.8	270
275										2.3			2.4	2.5		2.4	2.4	2.8	275
280													2.3	2.4		2.3	2.4		280
285													2.2	2.4		2.3	2.4		285
290													2.2				2.3		290
295																	2.3		295

t\_259\_107\_26151 / 46151\_00\_000

# Lifting capacities Forces de levage

TVNZK

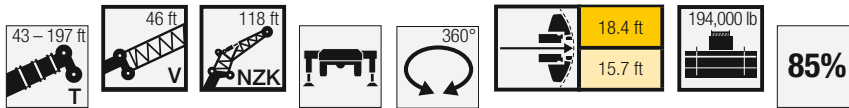

Lifting height (ft)	170 ft + 46 ft			180 ft + 46 ft			184 ft + 46 ft			194 ft + 46 ft			197 ft + 46 ft			Lifting height (ft)
	0°	22,5°	45°	0°	22,5°	45°	0°	22,5°	45°	0°	22,5°	45°	0°	22,5°	45°	
60	6.1															60
65	6			5.2			5.2									65
70	5.9			5.1			5.2			4.7			3.6			70
75	5.9			5.1			5.2			4.7			3.6			75
80	5.9			5.1			5.1			4.7			3.6			80
85	5.8			5			5.1			4.6			3.6			85
90	5.8			5			5.1			4.6			3.6			90
95	5.7			5			5			4.6			3.6			95
100	5.7			4.9			5			4.5			3.6			100
105	5.7			4.9			5			4.5			3.6			105
110	5.6	5		4.8			5			4.4			3.6			110
115	5.5	4.9		4.8			4.9			4.4			3.6			115
120	5.5	4.8		4.7	4.3		4.8	4.5		4.3			3.6			120
125	5.4	4.7		4.7	4.3		4.8	4.4		4.3	3.9		3.6	3.9		125
130	5.3	4.6		4.6	4.3		4.7	4.4		4.3	3.9		3.6	3.8		130
135	5.1	4.6		4.5	4.3		4.6	4.3		4.2	3.9		3.6	3.8		135
140	5	4.5		4.4	4.2		4.5	4.2		4.2	3.9		3.6	3.8		140
145	4.9	4.4	3.7	4.3	4.1		4.4	4.2		4.1	3.9		3.6	3.8		145
150	4.7	4.3	3.7	4.2	4.1	3.5	4.3	4.1	3.5	4	3.9		3.6	3.8		150
155	4.6	4.3	3.6	4.1	4	3.5	4.2	4	3.5	3.9	3.8	3.2	3.6	3.8	3.1	155
160	4.5	4.2	3.6	4	3.9	3.5	4.1	4	3.5	3.9	3.8	3.2	3.6	3.7	3.1	160
165	4.4	4.1	3.6	3.9	3.8	3.4	4	3.9	3.4	3.8	3.7	3.2	3.6	3.6	3.1	165
170	4.3	4	3.5	3.8	3.8	3.4	3.9	3.8	3.4	3.7	3.6	3.2	3.6	3.6	3.1	170
175	4.2	3.9	3.5	3.7	3.7	3.4	3.8	3.7	3.4	3.6	3.5	3.2	3.6	3.5	3.1	175
180	4	3.9	3.5	3.7	3.6	3.4	3.7	3.6	3.4	3.5	3.4	3.2	3.5	3.4	3.1	180
185	3.9	3.8	3.5	3.6	3.5	3.4	3.6	3.5	3.3	3.4	3.4	3.2	3.4	3.3	3.1	185
190	3.8	3.7	3.4	3.5	3.4	3.3	3.6	3.4	3.3	3.4	3.3	3.2	3.3	3.3	3.1	190
195	3.7	3.6	3.4	3.4	3.3	3.3	3.5	3.4	3.3	3.3	3.2	3.2	3.2	3.2	3.1	195
200	3.6	3.5	3.4	3.3	3.2	3.2	3.4	3.3	3.2	3.2	3.1	3.1	3.2	3.1	3.1	200
205	3.5	3.4	3.4	3.2	3.1	3.1	3.3	3.2	3.2	3.1	3.1	3.1	3.1	3	3	205
210	3.4	3.3	3.3	3.1	3.1	3	3.2	3.1	3.1	3	3	3	3	2.9	3	210
215	3.3	3.2	3.2	3	3	2.9	3.1	3.1	3.1	3	2.9	2.9	2.9	2.9	2.9	215
220	3.2	3.1	3.2	3	2.9	2.9	3	3	3	2.9	2.8	2.8	2.9	2.8	2.9	220
225	3.1	3.1	3.1	2.9	2.8	2.8	3	2.9	2.9	2.8	2.7	2.8	2.8	2.7	2.8	225
230	3	3	3.1	2.8	2.7	2.7	2.9	2.8	2.8	2.7	2.6	2.7	2.7	2.6	2.7	230
235	2.9	2.9	3	2.7	2.6	2.6	2.8	2.7	2.8	2.6	2.6	2.6	2.6	2.6	2.6	235
240	2.9	2.8	2.9	2.6	2.5	2.6	2.7	2.7	2.7	2.6	2.5	2.6	2.6	2.5	2.6	240
245	2.8	2.8	2.9	2.5	2.4	2.5	2.6	2.6	2.6	2.5	2.4	2.5	2.5	2.4	2.5	245
250	2.7	2.7	2.9	2.4	2.4	2.4	2.6	2.5	2.6	2.4	2.3	2.5	2.4	2.3	2.5	250
255	2.6	2.6	2.8	2.3	2.3	2.4	2.5	2.4	2.5	2.3	2.3	2.4	2.3	2.3	2.4	255
260	2.6	2.6	2.8	2.3	2.2	2.3	2.4	2.3	2.5	2.3		2.4	2.3		2.4	260
265	2.5	2.5	2.7			2.3	2.3	2.3	2.4			2.3			2.3	265
270	2.4	2.4	2.7			2.3	2.3	2.2	2.4			2.3			2.3	270
275	2.4	2.4	2.7						2.3			2.2			2.2	275
280	2.3	2.4	2.7						2.3							280
285	2.2	2.3	2.7						2.3							285
290		2.3	2.7						2.2							290
295		2.2							2.2							295
300		2.2							2.2							300
305		2.2							2.2							305

t\_259\_107\_26151 / 46151\_00\_000

# Lifting heights Hauteurs de levage

TVNZK

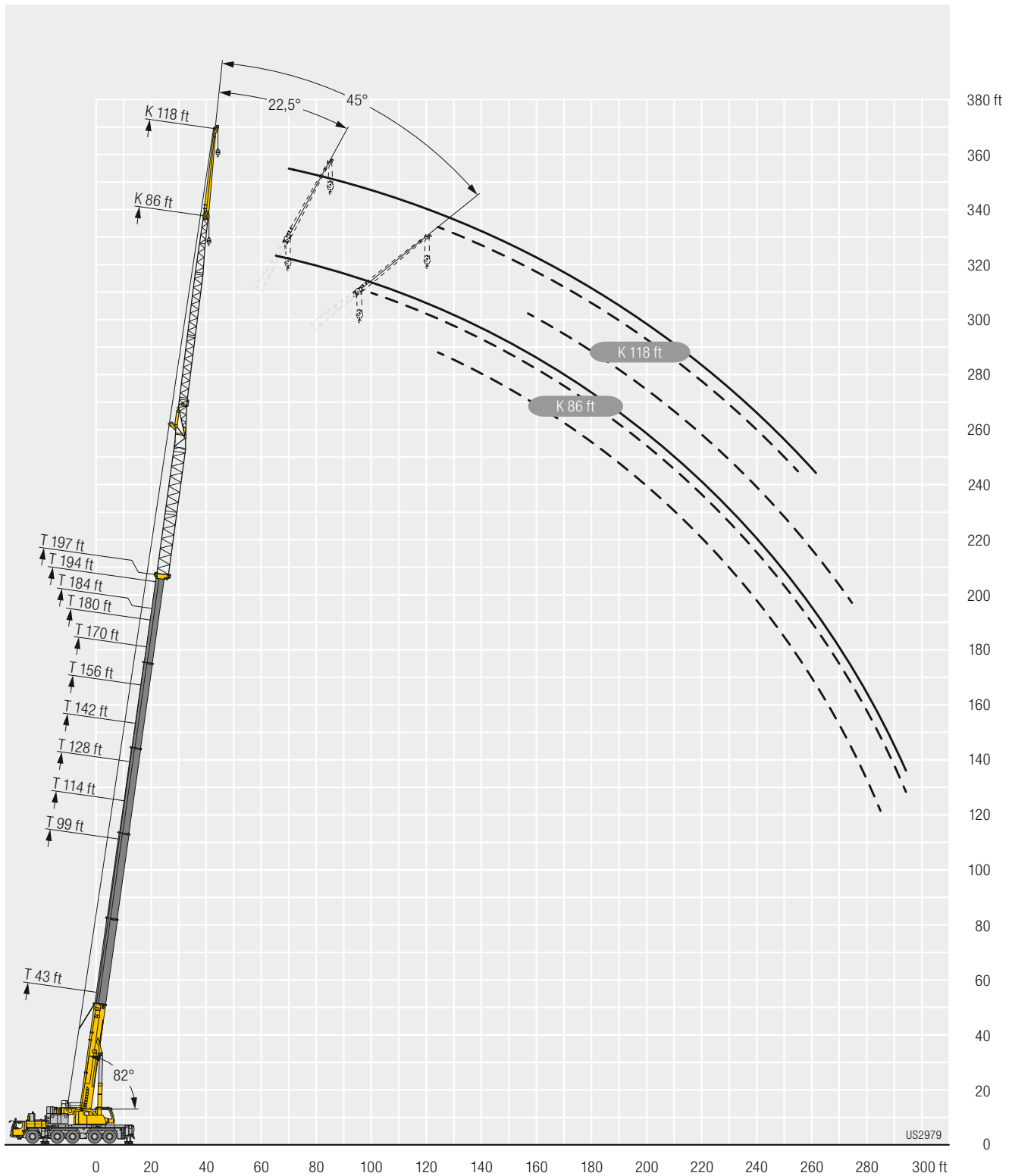



# Lifting capacities Forces de levage

TS



	43 ft	57 ft	71 ft	73 ft	85 ft	99 ft	114 ft	128 ft	142 ft	156 ft	170 ft	180 ft	184 ft	194 ft	197 ft	
	13 ft															
10	90.8	90.8														10
11	90.8	90.8														11
12	90.8	90.8														12
13	90.8	90.8	90.8	90.8												13
14	90.8	90.8	90.8	90.8												14
15	90.8	90.8	90.8	90.8	90.8											15
16	90.8	90.8	90.8	90.8	90.8											16
17	90.8	90.8	90.8	90.8	90.8											17
18	90.8	90.8	90.8	90.8	90.8											18
19	90.8	90.8	90.8	90.8	90.8	90.8										19
20	90.8	90.8	90.8	90.8	90.8	90.8										20
22	90.8	90.8	90.8	90.8	90.8	90.8	90.8									22
24	90.4	90.8	90.8	90.8	90.8	90.8	90.8									24
26	89.1	90.8	90.8	90.8	90.8	90.8	90.8	90.8								26
28	87.5	90.8	90.8	90.8	90.8	90.8	90.8	90.8	90.8							28
30	85	90.6	90.8	90.8	90.8	90.8	90.8	90.8	90.8	90.8						30
32	82.2	89.5	90.8	90.8	90.8	90.8	90.8	90.8	90.8	72.8						32
34	78.9	88.5	90.8	90.8	90.8	90.8	90.8	90.8	90.8	81.4						34
36	75.6	87	90.7	90.7	90.8	90.8	90.8	90.8	90.8	80.4	61.5					36
38	72.7	84.9	89.8	90.3	90.8	90.8	90.8	90.8	90.8	79.3	65.1					38
40	70	82.8	89	89.5	90.8	90.8	90.8	90.8	90.5	78.1	64.3	51.6	53.7			40
45	64.3	76.2	85.8	86.9	89.7	90.8	90.8	90.7	85.6	74.4	62.1	50.2	52.3	44.8	44	45
50	60.3	70.6	81.2	82.7	87.6	90.2	90.5	86.3	79.4	70.5	59.5	48.3	50.5	43.9	43.1	50
55		66	75.7	77.4	84.2	88.6	89.6	79.2	73.5	66.6	56.9	46.2	48.5	42.7	42	55
60		62.2	71.1	72.7	79.9	85.6	85.5	73.2	68	62.9	54.3	44	46.6	41.3	40.7	60
65			67.2	68.6	75.3	78.8	77.4	68.5	63.1	59.5	51.9	41.8	44.7	39.9	39.4	65
70			63.8	65.1	71.4	71.6	70.1	64.4	58.8	55.9	49.5	39.8	42.9	38.4	38	70
75			61.1	61.8	66.3	65.3	63.9	60.5	55.1	52.5	47.1	37.9	41.1	36.7	36.5	75
80				49.9	60.8	59.9	58.4	57.2	52.3	49.3	44.9	36	39.5	35.2	35	80
85					56.1	55.2	53.7	53.1	49.4	46.4	42.8	34.3	37.9	33.8	33.7	85
90					48.8	51	49.6	49	46.5	43.7	40.8	32.7	36.5	32.4	32.3	90
95						47.4	45.9	45.6	44.1	41.2	38.8	31.3	35.1	31.1	31	95
100						44.2	42.6	43.5	42.1	39	37.3	30	33.8	29.9	29.8	100
105						36.2	40.2	40.6	39.8	36.9	35.6	28.6	32.6	28.8	28.7	105
110							38	37.8	37.2	34.9	33.8	27.4	31.4	27.7	27.7	110
115							36.7	35.4	34.7	33.2	32.1	26.3	30.1	26.6	26.6	115
120							28.2	33.1	32.4	31.9	30.6	25.2	28.9	25.6	25.6	120
125								31.1	30.4	30.5	29.1	24.2	27.6	24.7	24.6	125
130								29	28.7	28.8	27.7	23.3	26.4	23.8	23.7	130
135								21.1	27.7	27.1	26	22.4	25.2	23	22.7	135
140									26.2	25.5	24.8	21.5	24.1	22.2	21.9	140
145									23.5	24	23.5	20.7	22.9	21.4	21	145
150										22.7	22.6	19.9	21.5	20.7	20.2	150
155										21.9	21.4	19.1	20.2	20	19.4	155
160										18.8	20.2	18.5	19	19.2	18.7	160
165											19.1	17.8	17.9	18.2	17.9	165
170											17.9	17.2	16.9	17.1	16.9	170
175											13.8	16.7	15.9	16.1	15.9	175
180												16	15	15.2	15	180
185												11.9	13.5	14.3	14.1	185
190													9.2	13.5	13.2	190
195														11.9	11.5	195
200														7.8	9.5	200

t\_259\_105\_10151 / 30151\_00\_000

# Lifting capacities

## Forces de levage

TS



	43 ft	99 ft	114 ft	128 ft	142 ft	156 ft	170 ft	180 ft	184 ft	194 ft	197 ft	
	36 ft											
12	77.5											12
13	75.8											13
14	72.9											14
15	70.2											15
16	67.5											16
17	65.1											17
18	62.7											18
19	60.4											19
20	58.2											20
22	54.3	77.1										22
24	50.7	73.7										24
26	47.7	70.5	68.5									26
28	44.8	67.5	67.7	65.9								28
30	42.2	64.6	65.7	63.9								30
32	39.9	61.8	63.5	61.9	58.2							32
34	37.8	59.3	61.3	60.1	57.2							34
36	36	56.9	59.2	58.3	55.8	51.8						36
38	34.1	54.6	57.2	56.6	54.4	50.7						38
40	32.5	52.5	55.2	55	53.1	49.7	44.8					40
45	29.1	47.9	50.6	51.1	49.9	47.2	43.3	37.7	38.2			45
50	26.3	43.7	46.6	47.4	46.9	44.8	41.6	36.5	37.1	34.1	33.5	50
55	23.9	40.3	43	44.2	44	42.4	39.9	35.4	36	33.4	32.8	55
60	21.9	37.3	40.1	41.4	41.4	40.3	38.2	34.2	34.9	32.5	32.1	60
65	20.2	34.7	37.3	38.8	39.2	38.3	36.7	33.2	33.7	31.7	31.3	65
70	18.8	32.4	35.1	36.5	37	36.5	35.2	32.1	32.7	30.8	30.5	70
75		30.4	33	34.5	35.1	34.8	33.9	31.1	31.6	30	29.7	75
80		28.5	31.1	32.6	33.4	33.2	32.6	30	30.6	29.2	28.9	80
85		26.9	29.3	30.9	31.8	31.8	31.3	29	29.7	28.4	28.1	85
90		25.4	27.8	29.4	30.3	30.4	30.2	27.9	28.8	27.5	27.3	90
95		24.1	26.4	28	28.9	29.2	29.1	26.9	27.9	26.6	26.5	95
100		23	25.2	26.7	27.7	28.1	28.1	25.9	27.1	25.7	25.6	100
105		21.9	24	25.6	26.6	27	27.2	24.9	26.3	24.8	24.8	105
110		20.9	23	24.5	25.5	26	26.3	24	25.5	24	23.9	110
115		20	22	23.5	24.6	25.1	25.4	23.1	24.8	23.1	23.1	115
120		19.2	21.1	22.5	23.7	24.2	24.7	22.2	24.2	22.4	22.3	120
125		18.5	20.3	21.7	22.8	23.4	23.9	21.4	23.5	21.6	21.6	125
130		18.1	19.6	20.9	22	22.7	23.2	20.6	22.9	20.8	20.8	130
135			18.9	20.3	21.3	22	22.6	19.8	22.2	20.1	20.1	135
140			18.4	19.6	20.7	21.4	22	19.1	21.6	19.4	19.4	140
145				19	20	20.8	21.4	18.4	20.9	18.8	18.8	145
150				18.5	19.5	20.2	20.9	17.8	20.3	18.2	18.2	150
155				17.7	19	19.7	20.3	17.2	19.7	17.6	17.6	155
160					18.5	19.1	19.2	16.6	19.1	17	17.1	160
165					18.1	18.7	18.2	16	18.4	16.5	16.5	165
170					16.1	18	17.6	15.5	17.5	16	16	170
175						17	17.1	15	16.5	15.6	15.5	175
180						15.6	16.6	14.5	15.5	15.1	14.9	180
185						12.2	15.8	14.1	14.7	14.6	14.4	185
190							15	13.6	13.8	13.8	13.7	190
195							12.9	13.2	13.1	13.1	12.9	195
200							7.9	12.8	12.3	12.3	12.1	200
205								11.2	11.5	11.6	11.4	205
210								6.6	9	11	10.8	210
215									4	10.2	10.2	215
220										7.7	8.5	220
225										2.8	5.6	225

t\_259\_105\_11151 / 31151\_00\_000

# Lifting capacities

## Forces de levage

TS

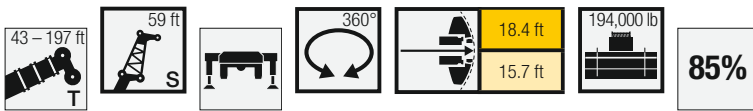

	43 ft	99 ft	114 ft	128 ft	142 ft	156 ft	170 ft	180 ft	184 ft	194 ft	197 ft	
	59 ft											
16	56.2											16
17	55.8											17
18	54.7											18
19	53.6											19
20	52.5											20
22	50.4											22
24	48.3											24
26	46.3											26
28	44.4	54.9										28
30	42.7	53.5	52.8									30
32	41	52.1	51.6									32
34	39.4	50.8	50.5	48.4								34
36	37.9	49.4	49.3	47.6								36
38	36.4	48.2	48.2	46.7	43.9							38
40	35.1	46.9	47.1	45.8	43.2							40
45	32.1	43.8	44.3	43.4	41.4	38.2						45
50	29.6	41.1	41.8	41.2	39.7	36.9	33.2	28.4	29			50
55	27.4	38.6	39.5	39.2	38	35.7	32.4	27.8	28.6	25.8	25.3	55
60	25.5	36.3	37.4	37.4	36.5	34.5	31.6	27.1	28.1	25.3	24.9	60
65	23.8	34.2	35.3	35.6	35	33.3	30.8	26.4	27.5	24.8	24.5	65
70	22.4	32.3	33.5	33.9	33.7	32.3	30	25.6	27	24.3	24	70
75	21.1	30.7	31.8	32.3	32.3	31.2	29.1	24.9	26.4	23.8	23.5	75
80	19.9	29.1	30.4	30.9	31	30.1	28.3	24.2	25.8	23.2	22.9	80
85	18.8	27.7	29	29.6	29.8	29.1	27.5	23.6	25	22.7	22.4	85
90	17.8	26.5	27.7	28.4	28.7	28.1	26.8	22.9	24.1	22.1	21.9	90
95	17	25.3	26.6	27.3	27.6	27.2	26.1	22.2	23.4	21.6	21.4	95
100		24.2	25.5	26.2	26.7	26.3	25.4	21.4	22.6	21	20.9	100
105		23.2	24.5	25.3	25.8	25.6	24.7	20.7	21.9	20.4	20.3	105
110		22.4	23.6	24.4	24.9	24.8	24.1	20	21.2	19.9	19.8	110
115		21.5	22.7	23.5	24.2	24.1	23.4	19.4	20.6	19.3	19.2	115
120		20.8	21.9	22.7	23.4	23.4	22.9	18.8	19.9	18.8	18.7	120
125		20.1	21.2	22	22.7	22.8	22.4	18.2	19.4	18.2	18.2	125
130		19.4	20.5	21.3	22.1	22.2	21.8	17.7	18.8	17.7	17.7	130
135		18.7	19.9	20.7	21.5	21.6	21.2	17.1	18.3	17.2	17.2	135
140		18	19.3	20.1	20.9	21.1	20.6	16.6	17.8	16.7	16.7	140
145		17.4	18.7	19.6	20.4	20.6	20	16.1	17.3	16.2	16.2	145
150		17	18.2	19.1	19.9	20.1	19.4	15.5	16.9	15.7	15.7	150
155			17.6	18.6	19.4	19.7	18.8	15	16.4	15.2	15.2	155
160			17.2	18.1	19	19.1	18.3	14.5	16	14.8	14.8	160
165			16.1	17.6	18.5	18.2	17.7	14	15.6	14.3	14.3	165
170				17.2	18.1	17.2	17.1	13.5	15.2	13.9	13.9	170
175				15.9	17.3	16.3	16.3	13.1	14.9	13.4	13.5	175
180				12.1	16.4	15.8	15.4	12.7	14.5	13	13	180
185					15.5	15.3	14.5	12.2	14.1	12.6	12.7	185
190					13.1	14.8	13.6	11.9	13.7	12.2	12.3	190
195					9.9	14	13	11.5	13.2	11.9	11.9	195
200						13.1	12.7	11.1	12.4	11.5	11.6	200
205						11.7	12.4	10.8	11.7	11.2	11.2	205
210							12.1	10.5	11.1	10.9	10.8	210
215							11.1	10.2	10.4	10.4	10.2	215
220							8.2	10	9.8	9.8	9.6	220
225								9.5	9.3	9.2	9	225
230								7	7.8	8.7	8.5	230
235									5.3	8.1	8	235
240										6.7	7.2	240
245										4.4	5.3	245

t\_259\_105\_13151 / 33151\_00\_000

# Lifting capacities

## Forces de levage

TS

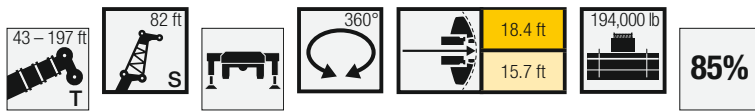

	43 ft	99 ft	114 ft	128 ft	142 ft	156 ft	170 ft	180 ft	184 ft	194 ft	197 ft	
	82 ft											
20	40											20
22	39.2											22
24	37.9											24
26	36.6											26
28	35.3											28
30	34.1											30
32	32.9	39.3										32
34	31.7	38.4	37.8									34
36	30.6	37.6	37.1									36
38	29.6	36.7	36.3	34.8								38
40	28.6	35.8	35.5	34.3								40
45	26.5	33.6	33.6	32.6	30.9							45
50	24.5	31.6	31.8	31.1	29.7	27.5	24.6					50
55	22.8	29.8	30.1	29.6	28.5	26.6	24.1	20.5	20.8			55
60	21.3	28.2	28.6	28.2	27.3	25.7	23.5	20.1	20.5	18.7	18.4	60
65	19.9	26.7	27.1	27	26.2	24.8	22.8	19.8	20.1	18.5	18.2	65
70	18.8	25.3	25.9	25.8	25.2	24	22.2	19.4	19.7	18.2	17.9	70
75	17.7	24.1	24.7	24.7	24.2	23.2	21.6	19	19.3	17.9	17.7	75
80	16.7	22.9	23.5	23.7	23.3	22.4	21	18.6	18.9	17.6	17.4	80
85	15.9	21.9	22.5	22.7	22.4	21.7	20.4	18.2	18.5	17.3	17.1	85
90	15.1	20.9	21.6	21.8	21.6	21	19.8	17.8	18.1	17	16.8	90
95	14.3	19.9	20.7	21	20.9	20.3	19.3	17.4	17.8	16.6	16.5	95
100	13.6	19.1	19.8	20.2	20.1	19.7	18.8	16.9	17.4	16.3	16.1	100
105	12.9	18.4	19.1	19.5	19.4	19.1	18.3	16.5	17	15.9	15.8	105
110	12.4	17.6	18.4	18.8	18.8	18.5	17.8	16	16.6	15.5	15.4	110
115	11.9	17	17.7	18.1	18.2	18	17.3	15.6	16.1	15.2	15.1	115
120		16.3	17.1	17.5	17.7	17.5	16.9	15.1	15.7	14.8	14.7	120
125		15.8	16.5	16.9	17.1	17	16.4	14.7	15.3	14.5	14.4	125
130		15.3	16	16.4	16.6	16.5	16.1	14.3	14.9	14.2	14.1	130
135		14.7	15.5	15.9	16.1	16.1	15.7	13.9	14.5	13.8	13.8	135
140		14.2	15	15.4	15.7	15.7	15.3	13.5	14.1	13.5	13.4	140
145		13.7	14.5	15	15.3	15.3	15	13.2	13.7	13.2	13.1	145
150		13.3	14	14.5	14.9	14.9	14.6	12.8	13.4	12.8	12.8	150
155		12.9	13.6	14.1	14.5	14.5	14.3	12.4	13	12.5	12.5	155
160		12.5	13.2	13.7	14.1	14.2	14	12.1	12.7	12.2	12.2	160
165		12.1	12.8	13.3	13.7	13.8	13.7	11.8	12.4	11.8	11.8	165
170		11.9	12.5	13	13.3	13.5	13.4	11.5	12.2	11.5	11.6	170
175		11.7	12.2	12.7	13	13.2	13.1	11.2	11.9	11.3	11.3	175
180			11.9	12.4	12.7	12.9	12.9	10.9	11.6	11	11	180
185			11.7	12.1	12.4	12.6	12.6	10.6	11.4	10.7	10.8	185
190			8.8	11.8	12.2	12.4	12.4	10.3	11.1	10.5	10.5	190
195				11.6	11.9	12.1	12.1	10.1	10.9	10.2	10.2	195
200				10.8	11.7	11.9	11.9	9.8	10.6	10	10	200
205					11.5	11.6	11.6	9.5	10.4	9.7	9.7	205
210					11.2	11.4	11	9.2	10.2	9.4	9.5	210
215					9.2	11.3	10.3	8.9	10	9.2	9.2	215
220						10.9	9.7	8.6	9.8	8.9	8.9	220
225						9.3	9.4	8.4	9.5	8.6	8.7	225
230						7.4	9.3	8.1	9	8.4	8.4	230
235							9.1	7.9	8.5	8.2	8.1	235
240							7.6	7.6	8	7.9	7.8	240
245							4.9	7.5	7.5	7.4	7.3	245
250								6.6	6.8	7.1	6.9	250
255								3.9	5.1	6.7	6.6	255
260										5.9	6	260
265										4.2	4.8	265
270											2.7	270

t\_259\_105\_15151 / 35151\_00\_000

# Lifting capacities

## Forces de levage

TS



	43 ft	99 ft	114 ft	128 ft	142 ft	156 ft	170 ft	180 ft	184 ft	194 ft	197 ft	
	105 ft											
24	28.7											24
26	28.4											26
28	27.8											28
30	26.9											30
32	26.1											32
34	25.4											34
36	24.6	28.4										36
38	23.9	28	27.3									38
40	23.2	27.5	26.9									40
45	21.5	26	25.7	24.7	22.9							45
50	20	24.6	24.5	23.7	22.3	20.5						50
55	18.7	23.3	23.3	22.7	21.6	20	17.9					55
60	17.5	22.1	22.2	21.7	20.8	19.4	17.5	15.1	15.4			60
65	16.4	21	21.1	20.8	20.1	18.8	17.1	14.9	15.1	13.9	13.6	65
70	15.4	19.9	20.1	19.9	19.3	18.2	16.7	14.6	14.8	13.7	13.4	70
75	14.5	19	19.2	19.1	18.6	17.7	16.3	14.3	14.6	13.4	13.2	75
80	13.6	18	18.4	18.3	18	17.1	15.9	14	14.3	13.2	13	80
85	12.9	17.2	17.6	17.5	17.3	16.6	15.4	13.7	14	13	12.8	85
90	12.2	16.4	16.8	16.8	16.7	16.1	15	13.4	13.7	12.7	12.6	90
95	11.5	15.7	16.1	16.2	16.2	15.6	14.6	13.1	13.4	12.5	12.4	95
100	10.9	15	15.4	15.5	15.6	15.1	14.3	12.9	13.1	12.3	12.1	100
105	10.4	14.4	14.8	15	15.1	14.6	13.9	12.6	12.8	12	11.9	105
110	9.8	13.8	14.2	14.4	14.6	14.2	13.5	12.3	12.5	11.8	11.7	110
115	9.3	13.2	13.7	13.9	14.1	13.8	13.2	12	12.2	11.6	11.5	115
120	8.9	12.7	13.2	13.4	13.6	13.4	12.8	11.7	12	11.4	11.3	120
125	8.5	12.2	12.7	12.9	13.2	13	12.5	11.4	11.7	11.1	11	125
130	8.1	11.7	12.2	12.5	12.8	12.6	12.2	11.1	11.4	10.9	10.8	130
135	7.8	11.3	11.8	12.1	12.4	12.3	11.9	10.8	11.2	10.7	10.6	135
140	7.6	10.8	11.4	11.7	12.1	11.9	11.6	10.5	10.9	10.4	10.4	140
145		10.4	10.9	11.3	11.7	11.6	11.3	10.2	10.6	10.2	10.2	145
150		10	10.6	10.9	11.3	11.3	11	9.9	10.3	9.9	9.9	150
155		9.7	10.2	10.5	11	11	10.8	9.6	10.1	9.7	9.7	155
160		9.3	9.8	10.2	10.7	10.7	10.5	9.4	9.8	9.4	9.4	160
165		9	9.5	9.9	10.4	10.5	10.3	9.1	9.5	9.2	9.2	165
170		8.7	9.2	9.5	10.2	10.2	10.1	8.8	9.2	8.9	8.9	170
175		8.4	8.9	9.2	9.9	10	9.8	8.6	9	8.7	8.7	175
180		8.2	8.6	9	9.6	9.7	9.6	8.4	8.8	8.5	8.5	180
185		8	8.4	8.7	9.4	9.5	9.4	8.2	8.6	8.3	8.3	185
190		7.8	8.1	8.5	9.1	9.3	9.2	8	8.3	8.1	8.1	190
195		7.6	7.9	8.3	8.9	9	9	7.8	8.1	7.9	7.9	195
200			7.8	8.1	8.7	8.8	8.8	7.6	8	7.7	7.7	200
205			7.6	7.9	8.5	8.6	8.6	7.5	7.8	7.6	7.6	205
210			7.5	7.7	8.3	8.4	8.4	7.3	7.6	7.4	7.4	210
215				7.5	8.1	8.3	8.3	7.2	7.5	7.3	7.3	215
220				7.4	7.9	8.1	8.1	7.1	7.4	7.2	7.2	220
225				6.6	7.8	8	8	7	7.2	7.1	7.1	225
230					7.7	7.8	7.8	6.8	7.1	7	7	230
235					7.6	7.7	7.7	6.7	7	6.8	6.9	235
240					6.5	7.6	7.6	6.6	6.9	6.7	6.8	240
245						7.5	7.4	6.5	6.8	6.6	6.6	245
250						6.5	7	6.3	6.7	6.5	6.5	250
255						3.9	6.7	6.2	6.6	6.4	6.4	255
260							6.5	6	6.4	6.2	6.2	260
265							4.9	5.9	6.1	6	5.8	265
270								5.7	5.6	5.7	5.5	270
275								4	4.4	5.3	5.2	275
280									2.5	4.8	4.9	280
285										3.5	3.9	285
290											2.3	290

t\_259\_105\_18151 / 38151\_00\_000

# Lifting capacities

## Forces de levage

TS



	43 ft	99 ft	114 ft	128 ft	142 ft	156 ft	170 ft	180 ft	184 ft	194 ft	197 ft	
	128 ft											
28	21.9											28
30	21.7											30
32	21.2											32
34	20.7											34
36	20.2											36
38	19.7											38
40	19.2	21.7										40
45	18	20.8	20.3									45
50	16.8	19.8	19.5	18.7	17.5							50
55	15.8	18.9	18.7	18	17	15.7						55
60	14.8	18	17.9	17.3	16.5	15.2	13.6					60
65	13.9	17.2	17.1	16.7	15.9	14.8	13.3	11.4	11.6			65
70	13.1	16.3	16.3	16	15.4	14.3	13	11.2	11.4	10.4	10.2	70
75	12.3	15.6	15.6	15.4	14.8	13.9	12.7	10.9	11.1	10.2	10	75
80	11.6	14.8	15	14.7	14.3	13.5	12.3	10.7	10.9	10	9.9	80
85	10.9	14.2	14.3	14.2	13.8	13	12	10.5	10.7	9.8	9.7	85
90	10.3	13.5	13.7	13.6	13.2	12.6	11.7	10.3	10.4	9.6	9.5	90
95	9.7	12.9	13.1	13.1	12.8	12.2	11.4	10	10.2	9.4	9.3	95
100	9.2	12.3	12.6	12.6	12.3	11.8	11	9.8	10	9.2	9.1	100
105	8.7	11.8	12	12.1	11.9	11.5	10.7	9.5	9.7	9.1	8.9	105
110	8.2	11.3	11.6	11.6	11.5	11.1	10.4	9.3	9.5	8.9	8.8	110
115	7.8	10.8	11.1	11.2	11.1	10.7	10.1	9.1	9.3	8.7	8.6	115
120	7.5	10.3	10.7	10.7	10.7	10.4	9.8	8.9	9	8.5	8.4	120
125	7.1	9.9	10.2	10.4	10.3	10.1	9.5	8.6	8.8	8.3	8.2	125
130	6.8	9.5	9.8	10	9.9	9.7	9.2	8.4	8.6	8.1	8	130
135	6.5	9.1	9.4	9.6	9.6	9.4	9	8.2	8.4	8	7.9	135
140	6.2	8.7	9.1	9.3	9.3	9.1	8.8	8	8.2	7.8	7.7	140
145	6	8.4	8.7	8.9	9	8.9	8.5	7.8	8	7.6	7.5	145
150	5.7	8.1	8.4	8.6	8.7	8.6	8.3	7.6	7.8	7.5	7.4	150
155	5.5	7.8	8.1	8.3	8.4	8.3	8.1	7.4	7.6	7.3	7.2	155
160	5.3	7.5	7.8	8	8.1	8.1	7.9	7.2	7.4	7.2	7.1	160
165	5.2	7.2	7.6	7.8	7.9	7.8	7.6	7.1	7.3	7	7	165
170		7	7.3	7.5	7.6	7.6	7.5	6.9	7.1	6.9	6.8	170
175		6.7	7.1	7.3	7.4	7.4	7.3	6.7	6.9	6.7	6.7	175
180		6.5	6.8	7.1	7.2	7.2	7.1	6.5	6.8	6.6	6.5	180
185		6.3	6.6	6.9	7	7	6.9	6.4	6.6	6.4	6.4	185
190		6.1	6.4	6.7	6.8	6.8	6.7	6.2	6.5	6.2	6.2	190
195		5.9	6.3	6.5	6.6	6.7	6.6	6.1	6.3	6.1	6.1	195
200		5.8	6.1	6.3	6.5	6.5	6.5	5.9	6.2	6	6	200
205		5.6	5.9	6.1	6.3	6.4	6.3	5.8	6	5.8	5.8	205
210		5.5	5.7	6	6.1	6.2	6.2	5.6	5.9	5.7	5.7	210
215		5.3	5.6	5.8	6	6.1	6	5.5	5.7	5.6	5.6	215
220		5.3	5.5	5.7	5.8	5.9	5.9	5.4	5.6	5.5	5.5	220
225			5.3	5.5	5.7	5.8	5.8	5.3	5.5	5.3	5.4	225
230			5.3	5.4	5.6	5.7	5.7	5.2	5.4	5.2	5.3	230
235			5.2	5.3	5.5	5.6	5.6	5	5.3	5.1	5.1	235
240				5.2	5.3	5.5	5.5	4.9	5.2	5	5	240
245				5.2	5.3	5.3	5.4	4.8	5.1	4.9	4.9	245
250				4.5	5.2	5.3	5.3	4.8	5	4.9	4.9	250
255					5.1	5.2	5.2	4.7	4.9	4.8	4.8	255
260					4.9	5.1	5.1	4.6	4.8	4.7	4.7	260
265						5	5	4.5	4.7	4.6	4.6	265
270						5	5	4.5	4.6	4.5	4.6	270
275						4.3	4.9	4.4	4.6	4.5	4.5	275
280							4.5	4.4	4.5	4.4	4.4	280
285							4.2	4.3	4.5	4.4	4.3	285
290								4.2	4.4	4.2	4	290
295								3.3	3.3	3.9	3.7	295
300										3.5	3.4	300
305										2.4	2.6	305

t\_259\_105\_22151 / 42151\_00\_000

# Lifting capacities

## Forces de levage

TS

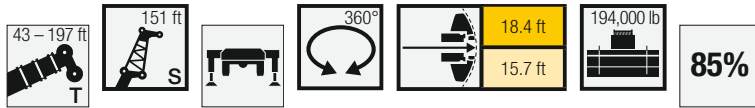

	43 ft	99 ft	114 ft	128 ft	142 ft	156 ft	170 ft	180 ft	184 ft	194 ft	197 ft	
	151 ft											
32	15.4											32
34	15.3											34
36	15.1											36
38	14.9											38
40	14.6											40
45	14	15.2										45
50	13.4	14.8	14.4	13.7								50
55	12.7	14.3	14	13.4	12.7							55
60	11.9	13.9	13.6	13.1	12.4	11.4						60
65	11.3	13.4	13.2	12.7	12	11.1	9.9					65
70	10.6	12.8	12.7	12.3	11.7	10.8	9.7	8.2	8.4			70
75	10	12.2	12.2	11.8	11.3	10.5	9.5	8	8.2	7.4	7.3	75
80	9.5	11.7	11.7	11.4	10.9	10.2	9.2	7.9	8	7.3	7.2	80
85	8.9	11.2	11.2	11	10.6	9.9	9	7.7	7.8	7.2	7.1	85
90	8.4	10.7	10.7	10.6	10.2	9.6	8.8	7.6	7.7	7.1	7	90
95	8	10.2	10.3	10.2	9.8	9.3	8.5	7.4	7.5	7	6.9	95
100	7.5	9.8	9.9	9.8	9.5	9	8.3	7.3	7.4	6.9	6.8	100
105	7.1	9.4	9.5	9.4	9.1	8.7	8	7.1	7.2	6.7	6.7	105
110	6.8	8.9	9.1	9	8.8	8.4	7.8	7	7.1	6.6	6.5	110
115	6.4	8.5	8.7	8.7	8.5	8.2	7.6	6.8	6.9	6.5	6.4	115
120	6.1	8.2	8.4	8.3	8.2	7.9	7.4	6.7	6.8	6.4	6.3	120
125	5.8	7.8	8	8	7.9	7.6	7.2	6.5	6.6	6.2	6.2	125
130	5.6	7.5	7.7	7.7	7.7	7.4	7	6.4	6.5	6.1	6	130
135	5.3	7.2	7.4	7.5	7.4	7.2	6.8	6.2	6.3	6	5.9	135
140	5.1	6.9	7.1	7.2	7.2	7	6.7	6.1	6.2	5.8	5.8	140
145	4.8	6.7	6.9	7	6.9	6.8	6.5	5.9	6	5.7	5.7	145
150	4.6	6.4	6.6	6.7	6.7	6.6	6.3	5.8	5.9	5.6	5.5	150
155	4.4	6.2	6.4	6.5	6.5	6.4	6.1	5.6	5.8	5.5	5.4	155
160	4.2	5.9	6.2	6.3	6.3	6.2	6	5.5	5.6	5.3	5.3	160
165	4	5.7	5.9	6.1	6.1	6	5.8	5.4	5.5	5.2	5.2	165
170	3.9	5.5	5.7	5.9	5.9	5.9	5.7	5.3	5.3	5.1	5.1	170
175	3.7	5.3	5.5	5.7	5.8	5.7	5.5	5.1	5.2	5	5	175
180	3.6	5.1	5.3	5.5	5.6	5.5	5.4	5	5.1	4.9	4.9	180
185	3.5	4.9	5.1	5.3	5.4	5.4	5.2	4.9	5	4.8	4.8	185
190		4.7	5	5.1	5.2	5.2	5.1	4.8	4.9	4.7	4.7	190
195		4.6	4.8	5	5.1	5.1	4.9	4.7	4.7	4.6	4.6	195
200		4.4	4.6	4.8	4.9	4.9	4.8	4.6	4.6	4.5	4.5	200
205		4.3	4.5	4.7	4.8	4.8	4.7	4.4	4.5	4.4	4.4	205
210		4.1	4.4	4.5	4.6	4.7	4.6	4.3	4.4	4.3	4.3	210
215		4	4.2	4.4	4.5	4.5	4.5	4.2	4.3	4.2	4.2	215
220		3.9	4.1	4.2	4.4	4.4	4.4	4.1	4.2	4.1	4.1	220
225		3.8	4	4.1	4.2	4.3	4.2	4	4.1	4	4	225
230		3.7	3.8	4	4.1	4.2	4.1	3.9	4	3.9	3.9	230
235		3.5	3.7	3.9	4	4.1	4	3.8	3.9	3.8	3.8	235
240		3.5	3.6	3.8	3.9	4	4	3.7	3.8	3.7	3.7	240
245		3.4	3.5	3.7	3.8	3.9	3.9	3.6	3.7	3.7	3.7	245
250			3.5	3.6	3.7	3.8	3.8	3.5	3.7	3.6	3.6	250
255			3.4	3.5	3.6	3.7	3.7	3.4	3.6	3.5	3.5	255
260				3.4	3.5	3.6	3.6	3.3	3.5	3.4	3.4	260
265				3.4	3.4	3.5	3.5	3.3	3.4	3.3	3.3	265
270				3.4	3.4	3.4	3.5	3.2	3.3	3.3	3.3	270
275					3.3	3.4	3.4	3.1	3.3	3.2	3.2	275
280					3.3	3.3	3.3	3	3.2	3.1	3.1	280
285					3	3.3	3.3	3	3.1	3.1	3.1	285
290						3.2	3.2	2.9	3.1	3	3	290
295						3	3.2	2.9	3	2.9	2.9	295
300							3	2.9	3	2.9	2.9	300
305							2.9	2.8	2.9	2.8	2.8	305
310								2.8	2.8	2.7	2.5	310
315								2.3		2.5	2.3	315

t\_259\_105\_24151 / 44151\_00\_000



# Lifting heights Hauteurs de levage

**TS**

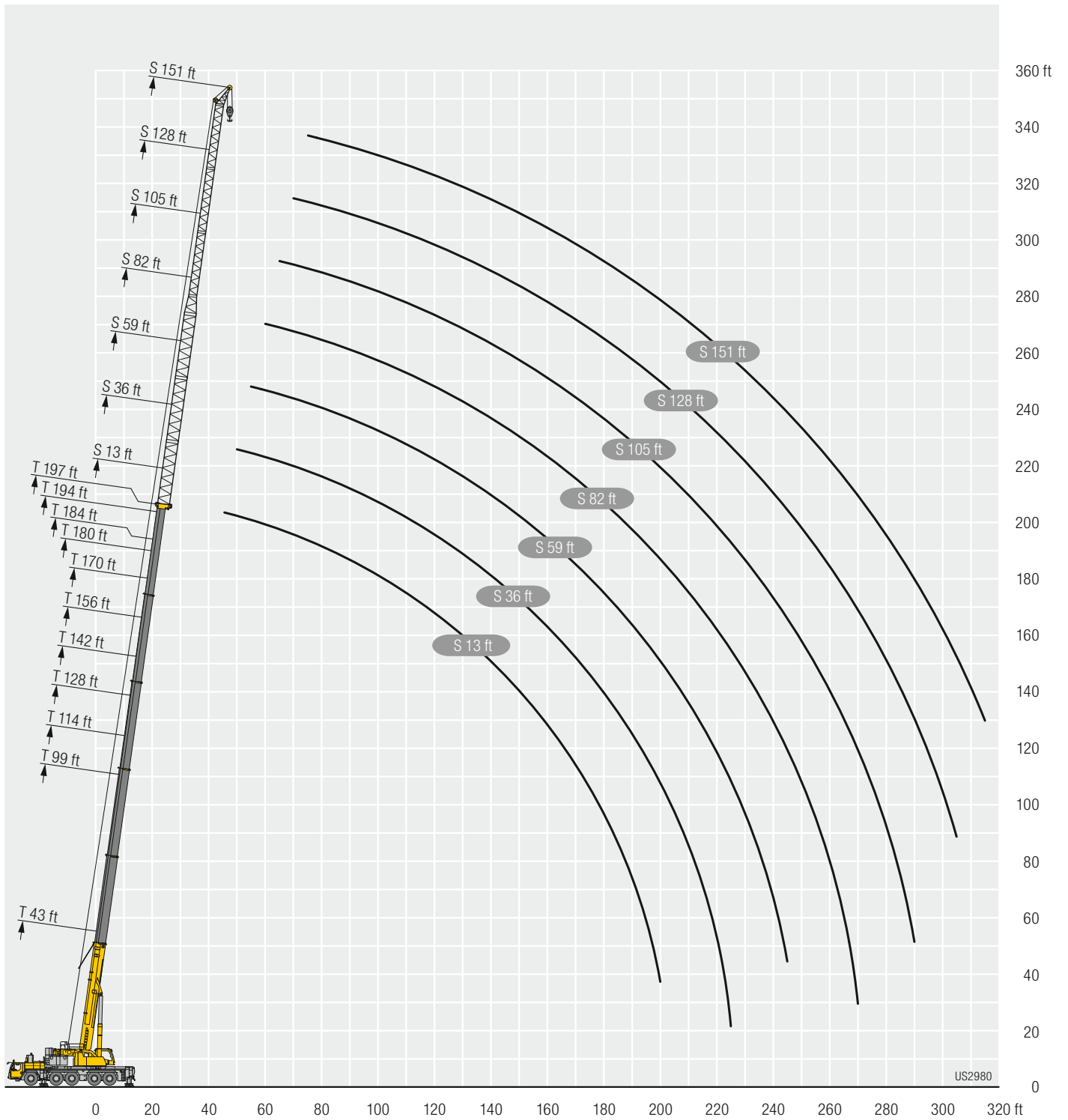

# Lifting capacities Forces de levage

TNZF



↙ ↘	43 ft + 3.3 ft*			99 ft + 3.3 ft*			114 ft + 3.3 ft*			128 ft + 3.3 ft*			142 ft + 3.3 ft*			156 ft + 3.3 ft*			↙ ↘
	0°	22.5°	45°	0°	22.5°	45°	0°	22.5°	45°	0°	22.5°	45°	0°	22.5°	45°	0°	22.5°	45°	
10	90.9																		10
11	90.9																		11
12	90.9																		12
13	90.9																		13
14	90																		14
15	88.5																		15
16	86.7																		16
17	85																		17
18	83.3																		18
19	81.6																		19
20	80.1	62.8																	20
22	76.9	61.9		90.9															22
24	73.9	60.1		90.9			88.5												24
26	70.9	58.2		89.7			87												26
28	68.1	56.5	49.3	87.7			85.5			79.2									28
30	65.3	54.9	48.4	85.8			83.9			78.3									30
32	62.6	53.4	47.5	83.9	62.1		82.4			77.3			69.9						32
34	60	52	46.6	82	61.1		80.9	60.8		76.3			69.3						34
36	57.5	50.5	45.8	80.3	60.1		79.4	59.9		75.2			68.7			60.2			36
38	55.2	48.9	44.9	78.5	59.1	49.2	78	59		74.2	57.8		68			59.9			38
40	53.2	47.5	44	76.7	58.1	48.7	76.4	58.2		73	57.1		67.3			59.5			40
45	48.6	44.2	41.8	72.6	55.8	47.5	72.7	56	47.5	70	55.2	47	65.1	53.4		58.3			45
50	44.8	41.4	40	68.6	53.7	46.4	69.3	54.1	46.5	67.2	53.4	46.2	63.1	51.8	45.4	57.1	49.4		50
55	41.7	39.3	38.8	64.7	51.9	45.4	66.2	52.3	45.6	64.7	51.9	45.3	61.2	50.5	44.7	55.8	48.3	43.8	55
60	39	37.7	38.6	61.1	49.8	44.2	63.3	50.7	44.8	62.3	50.4	44.6	59.1	49.2	44	54.2	47.3	43.1	60
65	36.8	36.9		57.6	47.9	43.1	60.5	49.1	43.8	60	49.1	43.9	56.8	48	43.4	51.6	46.3	42.6	65
70				54.5	46	42	57.6	47.5	42.8	57.8	47.8	43.1	54.2	47	42.9	49	45.4	42.1	70
75				51.7	44.3	41.1	54.7	46	41.8	54.8	46.6	42.3	51.1	46	42.3	46.6	44.4	41.7	75
80				49.4	42.8	40.3	52.4	44.5	41.1	51.3	45.3	41.5	47.8	45.1	41.5	44.3	42.8	41.2	80
85				47.1	41.5	39.5	50.1	43.1	40.3	48	44.1	40.7	45	44.2	40.8	42.1	40.9	40.2	85
90				45.1	40.3	39	48	41.9	39.7	45.1	42.8	40.1	42.2	42.5	40.2	40	39.1	38.7	90
95				43.3	39.3	38.7	45.4	40.8	39.2	42.2	41.4	39.5	39.7	40.2	39.1	37.8	37.4	37.3	95
100				41.7	38.5	38.6	42.2	39.8	38.8	39.9	40	39.1	37.5	37.9	37.8	35.7	35.7	35.7	100
105				40.2	37.8	38.6	39.1	39	38.5	37.5	38.1	38.2	35.3	35.8	36.3	33.7	34.1	34.2	105
110				38	37.2	38.3	36.4	37.1	37.3	34.9	35.7	36.1	33.3	33.8	34.3	31.9	32.4	32.7	110
115				35.6	35.8	35.6	33.9	34.5	34.6	32.3	33.2	33.5	31.5	32	32.4	30.2	30.7	31.1	115
120				30.5	31.8		31.7	32.1	32.1	30.1	30.8	31	30	30.2	30.6	28.6	29.1	29.5	120
125							29.6	30	29.8	28	28.6	28.8	28.8	28.5	28.7	27.1	27.5	27.9	125
130							27.7	28	27	26.2	26.7	26.7	27	27.4	27.6	25.6	26.1	26.5	130
135							22.1	22.5		24.4	24.8	24.8	25.2	25.7	25.9	24	24.6	24.9	135
140										22.8	23.1	22.9	23.6	24	24.1	22.8	23	23.2	140
145										21	21.6		22.1	22.5	22.5	22	21.9	22.2	145
150										15.9	16.2		20.7	21	20.9	20.9	21.2	21.3	150
155													19.5	19.7	19.4	19.7	20	20	155
160													17.2	17.9		18.5	18.8	18.7	160
165													13.7			17.4	17.6	17.5	165
170																16.3	16.5		170
175																15	15.3		175
180																8.1			180

\* adapter - pièce d'adaptateur

t\_259\_104\_10151 / 30151\_00\_000

# Lifting capacities Forces de levage

TNZF



Lifting height (ft)	170 ft + 3.3 ft*			180 ft + 3.3 ft*			184 ft + 3.3 ft*			194 ft + 3.3 ft*			197 ft + 3.3 ft*			Lifting height (ft)
	0°	22,5°	45°	0°	22,5°	45°	0°	22,5°	45°	0°	22,5°	45°	0°	22,5°	45°	
40	51.2															40
45	50.6			39.7			42									45
50	49.5			38.6			40.9			35.5			34.8			50
55	47.6	44.7		37.5	35.5		39.7			34.8			34.1			55
60	45.6	43.7	41.4	36.2	34.2		38.5	35.9		34	33		33.4	32.6		60
65	43.7	42	40.9	34.9	32.9	31.5	37.1	34.6	33.1	33.1	32		32.7	31.7		65
70	41.8	40.2	39.8	33.5	31.7	30.4	35.7	33.4	32.1	32.2	31	29.8	31.8	30.7	29.7	70
75	40.1	38.6	38.2	32	30.5	29.4	34.3	32.2	31.1	31.1	29.9	28.9	30.8	29.8	28.8	75
80	38.4	37	36.7	30.7	29.4	28.5	33	31.2	30.1	30	28.9	28.1	29.7	28.7	28	80
85	36.8	35.6	35.3	29.5	28.3	27.6	31.8	30.2	29.2	28.9	27.9	27.3	28.6	27.7	27.2	85
90	35.3	34.2	34	28.2	27.3	26.8	30.5	29.2	28.4	27.8	26.9	26.5	27.6	26.8	26.4	90
95	33.9	32.8	32.8	27	26.3	25.9	29.4	28.3	27.6	26.7	26	25.7	26.6	25.9	25.7	95
100	32.5	31.7	31.6	25.8	25.3	25.1	28.3	27.4	26.9	25.7	25.1	25	25.5	25	24.9	100
105	31.2	30.5	30.5	24.7	24.3	24.2	27.3	26.6	26.2	24.7	24.2	24.2	24.6	24.2	24.1	105
110	29.9	29.4	29.4	23.7	23.4	23.4	26.3	25.8	25.5	23.7	23.4	23.4	23.6	23.4	23.3	110
115	28.6	28.3	28.4	22.6	22.5	22.6	25.4	24.9	24.9	22.8	22.6	22.6	22.7	22.5	22.6	115
120	27.3	27.2	27.4	21.7	21.6	21.7	24.5	24.1	24.2	22	21.8	21.9	21.9	21.7	21.8	120
125	26	26.2	26.4	20.8	20.7	20.9	23.6	23.3	23.5	21.1	21	21.1	21.1	21	21.1	125
130	24.7	25.1	25.4	20	19.9	20.1	22.9	22.6	22.8	20.3	20.2	20.4	20.3	20.2	20.4	130
135	23.5	24	24.3	19.2	19.2	19.3	22.1	21.9	22.1	19.6	19.5	19.7	19.6	19.5	19.7	135
140	22.4	22.8	23.1	18.4	18.4	18.6	21.3	21.2	21.4	18.9	18.8	19	18.9	18.8	19	140
145	21.1	21.6	21.9	17.7	17.7	17.9	20.6	20.5	20.8	18.2	18.1	18.4	18.2	18.2	18.4	145
150	19.8	20.3	20.5	17	17	17.2	19.9	19.9	20.1	17.5	17.5	17.7	17.5	17.5	17.8	150
155	18.7	19	19.1	16.4	16.4	16.6	19.1	19.3	19.5	16.9	16.9	17.1	16.9	16.9	17.2	155
160	18	18.1	18.3	15.8	15.8	16	18	18.5	18.7	16.3	16.3	16.6	16.2	16.4	16.6	160
165	17.4	17.5	17.8	15.2	15.3	15.4	16.9	17.3	17.4	15.8	15.8	16	15.6	15.8	16	165
170	16.8	16.9	17.2	14.6	14.7	14.9	15.8	16.2	16.3	15.2	15.3	15.5	15	15.2	15.4	170
175	15.9	16.2	16.1	14.1	14.2	14.4	14.8	15.2	15.2	14.7	14.8	15	14.4	14.6	14.8	175
180	15	15.2	15	13.5	13.6	13.8	13.9	14.2	14.2	13.9	14.2	14.3	13.7	14	14.1	180
185	14	14.2		13.1	13.1	13.3	13	13.3	13.2	13	13.3	13.3	12.8	13.2	13.2	185
190	10.9	11.1		12.6	12.7		12.2	12.4	12.2	12.2	12.5	12.4	12	12.3	12.3	190
195				12.1	12.3		11.4	11.5		11.4	11.6	11.5	11.2	11.5	11.4	195
200				9.2	9.3		10.2	10.5		10.7	10.8	10.7	10.5	10.7	10.6	200
205							7	6.9		10	10.1		9.8	9.9	9.8	205
210										8.6	9		9	9.2		210
215										5.8			6.8	7		215
220													3			220

\* adapter - pièce d'adaptateur

t\_259\_104\_10151 / 30151\_00\_000

# Lifting capacities Forces de levage

TNZF

43 ft + 3.3 ft*	99 ft + 3.3 ft*			114 ft + 3.3 ft*			128 ft + 3.3 ft*			142 ft + 3.3 ft*			156 ft + 3.3 ft*			49 ft			
	0°	22.5°	45°	0°	22.5°	45°	0°	22.5°	45°	0°	22.5°	45°	0°	22.5°	45°				
14	60.9															14			
15	60.9															15			
16	60.2															16			
17	59.1															17			
18	58															18			
19	57															19			
20	56															20			
22	54															22			
24	51.9															24			
26	49.9			60.1												26			
28	48			58.7			57									28			
30	46.2			57.4			56									30			
32	44.4			56.1			55			51.8						32			
34	42.7	32.1		54.9			54			51.1						34			
36	41	31		53.6			52.9			50.4			46			36			
38	39.3	30		52.4			51.8			49.5			45.7			38			
40	37.6	29		51.1			50.7			48.6			45.3		40.7	40			
45	34.1	26.8		48	31.8		48			46.4			43.7		39.6	45			
50	31	25	20.9	45.2	30.2		45.5	30.5		44.3	30.4		42.1		38.5	50			
55	28.4	23.5	20	42.6	28.7		43.2	29.1		42.3	29.2		40.6	29.7	37.4	55			
60	26.2	22.1	19.3	40	27.4	21.1	41.1	27.9	21.2	40.5	28		39.1	28.6	36.3	27.9	60		
65	24.3	21	18.7	37.3	26.2	20.6	39	26.8	20.7	38.9	27	20.7	37.7	27.5	35.2	27	65		
70	22.7	20	18.2	35.1	25.2	20.1	36.7	25.8	20.2	37.2	26	20.2	36.4	26.6	20.6	34.2	26.2	70	
75	21.2	19.2	18.1	33.1	24.2	19.6	34.7	24.8	19.8	35.5	25.1	19.8	35.2	25.7	20.3	33.3	25.4	20.1	75
80	20	18.5	18.1	31.2	23.3	19.3	32.9	24	19.4	33.8	24.3	19.5	34	25	19.9	32.3	24.7	19.8	80
85	18.9	18.2		29.5	22.6	18.9	31.2	23.2	19.1	32.2	23.5	19.2	32.8	24.2	19.6	31.5	24	19.5	85
90	18.2			28	21.8	18.6	29.7	22.5	18.8	30.8	22.8	18.9	31.5	23.6	19.3	30.6	23.4	19.2	90
95				26.6	21.2	18.4	28.3	21.8	18.5	29.3	22.2	18.6	30.4	22.9	19	29.7	22.8	19	95
100				25.3	20.6	18.2	27	21.2	18.3	28.1	21.6	18.4	29.2	22.3	18.8	28.8	22.3	18.7	100
105				24.3	20	18.1	25.9	20.6	18.2	27	21	18.2	28.1	21.8	18.6	27.9	21.8	18.5	105
110				23.2	19.5	18.1	24.8	20.1	18	25.9	20.5	18.1	27.1	21.3	18.4	27	21.3	18.4	110
115				22.3	19.1	18.1	23.8	19.7	17.9	24.9	20.1	17.9	26.1	20.8	18.3	26.1	20.8	18.2	115
120				21.4	18.7	18.1	22.9	19.3	17.9	24	19.7	17.9	25.2	20.4	18.2	25.3	20.4	18.1	120
125				20.6	18.4	18.1	22	18.9	17.9	23.2	19.3	17.8	24.4	20	18.1	24.6	20.1	18.1	125
130				19.9	18.3		21.2	18.6	17.9	22.4	18.9	17.8	23.6	19.6	18.1	23.8	19.7	18	130
135				19.2	18.2		20.5	18.3	17.9	21.7	18.6	17.8	22.8	19.3	18.1	23.1	19.4	18	135
140				18.6	18.2		19.9	18.2	17.9	21	18.4	17.8	22.2	19	18.1	22.2	19.1	18	140
145				18.2			19.3	18.1		20.4	18.2	17.8	21.6	18.8	18.1	21.4	18.9	18	145
150							18.8	18.1		19.8	18	17.8	20.8	18.6	18.1	20.4	18.7	18	150
155							18.4	18.1		19.3	18	17.8	20.2	18.4	18.1	19.1	18.5	18	155
160							12.9			18.6	18		19.1	18.3	18.1	17.9	18.3	18	160
165										17.4	17.8		18	18.2	18.1	16.9	17.6	17.9	165
170										14.3	15.7		16.9	17.4	17.3	16.3	16.4	16.7	170
175										9.2			15.9	16.3		15.7	15.8	16.2	175
180													14.8	15.3		15	15.3	15.5	180
185													12	11		14.2	14.6	13.1	185
190																13.3	13.7		190
195																12	12.8		195
200																9.7			200

\* adapter - pièce d'adaptateur

t\_259\_104\_11151 / 31151\_00\_000

# Lifting capacities Forces de levage

TNZF

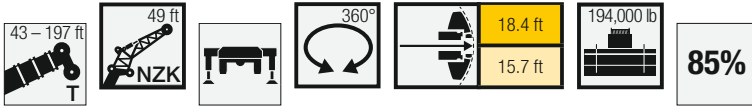

45°	170 ft + 3.3 ft*			180 ft + 3.3 ft*			184 ft + 3.3 ft*			194 ft + 3.3 ft*			197 ft + 3.3 ft*			45°
	0°	22,5°	45°	0°	22,5°	45°	0°	22,5°	45°	0°	22,5°	45°	0°	22,5°	45°	
45	34.8															45
50	34.1			29.2			29.5									50
55	33.4			28.7			29.1			26.3			25.6			55
60	32.7			28.3			28.6			25.9			25.3			60
65	32	26		27.6			28.2			25.6			25.1			65
70	31.3	25.3		26.8	23		27.8	23.7		25.3			24.8			70
75	30.6	24.7		26	22.3		27.3	23		24.7	22		24.4	21.8		75
80	29.9	24	19.5	25.2	21.7		26.6	22.4		24.1	21.4		23.9	21.3		80
85	29.2	23.4	19.2	24.4	21.1	18.5	25.7	21.8	18.8	23.6	20.9		23.3	20.8		85
90	28.6	22.9	19	23.5	20.6	18.2	24.9	21.2	18.6	22.9	20.4	18.1	22.7	20.3	18	90
95	28	22.4	18.8	22.7	20.1	17.9	24	20.7	18.3	22.3	19.9	17.8	22.1	19.8	17.8	95
100	27.2	21.9	18.6	21.9	19.6	17.6	23.2	20.2	18.1	21.6	19.5	17.5	21.5	19.4	17.5	100
105	26.3	21.4	18.4	21.1	19.1	17.3	22.4	19.8	17.8	20.9	19	17.3	20.8	19	17.2	105
110	25.4	21	18.3	20.3	18.6	17.1	21.7	19.4	17.6	20.1	18.6	17	20.1	18.5	17	110
115	24.5	20.6	18.1	19.6	18.1	16.9	21	19	17.4	19.5	18.1	16.8	19.4	18	16.8	115
120	23.7	20.2	18	18.9	17.6	16.7	20.4	18.6	17.2	18.8	17.6	16.6	18.8	17.5	16.6	120
125	22.8	19.9	17.9	18.2	17.1	16.5	19.8	18.2	17	18.2	17.1	16.4	18.2	17.1	16.4	125
130	22	19.6	17.9	17.6	16.7	16.2	19.2	17.8	16.8	17.6	16.7	16.2	17.5	16.7	16.2	130
135	21.3	19.3	17.8	16.9	16.2	15.9	18.6	17.4	16.6	17	16.3	16	17	16.3	15.9	135
140	20.6	19.1	17.8	16.3	15.8	15.6	18	16.9	16.5	16.4	15.9	15.7	16.4	15.9	15.6	140
145	19.9	18.8	17.8	15.6	15.4	15.3	17.5	16.5	16.2	15.8	15.5	15.4	15.8	15.5	15.3	145
150	19.2	18.6	17.8	15	14.9	15	16.9	16.1	16	15.3	15.1	15.1	15.3	15.1	15	150
155	18.6	18.3	17.8	14.4	14.5	14.6	16.4	15.8	15.8	14.8	14.7	14.7	14.8	14.7	14.7	155
160	17.8	17.9	17.8	13.9	14	14.2	15.9	15.4	15.5	14.2	14.2	14.4	14.2	14.3	14.4	160
165	16.9	17.4	17.6	13.4	13.5	13.8	15.4	15.1	15.3	13.7	13.8	14	13.7	13.8	14.1	165
170	15.8	16.7	17	12.9	13	13.3	15	14.8	15	13.3	13.3	13.6	13.3	13.4	13.7	170
175	14.8	15.6	15.9	12.4	12.5	12.8	14.5	14.4	14.8	12.8	12.9	13.2	12.8	12.9	13.2	175
180	13.9	14.6	14.8	12	12.1	12.4	14.1	14.1	14.5	12.4	12.5	12.8	12.4	12.5	12.8	180
185	13.3	13.6	13.8	11.5	11.6	11.9	13.4	13.7	14.2	12	12.1	12.4	12	12.1	12.4	185
190	12.9	13	13.5	11.1	11.2	11.5	12.5	13.2	13.4	11.6	11.7	12	11.6	11.7	12	190
195	12.5	12.7	13.1	10.7	10.9	11.2	11.7	12.3	12.5	11.2	11.3	11.6	11.2	11.4	11.7	195
200	12.1	12.3		10.4	10.5	10.8	11	11.5	11.6	10.8	11	11.3	10.7	11	11.3	200
205	11.4	11.7		10	10.2	10.5	10.3	10.8	10.7	10.2	10.7	10.8	10	10.6	10.7	205
210	9.6	10.6		9.7	9.9		9.6	10	9.9	9.6	10	10.1	9.4	9.9	9.9	210
215	6.3			9.4	9.6		9	9.3		8.9	9.4	9.3	8.7	9.2	9.2	215
220				8.1	8.9		8.2	8.6		8.3	8.7	8.5	8.1	8.5	8.4	220
225				5.2			6.4			7.8	8		7.6	7.9		225
230							3.3			7	7.5		7.1	7.3		230
235										5.3			5.9	6.5		235
240													3.6			240

\* adapter - pièce d'adaptateur

t\_259\_104\_11151 / 31151\_00\_000

# Lifting capacities Forces de levage

TNZF



Lifting height (ft)	43 ft + 3.3 ft*			99 ft + 3.3 ft*			114 ft + 3.3 ft*			128 ft + 3.3 ft*			142 ft + 3.3 ft*			156 ft + 3.3 ft*			Lifting height (ft)
	0°	22.5°	45°	0°	22.5°	45°	0°	22.5°	45°	0°	22.5°	45°	0°	22.5°	45°	0°	22.5°	45°	
18	43																		18
19	43																		19
20	42.6																		20
22	41.4																		22
24	40.1																		24
26	38.8																		26
28	37.5																		28
30	36.1			42.5															30
32	34.9			41.7			40.5												32
34	33.7			40.9			39.8												34
36	32.6			40			39.1			37									36
38	31.6			39.2			38.4			36.4									38
40	30.6			38.3			37.6			35.8			33.1						40
45	28.3	23.7		36			35.6			34.2			32			29.1			45
50	26.2	22.6		34			33.8			32.7			30.8			28.2			50
55	24.3	21.2		32.1			32.1			31.2			29.7			27.4			55
60	22.5	20		30.4	23		30.6	22.8		29.9			28.6			26.5			60
65	20.8	18.9		28.9	22		29.2	22		28.6	21.8		27.5			25.7			65
70	19.1	18	16.3	27.4	21.1		27.8	21.2		27.4	21		26.5	20.6		24.9			70
75	17.7	17.1	15.6	26.1	20.3		26.6	20.5		26.3	20.3		25.5	19.9		24.1	19.3		75
80	16.5	16.3	15	24.8	19.6	16.5	25.4	19.8	16.6	25.3	19.7		24.6	19.4		23.4	18.8		80
85	15.4	15.5	14.5	23.6	19	16.1	24.3	19.1	16.1	24.3	19.1	16.1	23.8	18.8		22.7	18.3		85
90	14.4	14.8	14.1	22.3	18.3	15.7	23.3	18.5	15.8	23.4	18.5	15.7	23	18.3	15.6	22	17.8		90
95	13.6	14.2	13.8	21.2	17.8	15.3	22.3	18	15.4	22.5	18	15.4	22.2	17.8	15.3	21.4	17.4	15.1	95
100	12.8	13.7	13.6	20	17.2	15	21.3	17.5	15.1	21.8	17.5	15.1	21.5	17.3	15	20.7	17	14.8	100
105	12.2	13.3	13.6	19	16.7	14.7	20.3	17	14.8	21	17	14.8	20.8	16.9	14.7	20.2	16.6	14.6	105
110	11.6	13.2		18.1	16.2	14.4	19.3	16.5	14.5	20.2	16.6	14.5	20.2	16.5	14.5	19.6	16.2	14.3	110
115				17.1	15.7	14.2	18.4	16.1	14.3	19.3	16.2	14.3	19.5	16.1	14.3	19.1	15.9	14.1	115
120				16.4	15.2	14	17.6	15.6	14.1	18.5	15.8	14.1	18.9	15.8	14.1	18.6	15.6	13.9	120
125				15.7	14.8	13.8	16.8	15.2	13.9	17.7	15.5	13.9	18.3	15.4	13.9	18.1	15.2	13.8	125
130				15	14.5	13.7	16.1	14.8	13.8	17	15.1	13.8	17.6	15.1	13.7	17.6	14.9	13.6	130
135				14.4	14.1	13.7	15.5	14.5	13.6	16.4	14.8	13.6	17	14.8	13.6	17.1	14.7	13.5	135
140				13.8	13.8	13.6	14.9	14.2	13.6	15.8	14.4	13.5	16.4	14.5	13.5	16.6	14.4	13.4	140
145				13.3	13.6	13.6	14.3	13.9	13.5	15.2	14.1	13.5	15.8	14.2	13.4	16.1	14.1	13.3	145
150				12.8	13.4		13.8	13.6	13.5	14.6	13.9	13.4	15.3	14	13.3	15.6	13.9	13.2	150
155				12.3	13.2		13.3	13.4	13.5	14.1	13.6	13.4	14.8	13.7	13.3	15.2	13.7	13.1	155
160				11.9	13.2		12.9	13.2		13.7	13.4	13.4	14.3	13.5	13.2	14.7	13.5	13.1	160
165				11.6	13.2		12.4	13.1		13.2	13.2	13.4	13.9	13.3	13.2	14.3	13.3	13.1	165
170							12.1	13.1		12.8	13.1	13.4	13.5	13.1	13.2	13.9	13.1	13.1	170
175							11.7	13.1		12.5	12.9		13.1	13	13.2	13.5	12.9	13.1	175
180							11.5	13.1		12.1	12.9		12.7	12.9	13.2	13.2	12.8	13.1	180
185										11.8	12.9		12.4	12.7	13.2	12.8	12.7	13.1	185
190										11.6			12.1	12.7		12.4	12.6	13.1	190
195										8.8			11.8	12.7		12	12.4	12.7	195
200													11.6	12.6		11.7	11.8	12.4	200
205													10.1			11.4	11.5		205
210													8.4			10.7	11.2		210
215																9.9	10.4		215
220																8.6			220
225																5.3			225

\* adapter - pièce d'adaptateur

t\_259\_104\_13151 / 33151\_00\_000

# Lifting capacities Forces de levage

TNZF



72 ft	170 ft + 3.3 ft*			180 ft + 3.3 ft*			184 ft + 3.3 ft*			194 ft + 3.3 ft*			197 ft + 3.3 ft*			72 ft
	0°	22,5°	45°	0°	22,5°	45°	0°	22,5°	45°	0°	22,5°	45°	0°	22,5°	45°	
50	25															50
55	24.5			20.5			20.9			18.8			18.5			55
60	23.9			20.2			20.5			18.6			18.3			60
65	23.3			19.9			20.2			18.4			18.1			65
70	22.7			19.6			19.8			18.1			17.8			70
75	22.2			19.2			19.5			17.9			17.6			75
80	21.6	17.9		18.9			19.2			17.6			17.4			80
85	21	17.4		18.6	15.6		18.8	16.1		17.4			17.1			85
90	20.5	17		18.2	15.2		18.5	15.7		17.1	15		16.9	14.9		90
95	20	16.7		17.8	14.8		18.2	15.2		16.8	14.6		16.6	14.5		95
100	19.5	16.3	14.5	17.4	14.4	12.3	17.8	14.9		16.6	14.2		16.4	14.2		100
105	19	16	14.3	16.9	14	12.1	17.5	14.5	12.4	16.3	13.9	12	16.1	13.8		105
110	18.6	15.7	14	16.4	13.6	11.9	17.2	14.1	12.2	15.9	13.5	11.8	15.8	13.5	11.8	110
115	18.1	15.3	13.9	15.9	13.3	11.7	16.8	13.8	12	15.5	13.2	11.6	15.4	13.2	11.6	115
120	17.7	15.1	13.7	15.4	13	11.5	16.4	13.4	11.8	15.1	12.9	11.4	15	12.9	11.4	120
125	17.3	14.8	13.6	14.9	12.7	11.3	15.9	13.1	11.6	14.7	12.6	11.2	14.7	12.6	11.2	125
130	17	14.5	13.4	14.5	12.4	11.1	15.4	12.9	11.4	14.3	12.4	11.1	14.3	12.4	11.1	130
135	16.6	14.3	13.3	14	12.1	11	15	12.6	11.3	13.9	12.1	10.9	13.9	12.1	10.9	135
140	16.3	14.1	13.2	13.6	11.9	10.9	14.5	12.3	11.2	13.5	11.9	10.8	13.5	11.9	10.8	140
145	15.9	13.9	13.1	13.1	11.7	10.7	14.1	12.1	11.1	13.1	11.7	10.7	13.1	11.7	10.7	145
150	15.5	13.7	13	12.7	11.4	10.6	13.7	11.8	10.9	12.8	11.4	10.6	12.7	11.4	10.6	150
155	15.2	13.5	13	12.3	11.2	10.5	13.3	11.6	10.8	12.4	11.2	10.5	12.4	11.2	10.5	155
160	14.8	13.3	12.9	12	11	10.4	12.9	11.4	10.8	12	11	10.4	12	11	10.4	160
165	14.5	13.1	12.9	11.6	10.8	10.4	12.6	11.2	10.7	11.7	10.8	10.3	11.7	10.8	10.3	165
170	14.1	12.9	12.9	11.2	10.6	10.3	12.2	11.1	10.6	11.3	10.6	10.3	11.3	10.6	10.2	170
175	13.7	12.8	12.9	10.9	10.4	10.2	11.9	10.9	10.6	11	10.4	10.2	11	10.4	10.2	175
180	13.4	12.7	12.9	10.5	10.1	10.1	11.6	10.7	10.5	10.7	10.2	10.2	10.6	10.2	10.1	180
185	13.1	12.5	12.9	10.1	9.9	10	11.3	10.6	10.5	10.3	10	10.1	10.3	10	10	185
190	12.4	12.4	12.9	9.7	9.7	9.9	11	10.4	10.5	10	9.8	9.9	10	9.8	9.9	190
195	11.7	12.2	12.9	9.4	9.5	9.7	10.7	10.3	10.5	9.6	9.6	9.8	9.6	9.6	9.8	195
200	10.9	11.9	12.2	9	9.2	9.5	10.5	10.1	10.4	9.3	9.4	9.6	9.3	9.4	9.7	200
205	10.2	11.1	11.3	8.7	8.9	9.2	10.2	10	10.4	9	9.1	9.4	9	9.1	9.4	205
210	9.7	10.3	10.4	8.4	8.6	8.9	9.9	9.8	10.3	8.7	8.8	9.1	8.7	8.8	9.2	210
215	9.4	9.6		8.1	8.3	8.6	9.3	9.6	10.1	8.4	8.6	8.9	8.4	8.6	8.9	215
220	9.1	9.3		7.8	8	8.2	8.7	9.4	9.5	8.1	8.3	8.6	8.1	8.3	8.7	220
225	8.9	9.1		7.5	7.7		8.1	8.8	8.7	7.9	8	8.3	7.8	8.1	8.4	225
230	8.2	7.5		7.3	7.5		7.6	8.1		7.5	7.8	8.1	7.4	7.8	8.1	230
235	6.1			7.1	7.3		7.2	7.5		7.1	7.5		6.9	7.4	7.4	235
240				6.8	7.1		6.7	7		6.6	7.1		6.5	6.9		240
245				5.1			5.5			6.2	6.6		6.1	6.5		245
250							3.5			5.8	6.1		5.7	6		250
255										4.5			4.9	5.5		255
260										2.4			3.2			260

\* adapter - pièce d'adaptateur

t\_259\_104\_13151 / 33151\_00\_000

# Lifting capacities Forces de levage

TNZF



Lifting height (ft)	43 ft + 3.3 ft*			99 ft + 3.3 ft*			114 ft + 3.3 ft*			128 ft + 3.3 ft*			142 ft + 3.3 ft*			156 ft + 3.3 ft*			Lifting height (ft)
	0°	22.5°	45°	0°	22.5°	45°	0°	22.5°	45°	0°	22.5°	45°	0°	22.5°	45°	0°	22.5°	45°	
22	31.3																		22
24	31.2																		24
26	30.4																		26
28	29.5																		28
30	28.6																		30
32	27.8																		32
34	26.9			31.1															34
36	26.1			30.6			29.6												36
38	25.4			30			29.1												38
40	24.6			29.3			28.6			26.9									40
45	22.9			27.8			27.3			26			24.2						45
50	21.4			26.3			26			24.9			23.4			21.3			50
55	19.9			25			24.7			23.9			22.6			20.8			55
60	18.5	16.3		23.7			23.6			22.9			21.7			20.2			60
65	17.2	15.4		22.5			22.5			22			20.9			19.6			65
70	15.8	14.5		21.5	16.3		21.5			21.1			20.2			19			70
75	14.6	13.8		20.4	15.7		20.6	15.7		20.2			19.4			18.5			75
80	13.5	13		19.4	15.1		19.6	15.1		19.4	14.9		18.8			17.9			80
85	12.6	12.3	11.1	18.4	14.5		18.8	14.6		18.7	14.4		18.1	14.1		17.4			85
90	11.7	11.7	10.6	17.5	14		18	14		17.9	14		17.5	13.7		16.9	13.6		90
95	11	11.1	10.2	16.5	13.5		17.2	13.6		17.2	13.5		16.9	13.3		16.4	13.2		95
100	10.3	10.5	9.8	15.6	13	10.8	16.4	13.1	10.8	16.6	13.1		16.3	12.9		15.9	12.9		100
105	9.7	10.1	9.5	14.7	12.5	10.5	15.6	12.7	10.5	15.9	12.7	10.5	15.7	12.5		15.5	12.5		105
110	9.1	9.7	9.2	13.9	12.1	10.2	14.8	12.3	10.3	15.3	12.3	10.2	15.2	12.2	10.1	15	12.2		110
115	8.6	9.3	9	13.2	11.7	10	14.1	11.9	10	14.6	11.9	10	14.7	11.9	9.9	14.6	12	10.4	115
120	8.1	8.9	8.8	12.5	11.3	9.8	13.4	11.5	9.8	14	11.6	9.8	14.1	11.5	9.7	14.2	11.7	10.2	120
125	7.7	8.6	8.8	12	10.9	9.5	12.8	11.2	9.6	13.4	11.2	9.6	13.6	11.2	9.6	13.8	11.4	10.1	125
130	7.4	8.5		11.4	10.5	9.4	12.2	10.8	9.4	12.8	10.9	9.4	13.1	10.9	9.4	13.4	11.2	9.9	130
135	7.2			10.9	10.2	9.2	11.6	10.5	9.3	12.2	10.6	9.3	12.6	10.6	9.2	13.1	10.9	9.7	135
140				10.4	9.9	9.1	11.1	10.2	9.1	11.7	10.3	9.1	12.1	10.4	9.1	12.7	10.7	9.6	140
145				9.9	9.7	9	10.7	9.9	9	11.2	10.1	9	11.7	10.1	9	12.4	10.5	9.5	145
150				9.5	9.4	8.9	10.2	9.7	8.9	10.8	9.8	8.9	11.2	9.9	8.9	12.1	10.2	9.3	150
155				9.1	9.2	8.8	9.8	9.4	8.8	10.4	9.6	8.8	10.8	9.6	8.8	11.8	10.1	9.2	155
160				8.7	9	8.8	9.4	9.2	8.7	10	9.3	8.7	10.4	9.4	8.7	11.5	9.9	9.1	160
165				8.4	8.8	8.8	9.1	9	8.7	9.6	9.1	8.7	10	9.2	8.6	11.2	9.7	9.1	165
170				8.1	8.6		8.7	8.8	8.7	9.3	8.9	8.6	9.7	9	8.5	10.8	9.5	9	170
175				7.8	8.5		8.4	8.6	8.7	8.9	8.8	8.6	9.4	8.9	8.5	10.5	9.4	8.9	175
180				7.5	8.5		8.1	8.5		8.6	8.6	8.6	9.1	8.7	8.5	10.1	9.2	8.9	180
185				7.3	8.5		7.9	8.4		8.4	8.5	8.6	8.8	8.5	8.5	9.8	9.1	8.9	185
190				7.2			7.6	8.4		8.1	8.4	8.6	8.5	8.4	8.5	9.5	8.9	8.9	190
195							7.4	8.4		7.9	8.3		8.2	8.3	8.5	9.3	8.8	8.9	195
200							7.3			7.6	8.3		8	8.2	8.5	9	8.7	8.9	200
205							7.2			7.5	8.2		7.8	8.2	8.5	8.7	8.6	8.9	205
210										7.3	8.2		7.6	8.1		8.5	8.5	8.9	210
215										7.2			7.5	8.1		8.3	8.5	8.9	215
220										6.6			7.3	8.1		8.1	8.4	8.9	220
225													7.2	8.1		7.9	8.4		225
230													6.7			7.7	8.4		230
235													3.5			7.6	8.4		235
240																6.9			240
245																5.7			245

\* adapter - pièce d'adaptateur

t\_259\_104\_15151 / 35151\_00\_000



# Lifting capacities Forces de levage

TNZF

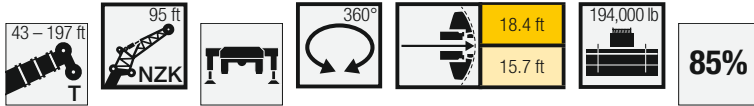

↙	170 ft + 3.3 ft*			180 ft + 3.3 ft*			184 ft + 3.3 ft*			194 ft + 3.3 ft*			197 ft + 3.3 ft*			↘
	0°	22,5°	45°	0°	22,5°	45°	95 ft			0°	22,5°	45°	0°	22,5°	45°	
55	18,4															55
60	18			15,3			15,6			14,1						60
65	17,6			15			15,3			13,9			13,6			65
70	17,2			14,8			15			13,7			13,4			70
75	16,8			14,5			14,7			13,5			13,2			75
80	16,4			14,2			14,4			13,3			13			80
85	15,9			14			14,2			13			12,8			85
90	15,6			13,7			13,9			12,8			12,6			90
95	15,2	12,6		13,4			13,6			12,6			12,4			95
100	14,8	12,3		13,2	11		13,3	11,3		12,4			12,2			100
105	14,4	12		12,9	10,6		13,1	11		12,2	10,5		12	10,5		105
110	14,1	11,7		12,6	10,3		12,8	10,7		11,9	10,2		11,8	10,2		110
115	13,7	11,5		12,4	10,1		12,5	10,4		11,7	10		11,6	9,9		115
120	13,4	11,2	10	12,1	9,8		12,3	10,1		11,5	9,7		11,4	9,7		120
125	13,1	11	9,8	11,9	9,5	8	12	9,9	8,3	11,3	9,4	8	11,2	9,4		125
130	12,8	10,7	9,7	11,6	9,3	7,9	11,8	9,6	8,1	11,1	9,2	7,9	11	9,2	7,8	130
135	12,5	10,5	9,6	11,2	9	7,8	11,6	9,4	8	10,9	9	7,7	10,8	9	7,7	135
140	12,2	10,4	9,4	10,9	8,8	7,6	11,3	9,1	7,9	10,7	8,8	7,6	10,6	8,8	7,6	140
145	11,9	10,2	9,3	10,6	8,6	7,5	11,1	8,9	7,7	10,5	8,6	7,5	10,4	8,6	7,5	145
150	11,6	10	9,2	10,3	8,4	7,4	10,8	8,7	7,6	10,3	8,4	7,4	10,2	8,4	7,4	150
155	11,4	9,8	9,1	10	8,2	7,3	10,5	8,5	7,5	10	8,2	7,3	10	8,2	7,3	155
160	11,1	9,6	9	9,7	8	7,3	10,2	8,3	7,4	9,8	8	7,2	9,7	8	7,2	160
165	10,9	9,5	8,9	9,5	7,9	7,2	9,9	8,2	7,4	9,5	7,9	7,2	9,5	7,9	7,2	165
170	10,7	9,3	8,9	9,2	7,7	7,1	9,6	8	7,3	9,3	7,7	7,1	9,2	7,7	7,1	170
175	10,4	9,2	8,8	8,9	7,6	7,1	9,4	7,8	7,2	9	7,6	7	9	7,6	7	175
180	10,2	9,1	8,8	8,7	7,4	7	9,1	7,7	7,2	8,8	7,5	7	8,8	7,5	7	180
185	9,9	8,9	8,7	8,4	7,3	7	8,9	7,6	7,1	8,5	7,4	6,9	8,5	7,3	7	185
190	9,7	8,8	8,7	8,2	7,2	6,9	8,7	7,4	7,1	8,3	7,2	6,9	8,3	7,2	6,9	190
195	9,4	8,7	8,7	8	7,1	6,9	8,5	7,3	7,1	8,1	7,1	6,9	8,1	7,1	6,9	195
200	9,2	8,6	8,7	7,7	7	6,9	8,3	7,3	7,1	7,9	7	6,9	7,9	7	6,9	200
205	9	8,5	8,7	7,5	6,9	6,9	8,1	7,2	7,1	7,7	7	6,8	7,7	7	6,9	205
210	8,7	8,4	8,7	7,3	6,8	6,9	7,9	7,1	7,1	7,5	6,9	6,8	7,5	6,9	6,8	210
215	8,5	8,4	8,7	7,1	6,8	6,9	7,7	7	7,1	7,3	6,8	6,8	7,3	6,8	6,8	215
220	8,3	8,3	8,7	6,9	6,7	6,9	7,6	6,9	7,1	7,1	6,8	6,8	7,1	6,7	6,8	220
225	8,1	8,3	8,7	6,7	6,6	6,9	7,4	6,9	7,1	6,9	6,7	6,8	6,9	6,7	6,8	225
230	7,6	8,3	8,6	6,5	6,6	6,9	7,3	6,9	7,1	6,7	6,6	6,8	6,7	6,6	6,8	230
235	7,2	7,9		6,2	6,5	6,7	7,2	6,8	7,1	6,5	6,5	6,8	6,5	6,6	6,8	235
240	6,9	7,3		6,1	6,3		6,9	6,8	7,1	6,3	6,4	6,7	6,3	6,4	6,8	240
245	6,7	6,8		5,9	6,1		6,5	6,8		6,1	6,3	6,6	6,1	6,3	6,6	245
250	6,6	6,8		5,7	5,9		6,1	6,6		5,9	6,1	6,4	5,8	6,1	6,4	250
255	5,4			5,5	5,7		5,7	6,2		5,6	5,9		5,4	6	6,1	255
260	3,4			5,4			5,3	5,7		5,2	5,7		5,1	5,6		260
265				4,5			4,6			4,9	5,3		4,7	5,2		265
270				2,2			3			4,5	4,9		4,3	4,8		270
275										3,6			3,8	4,3		275
280													2,4			280

\* adapter - pièce d'adaptateur

t\_259\_104\_15151 / 35151\_00\_000

# Lifting capacities Forces de levage

TNZF



Crane Height (ft)	43 ft + 3.3 ft*			99 ft + 3.3 ft*			114 ft + 3.3 ft*			128 ft + 3.3 ft*			142 ft + 3.3 ft*			156 ft + 3.3 ft*			Crane Height (ft)
	0°	22.5°	45°	0°	22.5°	45°	0°	22.5°	45°	0°	22.5°	45°	0°	22.5°	45°	0°	22.5°	45°	
26	22.9																		26
28	22.8																		28
30	22.3																		30
32	21.8																		32
34	21.4																		34
36	20.9																		36
38	20.4			22.8															38
40	19.9			22.4			21.6												40
45	18.7			21.5			20.9			19.7									45
50	17.6			20.6			20.1			19.1			17.8						50
55	16.6			19.7			19.3			18.5			17.3			15.7			55
60	15.6			18.9			18.5			17.8			16.7			15.3			60
65	14.7			18			17.8			17.2			16.2			14.9			65
70	13.8			17.2			17.1			16.5			15.7			14.5			70
75	13	11.7		16.5			16.4			15.9			15.2			14.1			75
80	12.2	11		15.7			15.7			15.3			14.7			13.7			80
85	11.4	10.5		15	11.8		15.1			14.8			14.2			13.3			85
90	10.6	9.9		14.4	11.4		14.5	11.3		14.2			13.7			12.9			90
95	9.9	9.5		13.8	10.9		13.9	10.9		13.7	10.8		13.3	10.5		12.5			95
100	9.2	9		13.1	10.5		13.3	10.5		13.2	10.4		12.9	10.2		12.2	9.8		100
105	8.6	8.5	7.8	12.6	10.1		12.8	10.2		12.7	10.1		12.4	9.8		11.8	9.5		105
110	8	8.1	7.5	12	9.8		12.3	9.8		12.3	9.7		12	9.6		11.5	9.2		110
115	7.5	7.7	7.2	11.4	9.4		11.8	9.5		11.8	9.4		11.6	9.3		11.1	9		115
120	7.1	7.4	6.9	10.8	9.1	7.6	11.3	9.1	7.6	11.4	9.1		11.2	9		10.8	8.7		120
125	6.7	7.1	6.7	10.2	8.8	7.4	10.8	8.9	7.4	11	8.8	7.4	10.9	8.7		10.5	8.5		125
130	6.4	6.8	6.5	9.7	8.5	7.2	10.3	8.6	7.2	10.6	8.6	7.2	10.5	8.5	7.2	10.2	8.3		130
135	6.1	6.6	6.4	9.2	8.2	7.1	9.8	8.3	7.1	10.2	8.3	7.1	10.2	8.3	7	9.9	8	6.9	135
140	5.8	6.3	6.2	8.7	7.9	6.9	9.3	8.1	6.9	9.8	8.1	6.9	9.9	8	6.9	9.6	7.8	6.8	140
145	5.5	6.1	6.2	8.3	7.6	6.8	8.9	7.8	6.8	9.4	7.9	6.8	9.5	7.8	6.8	9.3	7.7	6.7	145
150	5.3	6	6.2	7.9	7.4	6.6	8.5	7.6	6.7	8.9	7.6	6.7	9.2	7.6	6.7	9.1	7.5	6.6	150
155	5.1	5.9		7.6	7.2	6.5	8.1	7.4	6.6	8.6	7.4	6.6	8.8	7.4	6.6	8.8	7.3	6.5	155
160				7.2	7	6.4	7.7	7.2	6.5	8.2	7.3	6.5	8.5	7.3	6.5	8.5	7.2	6.4	160
165				6.9	6.8	6.3	7.4	7	6.4	7.9	7.1	6.4	8.2	7.1	6.4	8.3	7	6.3	165
170				6.7	6.7	6.3	7.2	6.8	6.3	7.6	6.9	6.3	7.9	7	6.3	8	6.9	6.2	170
175				6.4	6.5	6.2	6.9	6.7	6.2	7.3	6.8	6.2	7.6	6.8	6.2	7.7	6.8	6.2	175
180				6.2	6.4	6.2	6.7	6.5	6.2	7	6.6	6.2	7.3	6.7	6.2	7.5	6.6	6.1	180
185				6	6.2		6.4	6.4	6.2	6.8	6.5	6.1	7.1	6.5	6.1	7.3	6.5	6.1	185
190				5.8	6.1		6.2	6.3	6.2	6.6	6.3	6.1	6.9	6.4	6.1	7.1	6.4	6	190
195				5.6	6		6	6.1		6.4	6.2	6.1	6.6	6.3	6	6.8	6.3	6	195
200				5.4	6		5.8	6.1		6.2	6.1	6.1	6.4	6.2	6	6.6	6.2	5.9	200
205				5.3	5.9		5.6	6		6	6	6.1	6.3	6.1	6	6.5	6.1	5.9	205
210				5.1			5.5	5.9		5.8	6	6.1	6.1	6	6	6.3	6	5.9	210
215				5			5.3	5.9		5.6	5.9		5.9	5.9	6	6.1	5.9	5.9	215
220							5.2			5.5	5.8		5.8	5.8	6	6	5.9	5.9	220
225							5.1			5.4	5.8		5.6	5.8	6	5.8	5.8	5.9	225
230										5.2	5.8		5.5	5.7		5.7	5.7	5.9	230
235										5.1			5.3	5.7		5.6	5.7	5.9	235
240										5			5.2	5.7		5.4	5.6		240
245													5.1	5.7		5.3	5.6		245
250													5			5.2	5.6		250
255													4.8			5.1	5.6		255
260																5	5.6		260
265																4.8			265
270																2.8			270

\* adapter - pièce d'adaptateur

t\_259\_104\_18151 / 38151\_00\_000

# Lifting capacities Forces de levage

TNZF



↙	170 ft + 3.3 ft*			180 ft + 3.3 ft*			184 ft + 3.3 ft*			194 ft + 3.3 ft*			197 ft + 3.3 ft*			↘
	0°	22,5°	45°	0°	22,5°	45°	0°	22,5°	45°	0°	22,5°	45°	0°	22,5°	45°	
60	13.6															60
65	13.3			11.3			11.5			10.3						65
70	13			11.1			11.3			10.2			10			70
75	12.7			10.9			11			10			9.8			75
80	12.4			10.7			10.8			9.9			9.7			80
85	12.1			10.4			10.6			9.7			9.5			85
90	11.8			10.2			10.4			9.5			9.4			90
95	11.5			10			10.2			9.4			9.2			95
100	11.2			9.8			10			9.2			9			100
105	10.9			9.6			9.8			9			8.9			105
110	10.6	8.8		9.4			9.6			8.8			8.7			110
115	10.4	8.5		9.2	7.7		9.3	7.9		8.7			8.5			115
120	10.1	8.3		9	7.5		9.1	7.7		8.5	7.4		8.4	7.4		120
125	9.8	8.1		8.8	7.3		8.9	7.5		8.3	7.2		8.2	7.2		125
130	9.6	7.9		8.6	7.1		8.7	7.3		8.2	7		8.1	7		130
135	9.3	7.7		8.4	6.9		8.5	7.1		8	6.9		7.9	6.9		135
140	9.1	7.5	6.7	8.2	6.8		8.3	7		7.9	6.7		7.8	6.7		140
145	8.9	7.4	6.6	8.1	6.6	5.6	8.2	6.8	5.8	7.7	6.6		7.6	6.5		145
150	8.6	7.3	6.5	7.9	6.4	5.5	8	6.7	5.7	7.6	6.4	5.5	7.5	6.4	5.5	150
155	8.4	7.1	6.4	7.7	6.3	5.5	7.8	6.5	5.6	7.4	6.3	5.4	7.4	6.3	5.4	155
160	8.2	7	6.3	7.5	6.2	5.4	7.7	6.4	5.5	7.3	6.1	5.3	7.2	6.1	5.3	160
165	8	6.9	6.2	7.3	6	5.3	7.5	6.2	5.4	7.2	6	5.3	7.1	6	5.2	165
170	7.8	6.8	6.1	7.1	5.9	5.2	7.3	6.1	5.4	7	5.9	5.2	7	5.9	5.2	170
175	7.7	6.6	6.1	6.9	5.8	5.1	7.2	6	5.3	6.9	5.8	5.1	6.9	5.8	5.1	175
180	7.5	6.5	6	6.8	5.6	5.1	7	5.8	5.2	6.8	5.6	5.1	6.7	5.6	5.1	180
185	7.3	6.4	6	6.6	5.5	5	6.8	5.7	5.2	6.6	5.5	5	6.6	5.5	5	185
190	7.1	6.3	5.9	6.4	5.4	5	6.7	5.6	5.1	6.5	5.4	5	6.5	5.4	4.9	190
195	6.9	6.2	5.9	6.3	5.3	4.9	6.5	5.5	5	6.3	5.4	4.9	6.3	5.4	4.9	195
200	6.8	6.1	5.9	6.1	5.2	4.9	6.4	5.4	5	6.2	5.3	4.9	6.2	5.3	4.9	200
205	6.6	6	5.9	6	5.1	4.8	6.2	5.3	5	6.1	5.2	4.8	6.1	5.2	4.8	205
210	6.4	5.9	5.8	5.8	5.1	4.8	6.1	5.3	4.9	5.9	5.1	4.8	5.9	5.1	4.8	210
215	6.2	5.9	5.8	5.7	5	4.8	5.9	5.2	4.9	5.8	5	4.8	5.8	5	4.8	215
220	6.1	5.8	5.8	5.6	4.9	4.8	5.8	5.1	4.9	5.7	4.9	4.8	5.7	4.9	4.7	220
225	6	5.7	5.8	5.5	4.8	4.8	5.7	5	4.9	5.6	4.9	4.7	5.6	4.9	4.7	225
230	5.8	5.7	5.8	5.4	4.8	4.8	5.6	4.9	4.9	5.4	4.8	4.7	5.4	4.8	4.7	230
235	5.7	5.6	5.8	5.3	4.7	4.8	5.5	4.9	4.9	5.3	4.7	4.7	5.3	4.7	4.7	235
240	5.6	5.6	5.8	5.1	4.7	4.8	5.4	4.8	4.9	5.2	4.7	4.7	5.2	4.7	4.7	240
245	5.4	5.5	5.8	5	4.6	4.8	5.2	4.8	4.9	5.1	4.6	4.7	5.1	4.7	4.7	245
250	5.3	5.5		4.9	4.6	4.8	5.2	4.8	4.9	5	4.6	4.7	5	4.6	4.7	250
255	5.2	5.5		4.7	4.6	4.8	5.1	4.7	4.9	4.9	4.6	4.7	4.9	4.6	4.7	255
260	5.2	5.5		4.6	4.6		5	4.7	4.9	4.8	4.5	4.7	4.8	4.6	4.7	260
265	5	5.5		4.4	4.6		4.9	4.7		4.7	4.5	4.7	4.6	4.5	4.7	265
270	4.8	5.1		4.3	4.5		4.7	4.7		4.5	4.5	4.7	4.3	4.5	4.7	270
275	4.5			4.2	4.3		4.3	4.7		4.1	4.4		3.9	4.5		275
280	3			4	4.2		4	4.6		3.8	4.4		3.6	4.3		280
285				3.5			3.4	4.1		3.4	4.1		3.3	4		285
290										3.1	3.7		2.9	3.5		290
295										2.4	3.2		2.5	3.1		295

\* adapter - pièce d'adaptateur

t\_259\_104\_18151 / 38151\_00\_000

# Lifting capacities Forces de levage

TNZF



Lifting height (ft)	43 ft + 3.3 ft*			99 ft + 3.3 ft*			114 ft + 3.3 ft*			128 ft + 3.3 ft*			142 ft + 3.3 ft*			156 ft + 3.3 ft*			Lifting height (ft)
	0°	22.5°	45°	0°	22.5°	45°	0°	22.5°	45°	0°	22.5°	45°	0°	22.5°	45°	0°	22.5°	45°	
30	17.4																		30
32	17.3																		32
34	17																		34
36	16.7																		36
38	16.4																		38
40	16																		40
45	15.2			17			16.3												45
50	14.4			16.3			15.8			14.9									50
55	13.6			15.7			15.2			14.4			13.4						55
60	12.8			15.1			14.7			14			13			11.8			60
65	12			14.4			14.1			13.5			12.6			11.5			65
70	11.3			13.8			13.6			13			12.2			11.2			70
75	10.7			13.2			13			12.6			11.8			10.9			75
80	10.1			12.6			12.5			12.1			11.5			10.6			80
85	9.5	8.5		12			12			11.6			11.1			10.3			85
90	8.8	8.1		11.5			11.5			11.2			10.7			9.9			90
95	8.2	7.6		11			11			10.8			10.3			9.6			95
100	7.6	7.3		10.5	8.2		10.6	8.2		10.4			10			9.3			100
105	7.2	6.9		10	7.9		10.1	7.9		10	7.7		9.6			9			105
110	6.7	6.6		9.6	7.6		9.7	7.6		9.6	7.5		9.3	7.3		8.8			110
115	6.3	6.3		9.1	7.3		9.3	7.3		9.2	7.2		8.9	7.1		8.5	6.8		115
120	5.9	6		8.6	7.1		8.9	7.1		8.9	7		8.6	6.9		8.2	6.6		120
125	5.6	5.7	5.3	8.1	6.8		8.5	6.8		8.5	6.8		8.4	6.7		7.9	6.4		125
130	5.3	5.5	5.1	7.7	6.6		8.1	6.6		8.2	6.6		8.1	6.5		7.7	6.3		130
135	5	5.2	4.9	7.3	6.3		7.7	6.4		7.9	6.4		7.8	6.3		7.5	6.1		135
140	4.7	5	4.7	7	6.1	5.2	7.3	6.2	5.2	7.6	6.2		7.5	6.1		7.3	6		140
145	4.4	4.8	4.5	6.6	5.9	5	7	6	5	7.3	6	5	7.3	5.9		7.1	5.8		145
150	4.2	4.6	4.4	6.3	5.7	4.9	6.7	5.8	4.9	7	5.8	4.9	7.1	5.8	4.9	6.9	5.7		150
155	4	4.4	4.3	6	5.5	4.8	6.4	5.6	4.8	6.7	5.7	4.8	6.8	5.6	4.7	6.7	5.5	4.7	155
160	3.8	4.2	4.2	5.7	5.3	4.7	6.1	5.5	4.7	6.4	5.5	4.7	6.6	5.5	4.7	6.5	5.4	4.6	160
165	3.6	4.1	4.1	5.5	5.2	4.6	5.9	5.3	4.6	6.1	5.4	4.6	6.3	5.3	4.6	6.3	5.3	4.5	165
170	3.4	4	4.1	5.2	5	4.5	5.6	5.1	4.5	5.9	5.2	4.5	6.1	5.2	4.5	6.2	5.1	4.4	170
175	3.3	3.9		5	4.9	4.4	5.4	5	4.4	5.7	5.1	4.4	5.9	5.1	4.4	6	5	4.3	175
180	3.1	3.9		4.8	4.7	4.3	5.2	4.8	4.3	5.5	4.9	4.3	5.7	4.9	4.3	5.8	4.9	4.2	180
185				4.6	4.6	4.2	5	4.7	4.3	5.2	4.8	4.2	5.5	4.8	4.2	5.6	4.8	4.2	185
190				4.4	4.5	4.1	4.8	4.6	4.2	5	4.7	4.2	5.2	4.7	4.2	5.4	4.6	4.1	190
195				4.2	4.3	4.1	4.6	4.5	4.1	4.9	4.5	4.1	5.1	4.6	4.1	5.2	4.5	4.1	195
200				4.1	4.2	4.1	4.4	4.3	4.1	4.7	4.4	4.1	4.9	4.4	4.1	5	4.4	4	200
205				3.9	4.1	4.1	4.2	4.2	4	4.5	4.3	4	4.7	4.3	4	4.9	4.3	4	205
210				3.7	4		4.1	4.1	4	4.3	4.2	4	4.6	4.2	4	4.7	4.2	3.9	210
215				3.6	4		3.9	4.1	4	4.2	4.1	4	4.4	4.2	3.9	4.5	4.1	3.9	215
220				3.5	3.9		3.8	4		4	4	4	4.3	4.1	3.9	4.4	4.1	3.9	220
225				3.3	3.9		3.6	3.9		3.9	4	4	4.1	4	3.9	4.3	4	3.9	225
230				3.2			3.5	3.9		3.8	3.9	4	4	3.9	3.9	4.1	3.9	3.8	230
235				3.2			3.4	3.8		3.6	3.9		3.8	3.9	3.9	4	3.9	3.8	235
240							3.3	3.8		3.5	3.8		3.7	3.8	3.9	3.9	3.8	3.8	240
245							3.2			3.4	3.8		3.6	3.8	3.9	3.8	3.7	3.8	245
250							3.1			3.3	3.7		3.5	3.7		3.7	3.7	3.8	250
255										3.2	3.7		3.4	3.7		3.6	3.7	3.8	255
260										3.2			3.3	3.7		3.5	3.6		260
265										3.1			3.2	3.7		3.4	3.6		265
270													3.2			3.3	3.6		270
275													3.1			3.2	3.6		275
280																3.1	3.6		280
285																3.1			285
290																2.6			290

\* adapter - pièce d'adaptateur

t\_259\_104\_22151 / 42151\_00\_000

# Lifting capacities Forces de levage

TNZF



↙	170 ft + 3.3 ft*			180 ft + 3.3 ft*			184 ft + 3.3 ft*			194 ft + 3.3 ft*			197 ft + 3.3 ft*			↘
	0°	22,5°	45°	0°	22,5°	45°	0°	22,5°	45°	0°	22,5°	45°	0°	22,5°	45°	
65	10.1															65
70	9.9			8.3			8.4									70
75	9.7			8.1			8.2			7.4			7.3			75
80	9.4			7.9			8.1			7.3			7.2			80
85	9.2			7.8			7.9			7.2			7.1			85
90	8.9			7.6			7.7			7.1			7			90
95	8.7			7.4			7.6			6.9			6.8			95
100	8.5			7.3			7.4			6.8			6.7			100
105	8.2			7.2			7.3			6.7			6.6			105
110	8			7			7.1			6.6			6.5			110
115	7.8			6.9			7			6.5			6.4			115
120	7.6			6.7			6.8			6.4			6.3			120
125	7.4	6.1		6.6			6.7			6.2			6.1			125
130	7.2	6		6.4	5.5		6.5	5.6		6.1			6			130
135	7	5.9		6.3	5.4		6.4	5.5		6	5.2		5.9	5.2		135
140	6.8	5.7		6.2	5.2		6.3	5.4		5.9	5.1		5.8	5.1		140
145	6.7	5.6		6.1	5.1		6.1	5.2		5.8	5		5.7	5		145
150	6.5	5.4		5.9	4.9		6	5.1		5.7	4.9		5.6	4.9		150
155	6.3	5.3		5.8	4.8		5.9	5		5.5	4.8		5.5	4.8		155
160	6.2	5.2	4.5	5.7	4.7		5.7	4.8		5.4	4.7		5.4	4.6		160
165	6.1	5.1	4.4	5.5	4.5	3.8	5.6	4.7	3.9	5.3	4.5		5.3	4.5		165
170	5.9	5	4.3	5.4	4.4	3.7	5.5	4.6	3.8	5.2	4.4	3.7	5.2	4.4	3.6	170
175	5.8	4.9	4.2	5.3	4.3	3.6	5.4	4.5	3.7	5.1	4.3	3.6	5.1	4.3	3.6	175
180	5.6	4.7	4.2	5.2	4.2	3.5	5.3	4.4	3.7	5	4.2	3.5	5	4.2	3.5	180
185	5.5	4.6	4.1	5.1	4.1	3.5	5.2	4.3	3.6	5	4.1	3.5	4.9	4.1	3.5	185
190	5.3	4.5	4.1	4.9	4	3.4	5.1	4.1	3.5	4.9	4	3.4	4.8	4	3.4	190
195	5.2	4.4	4	4.8	3.9	3.4	5	4.1	3.5	4.8	3.9	3.3	4.7	3.9	3.4	195
200	5	4.3	4	4.7	3.8	3.3	4.8	4	3.4	4.7	3.8	3.3	4.6	3.8	3.3	200
205	4.9	4.3	3.9	4.6	3.7	3.2	4.7	3.9	3.4	4.6	3.7	3.2	4.5	3.7	3.2	205
210	4.8	4.2	3.9	4.4	3.6	3.2	4.6	3.8	3.3	4.5	3.6	3.2	4.4	3.6	3.2	210
215	4.6	4.1	3.8	4.3	3.5	3.2	4.5	3.7	3.3	4.4	3.6	3.2	4.4	3.6	3.2	215
220	4.5	4	3.8	4.2	3.5	3.1	4.4	3.6	3.3	4.3	3.5	3.1	4.2	3.5	3.1	220
225	4.3	3.9	3.8	4.1	3.4	3.1	4.3	3.5	3.2	4.1	3.4	3.1	4.1	3.4	3.1	225
230	4.2	3.9	3.8	4	3.3	3.1	4.2	3.5	3.2	4	3.4	3.1	4	3.3	3.1	230
235	4.1	3.8	3.8	3.9	3.3	3.1	4	3.4	3.2	3.9	3.3	3	3.9	3.3	3	235
240	4	3.7	3.8	3.8	3.2	3	3.9	3.3	3.2	3.8	3.2	3	3.8	3.2	3	240
245	3.9	3.7	3.8	3.7	3.1	3	3.9	3.3	3.1	3.7	3.2	3	3.7	3.2	3	245
250	3.8	3.6	3.8	3.6	3.1	3	3.8	3.2	3.1	3.7	3.1	3	3.7	3.1	3	250
255	3.7	3.6	3.8	3.5	3	3	3.7	3.2	3.1	3.6	3.1	3	3.6	3.1	3	255
260	3.6	3.6	3.8	3.4	3	3	3.6	3.1	3.1	3.5	3	3	3.5	3	3	260
265	3.5	3.5	3.8	3.3	3	3	3.5	3.1	3.1	3.4	3	3	3.4	3	3	265
270	3.4	3.5		3.3	2.9	3	3.4	3.1	3.1	3.3	2.9	3	3.3	2.9	3	270
275	3.3	3.5		3.2	2.9		3.4	3	3.1	3.2	2.9	3	3.3	2.9	3	275
280	3.2	3.5		3.1	2.9		3.3	3		3.1	2.9	3	3.2	2.9	3	280
285	3.2	3.5		2.9	2.9		3.2	3		3	2.9	3	2.9	2.9	3	285
290	3.1	3.5		2.8	2.9		3	3		2.8	2.9		2.6	2.8		290
295	3			2.7	2.9		2.8	3		2.5	2.9		2.3	2.8		295
300				2.5	2.8		2.4	3			2.8			2.8		300
305				2.3				2.7			2.7			2.5		305
310											2.3					310

\* adapter - pièce d'adaptateur

t\_259\_104\_22151 / 42151\_00\_000

# Lifting capacities Forces de levage

TNZF



Lifting height (ft)	43 ft + 3.3 ft*			99 ft + 3.3 ft*			114 ft + 3.3 ft*			128 ft + 3.3 ft*			142 ft + 3.3 ft*			156 ft + 3.3 ft*			Lifting height (ft)
	0°	22.5°	45°	0°	22.5°	45°	0°	22.5°	45°	0°	22.5°	45°	0°	22.5°	45°	0°	22.5°	45°	
34	12.5																		34
36	12.5																		36
38	12.3																		38
40	12.1																		40
45	11.6																		45
50	11.1			12.1			11.7												50
55	10.6			11.8			11.3			10.7									55
60	10			11.4			11			10.4			9.6						60
65	9.5			11			10.7			10.1			9.4			8.5			65
70	9			10.6			10.3			9.8			9.1			8.3			70
75	8.5			10.1			9.9			9.5			8.8			8			75
80	8.1			9.7			9.5			9.1			8.6			7.8			80
85	7.6			9.3			9.2			8.8			8.3			7.6			85
90	7.2			8.9			8.8			8.5			8			7.4			90
95	6.9			8.6			8.5			8.2			7.8			7.2			95
100	6.5	6		8.2			8.1			7.9			7.5			7			100
105	6.1	5.7		7.8			7.8			7.6			7.3			6.8			105
110	5.7	5.4		7.5			7.5			7.3			7.1			6.6			110
115	5.3	5.2		7.2	5.8		7.2	5.8		7.1			6.8			6.5			115
120	5	4.9		6.9	5.6		6.9	5.6		6.8	5.5		6.6			6.3			120
125	4.6	4.6		6.6	5.4		6.7	5.4		6.6	5.3		6.4	5.1		6.1			125
130	4.3	4.4		6.3	5.2		6.4	5.2		6.4	5.1		6.2	5		5.9	4.8		130
135	4.1	4.2		6	5		6.2	5		6.2	5		6	4.8		5.7	4.6		135
140	3.8	4		5.7	4.8		5.9	4.8		5.9	4.8		5.8	4.7		5.6	4.5		140
145	3.6	3.8	3.5	5.4	4.6		5.6	4.6		5.7	4.6		5.6	4.5		5.4	4.4		145
150	3.4	3.6	3.3	5.1	4.4		5.4	4.5		5.5	4.5		5.5	4.4		5.2	4.2		150
155	3.1	3.4	3.2	4.8	4.3		5.2	4.3		5.3	4.3		5.3	4.3		5.1	4.1		155
160	2.9	3.2	3	4.6	4.1	3.4	4.9	4.1	3.4	5.1	4.2		5.1	4.1		4.9	4		160
165	2.8	3.1	2.9	4.4	3.9	3.3	4.7	4	3.3	4.9	4	3.3	4.9	4		4.8	3.9		165
170	2.6	2.9	2.8	4.2	3.8	3.2	4.4	3.8	3.2	4.7	3.9	3.2	4.8	3.9	3.1	4.6	3.8		170
175	2.4	2.8	2.7	4	3.6	3.1	4.2	3.7	3.1	4.5	3.7	3.1	4.6	3.7	3.1	4.5	3.7	3	175
180	2.3	2.7	2.6	3.8	3.5	3	4	3.6	3	4.2	3.6	3	4.4	3.6	3	4.3	3.5	2.9	180
185	2.2	2.5	2.5	3.6	3.4	2.9	3.8	3.5	2.9	4	3.5	2.9	4.2	3.5	2.9	4.2	3.4	2.8	185
190		2.4	2.5	3.4	3.3	2.8	3.7	3.3	2.9	3.9	3.4	2.9	4	3.4	2.8	4	3.3	2.8	190
195		2.3	2.5	3.2	3.1	2.8	3.5	3.2	2.8	3.7	3.3	2.8	3.8	3.3	2.7	3.9	3.2	2.7	195
200		2.3		3.1	3	2.7	3.3	3.1	2.7	3.5	3.2	2.7	3.7	3.2	2.7	3.7	3.1	2.6	200
205				2.9	2.9	2.6	3.2	3	2.6	3.4	3.1	2.6	3.5	3.1	2.6	3.5	3	2.6	205
210				2.8	2.8	2.6	3	2.9	2.6	3.2	3	2.6	3.4	3	2.6	3.4	2.9	2.5	210
215				2.6	2.7	2.5	2.9	2.8	2.6	3.1	2.9	2.5	3.2	2.9	2.5	3.3	2.8	2.5	215
220				2.5	2.6	2.5	2.7	2.7	2.5	3	2.8	2.5	3.1	2.8	2.5	3.1	2.8	2.4	220
225				2.4	2.5	2.5	2.6	2.6	2.5	2.8	2.7	2.5	2.9	2.7	2.4	3	2.7	2.4	225
230				2.2	2.5	2.5	2.5	2.6	2.5	2.7	2.6	2.4	2.8	2.6	2.4	2.9	2.6	2.4	230
235				2.1	2.4		2.4	2.5	2.5	2.6	2.5	2.4	2.7	2.6	2.4	2.7	2.5	2.3	235
240					2.4		2.3	2.4		2.5	2.5	2.4	2.6	2.5	2.4	2.6	2.5	2.3	240
245					2.3		2.2	2.4		2.3	2.4	2.4	2.5	2.4	2.4	2.5	2.4	2.3	245
250					2.3			2.3		2.2	2.3		2.4	2.4	2.3	2.4	2.4	2.3	250
255								2.3		2.1	2.3		2.2	2.3	2.3	2.3	2.3	2.3	255
260								2.3			2.3		2.1	2.3	2.3	2.2	2.3	2.3	260
265											2.2			2.2		2.1	2.2	2.3	265
270											2.2			2.2			2.2	2.3	270
275											2.2			2.2			2.1	2.3	275
280														2.2			2.1		280
285																	2.1		285

\* adapter - pièce d'adaptateur

t\_259\_104\_24151 / 44151\_00\_000

# Lifting capacities Forces de levage

TNZF



↙ ↘	170 ft			180 ft			184 ft			194 ft		↙ ↘
	0°	22,5°	45°	164 ft			0°	22,5°	45°	0°	22,5°	
70	7.3											70
75	7.1			6			6.1					75
80	7			5.9			6			5.4		80
85	6.8			5.8			5.9			5.3		85
90	6.7			5.7			5.8			5.2		90
95	6.5			5.6			5.7			5.1		95
100	6.4			5.5			5.6			5.1		100
105	6.2			5.4			5.4			5		105
110	6.1			5.2			5.3			4.9		110
115	5.9			5.1			5.2			4.8		115
120	5.8			5			5.1			4.7		120
125	5.6			4.9			5			4.6		125
130	5.5			4.8			4.9			4.5		130
135	5.3			4.7			4.8			4.4		135
140	5.2	4.3		4.6			4.7			4.3		140
145	5	4.1		4.5	3.8		4.5	3.8		4.2		145
150	4.9	4		4.4	3.7		4.4	3.7		4.1		150
155	4.8	3.9		4.2	3.6		4.3	3.6		4	3.4	155
160	4.6	3.8		4.1	3.4		4.2	3.5		3.9	3.3	160
165	4.5	3.7		4	3.3		4.1	3.4		3.8	3.2	165
170	4.4	3.6		4	3.2		4	3.3		3.7	3.1	170
175	4.3	3.5		3.9	3.1		3.9	3.2		3.7	3	175
180	4.1	3.4	2.8	3.8	3		3.8	3.1		3.6	2.9	180
185	4	3.3	2.8	3.7	2.9		3.7	3		3.5	2.8	185
190	3.9	3.2	2.7	3.5	2.8	2.3	3.6	2.9	2.4	3.4	2.7	190
195	3.8	3.1	2.6	3.4	2.7	2.2	3.5	2.8	2.3	3.3	2.6	195
200	3.6	3	2.6	3.3	2.6	2.2	3.4	2.7	2.3	3.2	2.5	200
205	3.5	2.9	2.5	3.2	2.5	2.1	3.3	2.7	2.2	3.1	2.5	205
210	3.4	2.9	2.5	3.1	2.4		3.2	2.6	2.1	3.1	2.4	210
215	3.3	2.8	2.4	3	2.3		3.1	2.5		3	2.3	215
220	3.1	2.7	2.4	2.9	2.3		3	2.4		2.9	2.2	220
225	3	2.6	2.4	2.8	2.2		2.9	2.3		2.8	2.2	225
230	2.9	2.6	2.3	2.7	2.1		2.8	2.3		2.7		230
235	2.8	2.5	2.3	2.6			2.7	2.2		2.6		235
240	2.6	2.4	2.3	2.5			2.6	2.1		2.5		240
245	2.5	2.4	2.2	2.4			2.5			2.4		245
250	2.4	2.3	2.2	2.3			2.4			2.3		250
255	2.3	2.3	2.2	2.2			2.3			2.3		255
260	2.3	2.2	2.2	2.2			2.2			2.2		260
265	2.2	2.2	2.2				2.2			2.1		265
270		2.1	2.2									270
275		2.1	2.2									275
280			2.2									280
285			2.2									285

\* adapter - pièce d'adaptateur

t\_259\_104\_24151 / 44151\_00\_000

# Lifting heights Hauteurs de levage

**TNZF**

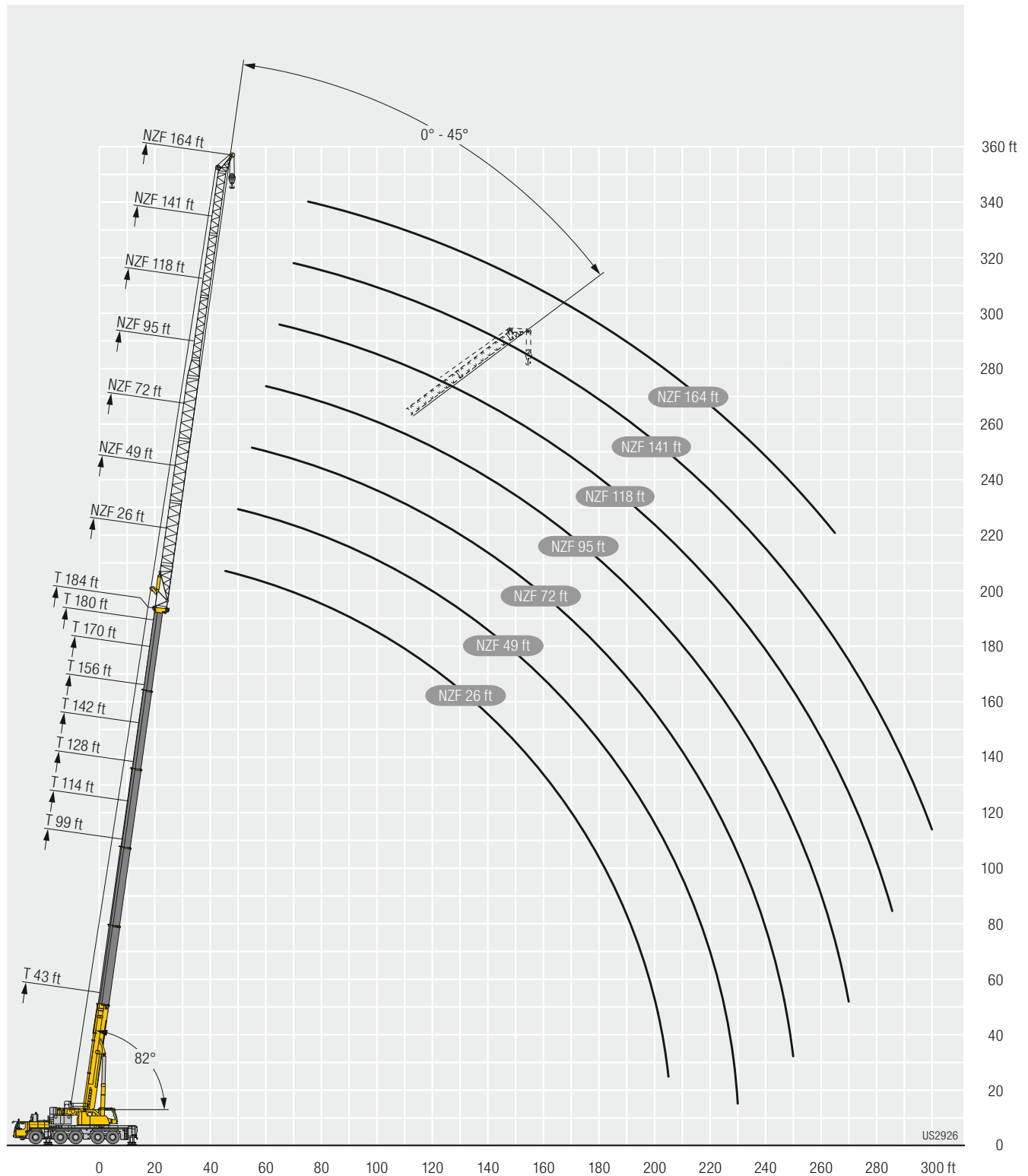



# Equipment Equipment

## Crane carrier

<b>Frame</b>	Self-manufactured, torsion-resistant box-type design of high-tensile fine grained structural steel.
<b>Outriggers</b>	4-point supporting system, hydraulically telescopic into horizontal and vertical direction. Operation with remote control, automatic support leveling, electronic inclination display.
<b>Engine</b>	6-cylinder Diesel, make Liebherr, watercooled, output 400 kW (544 h.p.), max. torque 1856 lb-ft. Exhaust emissions acc. to (EU) 2016/1628, EPA/CARB or ECE-R.96. Fuel reservoir: 198 gallons.
<b>Transmission</b>	ZF 12-speed gear box with automatic control system. ZF-intarder fitted directly to the gear. Two-stage transfer case with lockable transfer differential.
<b>Axles</b>	Low maintenance carrier axles, all 5 axles steered. Axle 2, 4 and 5 are equipped with planetary gears, all driven axles with transverse differential locks, axle 4 with longitudinal differential lock.
<b>Suspension</b>	All axles are mounted on hydropneumatic suspension – “Niveaumatik suspension” and are lockable hydraulically.
<b>Tyres</b>	10 tyres. Size of tyres: 445/95 R 25 (16.00 R 25).
<b>Steering</b>	2-circuit system with hydraulic servo steering. Active speed depending rear axle steering, special steering programs for various driving situations.
<b>Brakes</b>	Service brake: all-wheel servo-air brake, all axles are equipped with disc brakes, dual circuit. Additional brakes: exhaust flap brake, Telma Eddy current brake (optional), intarder in gearbox. Hand brake: Spring-loaded, acting on all wheels of axles 2 to 5.
<b>Driver's cab</b>	Spacious corrosion resistant with comfort furnishings, mounted on rubber shock absorbers, safety glazing.
<b>Electrical system</b>	Modern data bus technique, 24 Volt DC, 2 batteries of 170 Ah each.

## Crane superstructure

<b>Frame</b>	Liebherr-manufactured, torsionally rigid steel construction made from high-tensile fine-grain steel. Triple-roller slewing rim.
<b>Crane drive</b>	Mechanical drive of the crane hydraulic from the chassis. Variable axial piston pumps with servo control and power regulation.
<b>Control</b>	Electric „Load Sensing“ control, simultaneous operation of 4 working motions, 2 self-centering hand control levers (joy-stick type).
<b>Hoist gear</b>	Axial piston fixed displacement motor, Liebherr hoist drum with integrated planetary gear and spring-loaded static brake.
<b>Luffing gear</b>	1 differential ram with pilot-controlled brake valve.
<b>Slewing gear</b>	Axial piston fixed displacement motor, planetary gear, spring-loaded static brake. Slewing gear inversible from released to locked as standard feature.
<b>Crane cab</b>	Large screen area, compound glass, comfort furnishing, cabin tilttable 20° to rear.
<b>Safety devices</b>	LICCON2 safe load indicator, test system, hoist limit switches, safety valves against rupture of pipes and hoses.
<b>Telescopic boom</b>	1 base section and 5 telescopic sections. All telescopic sections extendable individually by means of the rapid-cycle telescoping system TELEMATIK. Boom length 43 ft to 197 ft.
<b>Counterweight</b>	149,900 lb

The pictures contain also accessories and special equipment not included in the standard scope of delivery.

## Additional equipment

<b>K</b>	Swing away jib 18 ft, 40 ft – 72 ft, 95 ft, 118 ft Adjustment 0°; 22,5°; 45°
<b>NZK</b>	Hydraulically adjustable swing-away jib 18 ft, 40 ft – 72 ft, 95 ft, 118 ft Hydraulically adjustment 0° – 45°
<b>V</b>	Telescopic boom extension 2 x 23 ft
<b>NZF</b>	Fixed lattice jib 26 ft – 164 ft Hydraulic adjustment 0° – 45°
<b>S</b>	Powerful jib 13 ft – 151 ft, 0°
<b>2<sup>nd</sup> hoist gear</b>	For two-hook operation.
<b>Tyres</b>	10 tyres, size and 525/80 R 25 (20.5 R 25).
<b>Drive 10 x 8</b>	Additional drive of the 3 <sup>rd</sup> axle.
<b>Additional counterweight</b>	44,100 lb for a total counterweight of 194,000 lb.

Other items of equipment available on request.

# Equipment Équipement

## Châssis porteur

<b>Cadre</b>	Châssis résistant à la torsion de fabrication Liebherr, en acier à grains fins très résistant.
<b>Calage</b>	Dispositif de calage horizontal et vertical en 4 points, entièrement déployable hydrauliquement. Utilisation avec commande à distance, mise à niveau automatique du calage, inclinomètre électronique.
<b>Moteur</b>	Moteur diesel, 6 cylindres, fabrique par Liebherr, a refroidissement par eau, de 400 kW (544 ch), couple max. 1856 lb-ft. Emissions des gaz d'échappement conformes au directive (EU) 2016/1628, EPA/CARB ou ECE-R.96. Capacité du réservoir à carburant : 198 gallons.
<b>Boîte de vitesse</b>	Boîte de vitesses ZF à 12 rapports, mécanisme automatisé à commande. Ralentisseur hydrodynamique ZF directement accouplé à la boîte. Boîte de transfert à 2 étages avec blocage de différentiel.
<b>Essieux</b>	Essieux nécessitant peu d'entretien, les 5 essieux sont directeurs. Les essieux 2, 4 et 5 sont des essieux planétaires, tous les essieux moteurs avec différentiel transversal et l'essieu 4 avec différentiel longitudinal.
<b>Suspension</b>	Suspension hydropneumatique «Niveumatik» – sur tous les essieux. Chaque essieu peut être bloqué hydrauliquement.
<b>Pneumatiques</b>	10 pneus. Taille: 445/95 R 25 (16.00 R 25).
<b>Direction</b>	2 circuits avec direction assistée hydraulique. Direction active des essieux arrière et dépendante de la vitesse, programmes de direction spéciaux pour les différents modes de déplacement.
<b>Freins</b>	Freins de service : servofrein à air comprimé, tous les essieux sont munis de freins à disque, à 2 circuits. Freins auxiliaire : par clapet sur échappement, frein Telma (option), ralentisseur monté sur boîte de vitesse. Frein de secours et frein à main : par cylindres à ressorts sur les essieux 2 à 5.
<b>Cabine</b>	Spacieuse cabine, traitement anticorrosion, équipement «grand confort», suspension par silentbloks, vitrage de sécurité.
<b>Installation électrique</b>	Technique moderne de transmission de données par BUS de données, courant continu 24 Volts, 2 batteries de 170 Ah chacune.

## Partie tournante

<b>Cadre</b>	Fabrication Liebherr, construction soudée indéformable, en acier à grain fin haute résistance. Couronne d'orientation à triple rangée de rouleaux.
<b>Entraînement</b>	Entraînement mécanique de l'hydraulique de la grue par le châssis de la grue. Pompes réglables à pistons axiaux avec servocommande et réglage de puissance.
<b>Commande</b>	Direction électrique "Load Sensing", 4 mouvements de travail dirigeable simultanément, deux leviers de commande à 4 positions et à autocentrage.
<b>Mécanisme de levage</b>	Moteur à cylindrée constante et à pistons axiaux. Treuil de marque Liebherr équipé d'un engrenage planétaire et d'un frein d'arrêt commandé par ressort.
<b>Mécanisme de relevage</b>	1 vérin différentiel avec clapet de frein commandé.
<b>Dispositif de rotation</b>	Moteur à cylindrée constante à pistons axiaux, réducteur planétaire, frein d'arrêt commandé par ressort. Commutation en série du mécanisme d'orientation: ouvert et en orientation freinée automatiquement.

<b>Cabine de grue</b>	Large champ de vision, vitrage de sécurité, équipement pour un confort idéal, cabine inclinable de 20° vers l'arrière.
<b>Dispositif de sécurité</b>	Contrôleur de charge LICCON2, système test, fin de course crochet haut, clapets de sécurité en cas de ruptures de flexibles.
<b>Flèche télescopique</b>	Un élément de base et de 5 télescopes. Chaque partie peut être télescopée individuellement à l'aide du système de télescopage séquentiel rapide TELEMATIK. Longueur de flèche: 43 ft – 197 ft.
<b>Contrepoids</b>	149,900 lb

## Équipement supplémentaire







































<b>K</b>	Flechette pliante 18 ft, 40 ft – 72 ft, 95 ft, 118 ft. Positionnement 0°; 22,5°; 45°
<b>NZK</b>	Flechette pliante a positionnement hydraulique 18 ft, 40 ft – 72 ft, 95 ft, 118 ft. Positionnement hydraulique à 0° – 45°
<b>V</b>	Rallonge flèche télescopique 2 x 23 ft
<b>NZF</b>	Flechette treillis fixe 26 ft – 164 ft Positionnement hydraulique à 0° – 45°
<b>S</b>	Flechette particulièrement puissante 13 ft – 151 ft, 0°
<b>2ème mécanisme de levage</b>	Pour l'utilisation du deuxième crochet.
<b>Pneumatiques</b>	10 pneus. Taille: 525/80 R 25 (20.5 R 25).
<b>Entraînement 10 x 8</b>	Essieu 3 est entraîné additionnellement.
<b>Contrepoids additionnel</b>	44,100 lb pour un contrepoids total de 194,000 lb.

### Autres équipements supplémentaires sur demande.

Les figures contiennent également des accessoires et des équipements spéciaux non inclus de série dans la livraison.

# Description of symbols

## Explication des symboles

	Max. capacity Capacité max.		Max. single line pull Effort au brin maxi.
	Max. lifting capacity Capacité max.		Hoist gear Treuil de levage
	Max. radius Portée max.		Slewing speeds Vitesses d'orientation
	Tyres Pneumatiques		Boom length Longueur de la flèche
	Hookblock / Capacity Moufle à crochet / Capacité de charge		Boom position Position de la flèche
	No. of sheaves Poulies		Counterweight Contrepoids
	No. of lines Brins		Counterweight radius Rayon de contrepoids
	Weight Poids		Axle Essieu
	Crane carrier Châssis porteur		Page Page
	Driving speed Vitesse de translation		Outriggers Calage
	Gradability Aptitude à graver les pentes		Slewing gear / Working area Mécanisme d'orientation / Plage de travail
	Transmission Boîte de vitesse		Standard Norme
	Gear Vitesse		Radius Portée
	Driving speed – Onroad gear Vitesse de translation – Vitesse de route		Telescopic boom Flèche télescopique
	Driving speed – Crawl speed Vitesse de translation – Marche lente		Swing away jib Fléchette pliante
	Crane superstructure Partie tournante de la grue		Hydraulic swing away jib Fléchette pliante hydraulique
	infinitely variable en continu		Telescopic boom extension Rallonge flèche télescopique
	Rope diameter Diamètre		Hydraulic lattice jib Fléchette treillis hydraulique
	Rope length Longueur du câble		Powerful jib Fléchette particulièrement puissante

## Remarks

1. The lifting capacities do not exceed 85 % of the tipping load according to ASME B 30.5. The crane's structural steelwork is in accordance with EN 13000 and ASME B 30.5.
2. For the calculation of the load charts at least a wind speed of 30 ft/s (9 m/s, 20 mph) and regarding the load a sail area of 1 m<sup>2</sup> per ton load and a wind resistance coefficient of 1.2 on the load have been taken into account. For lifting of loads with large sail areas and/or high wind resistance coefficients the maximum wind speed as stated in the load charts has to be reduced.
3. The lifting capacities stated are valid for lifting operation only (corresponding with crane classification according to ISO 4301-1, crane group A1).
4. Lifting capacities are given in kips.
5. The weight of the hook blocks and hooks must be deducted from the lifting capacities.
6. Working radii are measured from the slewing centre.
7. The stated lengths of the telescopic boom are maximum values and may deviate slightly.
8. The lifting capacities given for the telescopic boom apply if the folding jib is removed.
9. Subject to modification of lifting capacities.
10. Lifting capacities above 295,400 lb/332,900 lb only with additional pulley block/special equipment.
11. The data of this brochure serves only for general information. All information is provided without warranty. Instructions for the correct commissioning of the crane please take from the operation manual and the load chart book.

## Remarques

1. La capacité de charge ne doit pas dépasser 85 % de la charge de basculement conformément à ASME B 30.5. La structure métallique de la grue est conforme à EN 13000 et ASME B 30.5.
2. Une vitesse de vent de 30 ft/s (9 m/s, 20 mph) minimum, une surface de prise au vent de 1 m<sup>2</sup> par tonne ainsi qu'un coefficient de résistance au vent de la charge 1,2 sont pris en compte pour le calcul des tableaux de charge. Lorsque des charges ayant une surface de prise au vent et/ou un coefficient de résistance au vent plus élevé(e)s sont levées, la vitesse de vent maximale indiquée dans les tableaux de charge doit être réduite.
3. Forces de levage pour application de grue de montage (correspond à la classification de grues selon ISO 4301-1, groupe de grues A1).
4. Les forces de levage sont données en kips.
5. Les poids des mouffes et crochets doit être soustrait des charges indiquées.
6. Les portées sont calculées à partir de l'axe de rotation.
7. Les longueurs indiquées pour la flèche télescopique sont des valeurs maximales et peuvent légèrement varier dans la réalité.
8. Les charges indiquées pour la flèche télescopique sont valables lorsque la fléchette pliante est démontée.
9. Charges données sous réserve de modification.
10. Forces de levage plus de 295,400 lb/332,900 lb seulement avec moufle additionnel/équipement supplémentaire.
11. Les données de cette brochure sont données à titre informatif. Ces renseignements sont sans garantie. Les consignes relatives à la bonne mise en service de la grue sont disponibles dans le manuel d'utilisation et le manuel de tableaux de charge.

### Proposition 65



**WARNING:** This product can expose you to chemicals, including exhaust emissions, including lead and lead compounds, which are known to the State of California to cause cancer, birth defects or other reproductive harm.  
For more information see: [www.P65warnings.ca.gov/diesel](http://www.P65warnings.ca.gov/diesel)

Subject to modification / Sous réserve de modifications